

## Features

- 100 MHz gain-bandwidth product
- Gain-of-2 stable
- Low supply current  
= 5.2 mA at  $V_S = \pm 15V$
- Wide supply range  
=  $\pm 2V$  to  $\pm 18V$  dual-supply  
= 2.5V to 36V single-supply
- High slew rate = 275 V/ $\mu s$
- Fast settling = 80 ns to 0.1% for a 10V step
- Low differential gain = 0.02% at  $A_V = +2$ ,  $R_L = 150\Omega$
- Low differential phase = 0.07° at  $A_V = +2$ ,  $R_L = 150\Omega$
- Stable with unlimited capacitive load
- Wide output voltage swing  
=  $\pm 13.6V$  with  $V_S = \pm 15V$ ,  
 $R_L = 1000\Omega$   
= 3.8V/0.3V with  $V_S = +5V$ ,  
 $R_L = 500\Omega$

## Applications

- Video amplifier
- Single-supply amplifier
- Active filters/integrators
- High-speed sample-and-hold
- High-speed signal processing
- ADC/DAC buffer
- Pulse/RF amplifier
- Pin diode receiver
- Log amplifier
- Photo multiplier amplifier
- Difference amplifier

## Ordering Information

Part No.	Temp. Range	Package	Outline #
EL2045CN	0°C to +75°C	8-Pin P-DIP	MDP0031
EL2045CS	0°C to +75°C	8-Lead SO	MDP0027

## General Description

The EL2045C is a high speed, low power, low cost monolithic operational amplifier built on Elantec's proprietary complementary bipolar process. The EL2045C is gain-of-2 stable and features a 275 V/ $\mu s$  slew rate and 100 MHz gain-bandwidth product while requiring only 5.2 mA of supply current.

The power supply operating range of the EL2045C is from  $\pm 18V$  down to as little as  $\pm 2V$ . For single-supply operation, the EL2045C operates from 36V down to as little as 2.5V. The excellent power supply operating range of the EL2045C makes it an obvious choice for applications on a single +5V or +3V supply.

The EL2045C also features an extremely wide output voltage swing of  $\pm 13.6V$  with  $V_S = \pm 15V$  and  $R_L = 1000\Omega$ . At  $\pm 5V$ , output voltage swing is a wide  $\pm 3.8V$  with  $R_L = 500\Omega$  and  $\pm 3.2V$  with  $R_L = 150\Omega$ . Furthermore, for single-supply operation at +5V, output voltage swing is an excellent 0.3V to 3.8V with  $R_L = 500\Omega$ .

At a gain of +2, the EL2045C has a -3 dB bandwidth of 100 MHz with a phase margin of 50°. It can drive unlimited load capacitance, and because of its conventional voltage-feedback topology, the EL2045C allows the use of reactive or non-linear elements in its feedback network. This versatility combined with low cost and 75 mA of output-current drive makes the EL2045C an ideal choice for price-sensitive applications requiring low power and high speed.

## Connection Diagram

DIP and SO Package

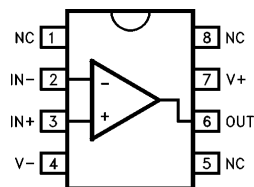

2045-1

# EL2045C

## Low-Power 100 MHz Gain-of-2 Stable Operational Amplifier

### Absolute Maximum Ratings ( $T_A = 25^\circ\text{C}$ )

Supply Voltage ( $V_S$ )	$\pm 18\text{V}$ or $36\text{V}$	Power Dissipation ( $P_D$ )	See Curves
Peak Output Current ( $I_{OP}$ )	Short-Circuit Protected	Operating Temperature Range ( $T_A$ )	$0^\circ\text{C}$ to $+75^\circ\text{C}$
Output Short-Circuit Duration (Note 1)	Infinite	Operating Junction Temperature ( $T_J$ )	$150^\circ\text{C}$
Input Voltage ( $V_{IN}$ )	$\pm V_S$	Storage Temperature ( $T_{ST}$ )	$-65^\circ\text{C}$ to $+150^\circ\text{C}$
Differential Input Voltage ( $dV_{IN}$ )	$\pm 10\text{V}$		

#### Important Note:

All parameters having Min/Max specifications are guaranteed. The Test Level column indicates the specific device testing actually performed during production and Quality inspection. Elantec performs most electrical tests using modern high-speed automatic test equipment, specifically the LTX77 Series system. Unless otherwise noted, all tests are pulsed tests, therefore  $T_J = T_C = T_A$ .

Test Level	Test Procedure
I	100% production tested and QA sample tested per QA test plan QCX0002.
II	100% production tested at $T_A = 25^\circ\text{C}$ and QA sample tested at $T_A = 25^\circ\text{C}$ , $T_{MAX}$ and $T_{MIN}$ per QA test plan QCX0002.
III	QA sample tested per QA test plan QCX0002.
IV	Parameter is guaranteed (but not tested) by Design and Characterization Data.
V	Parameter is typical value at $T_A = 25^\circ\text{C}$ for information purposes only.

### DC Electrical Characteristics $V_S = \pm 15\text{V}$ , $R_L = 1000\Omega$ , unless otherwise specified

Parameter	Description	Condition	Temp	Min	Typ	Max	Test Level	Units
$V_{OS}$	Input Offset Voltage	$V_S = \pm 15\text{V}$	$25^\circ\text{C}$		0.5	7.0	I	mV
			$T_{MIN}, T_{MAX}$			9.0	III	mV
$TCV_{OS}$	Average Offset Voltage Drift	(Note 2)	All		10.0		V	$\mu\text{V}/^\circ\text{C}$
$I_B$	Input Bias Current	$V_S = \pm 15\text{V}$	$25^\circ\text{C}$		2.8	8.2	I	$\mu\text{A}$
			$T_{MIN}, T_{MAX}$			9.2	III	$\mu\text{A}$
		$V_S = \pm 5\text{V}$	$25^\circ\text{C}$		2.8		V	$\mu\text{A}$
$I_{OS}$	Input Offset Current	$V_S = \pm 15\text{V}$	$25^\circ\text{C}$		50	300	I	nA
			$T_{MIN}, T_{MAX}$			400	III	nA
		$V_S = \pm 5\text{V}$	$25^\circ\text{C}$		50		V	nA
$TCI_{OS}$	Average Offset Current Drift	(Note 2)	All		0.3		V	$\text{nA}/^\circ\text{C}$
$A_{VOL}$	Open-Loop Gain	$V_S = \pm 15\text{V}, V_{OUT} = \pm 10\text{V}, R_L = 1000\Omega$	$25^\circ\text{C}$	1500	3000		I	V/V
			$T_{MIN}, T_{MAX}$	1500			III	V/V
		$V_S = \pm 5\text{V}, V_{OUT} = \pm 2.5\text{V}, R_L = 500\Omega$	$25^\circ\text{C}$		2500		V	V/V
		$V_S = \pm 5\text{V}, V_{OUT} = \pm 2.5\text{V}, R_L = 150\Omega$	$25^\circ\text{C}$		1750		V	V/V
PSRR	Power Supply Rejection Ratio	$V_S = \pm 5\text{V}$ to $\pm 15\text{V}$	$25^\circ\text{C}$	65	85		I	dB
			$T_{MIN}, T_{MAX}$	60			III	dB

# EL2045C

## Low-Power 100 MHz Gain-of-2 Stable Operational Amplifier

### DC Electrical Characteristics $V_S = \pm 15V, R_L = 1000\Omega$ , unless otherwise specified — Contd.

Parameter	Description	Condition	Temp	Min	Typ	Max	Test Level	Units
CMRR	Common-Mode Rejection Ratio	$V_{CM} = \pm 12V, V_{OUT} = 0V$	25°C	70	95		I	dB
			$T_{MIN}, T_{MAX}$	70			III	dB
CMIR	Common-Mode Input Range	$V_S = \pm 15V$	25°C		$\pm 14.0$		V	V
		$V_S = \pm 5V$	25°C		$\pm 4.2$		V	V
		$V_S = +5V$	25°C		4.2/0.1		V	V
V <sub>OUT</sub>	Output Voltage Swing	$V_S = \pm 15V, R_L = 1000\Omega$	25°C	$\pm 13.4$	$\pm 13.6$		I	V
			$T_{MIN}, T_{MAX}$	$\pm 13.1$			III	V
		$V_S = \pm 15V, R_L = 500\Omega$	25°C	$\pm 12.0$	$\pm 13.4$		I	V
		$V_S = \pm 5V, R_L = 500\Omega$	25°C	$\pm 3.4$	$\pm 3.8$		IV	V
		$V_S = \pm 5V, R_L = 150\Omega$	25°C		$\pm 3.2$		V	V
		$V_S = +5V, R_L = 500\Omega$	25°C	3.6/0.4	3.8/0.3		I	V
			$T_{MIN}, T_{MAX}$	3.5/0.5			III	V
I <sub>SC</sub>	Output Short Circuit Current		25°C	40	75		I	mA
			$T_{MIN}, T_{MAX}$	35			III	mA
I <sub>S</sub>	Supply Current	$V_S = \pm 15V, \text{No Load}$	25°C		5.2	7	I	mA
			$T_{MIN}, T_{MAX}$			7.6	III	mA
R <sub>IN</sub>	Input Resistance	Differential	25°C		150		V	k $\Omega$
		Common-Mode	25°C		15		V	M $\Omega$
C <sub>IN</sub>	Input Capacitance	$A_V = +2 @ 10 \text{ MHz}$	25°C		1.0		V	pF
R <sub>OUT</sub>	Output Resistance	$A_V = +2$	25°C		50		V	m $\Omega$
PSOR	Power-Supply Operating Range	Dual-Supply	25°C	$\pm 2.0$		$\pm 18.0$	V	V
		Single-Supply	25°C	2.5		36.0	V	V

### Closed-Loop AC Electrical Characteristics

$V_S = \pm 15V, A_V = +2, R_f = R_g = 1 \text{ k}\Omega, C_f = 3 \text{ pF}, R_L = 1000\Omega$  unless otherwise specified

Parameter	Description	Condition	Temp	Min	Typ	Max	Test Level	Units
BW	-3 dB Bandwidth ( $V_{OUT} = 0.4 V_{PP}$ )	$V_S = \pm 15V, A_V = +2$	25°C		100		V	MHz
		$V_S = \pm 15V, A_V = -1$	25°C		75		V	MHz
		$V_S = \pm 15V, A_V = +5$	25°C		20		V	MHz
		$V_S = \pm 15V, A_V = +10$	25°C		10		V	MHz
		$V_S = \pm 15V, A_V = +20$	25°C		5		V	MHz
		$V_S = \pm 5V, A_V = +2$	25°C		75		V	MHz
GBWP	Gain-Bandwidth Product	$V_S = \pm 15V$	25°C		100		V	MHz
		$V_S = \pm 5V$	25°C		75		V	MHz
PM	Phase Margin	$R_L = 1 \text{ k}\Omega, C_L = 10 \text{ pF}$	25°C		50		V	°

# EL2045C

## Low-Power 100 MHz Gain-of-2 Stable Operational Amplifier

### Closed-Loop AC Electrical Characteristics

$V_S = \pm 15V$ ,  $A_V = +2$ ,  $R_f = R_g = 1\text{ k}\Omega$ ,  $C_f = 3\text{ pF}$ ,  $R_L = 1000\Omega$ , unless otherwise specified — Contd.

Parameter	Description	Condition	Temp	Min	Typ	Max	Test Level	Units
SR	Slew Rate (Note 3)	$V_S = \pm 15V$ , $R_L = 1000\Omega$	25°C	200	275		I	V/ $\mu$ s
		$V_S = \pm 5V$ , $R_L = 500\Omega$	25°C		200		V	V/ $\mu$ s
FPBW	Full-Power Bandwidth (Note 4)	$V_S = \pm 15V$	25°C	3.2	4.4		I	MHz
		$V_S = \pm 5V$	25°C		12.7		V	MHz
$t_r, t_f$	Rise Time, Fall Time	0.1V Output Step	25°C		3.0		V	ns
OS	Overshoot	0.1V Output Step	25°C		20		V	%
$t_{PD}$	Propagation Delay		25°C		2.5		V	ns
$t_s$	Settling to +0.1% ( $A_V = +2$ )	$V_S = \pm 15V$ , 10V Step	25°C		80		V	ns
		$V_S = \pm 5V$ , 5V Step	25°C		60		V	ns
dG	Differential Gain (Note 5)	NTSC/PAL	25°C		0.02		V	%
dP	Differential Phase (Note 5)	NTSC/PAL	25°C		0.07		V	°
eN	Input Noise Voltage	10 kHz	25°C		15.0		V	nV/ $\sqrt{\text{Hz}}$
iN	Input Noise Current	10 kHz	25°C		1.50		V	pA/ $\sqrt{\text{Hz}}$
CI STAB	Load Capacitance Stability	$A_V = +2$	25°C		Infinite		V	pF

Note 1: A heat-sink is required to keep junction temperature below absolute maximum when an output is shorted.

Note 2: Measured from  $T_{MIN}$  to  $T_{MAX}$ .

Note 3: Slew rate is measured on rising edge.

Note 4: For  $V_S = \pm 15V$ ,  $V_{OUT} = 20\text{ V}_{PP}$ . For  $V_S = \pm 5V$ ,  $V_{OUT} = 5\text{ V}_{PP}$ . Full-power bandwidth is based on slew rate measurement using:  $FPBW = SR / (2\pi * V_{peak})$ .

Note 5: Video Performance measured at  $V_S = \pm 15V$ ,  $A_V = +2$  with 2 times normal video level across  $R_L = 150\Omega$ . This corresponds to standard video levels across a back-terminated  $75\Omega$  load. For other values of  $R_L$ , see curves.

EL2045C Test Circuit

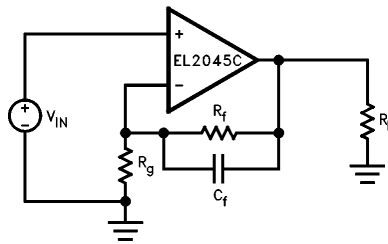

2045-2

# EL2045C

## Low-Power 100 MHz Gain-of-2 Stable Operational Amplifier

### Typical Performance Curves

( $T_A = 25^\circ\text{C}$ ,  $R_f = 1\text{ k}\Omega$ ,  $C_f = 3\text{ pF}$ ,  $R_L = 1000\Omega$ ,  $A_V = +2$  unless otherwise specified)

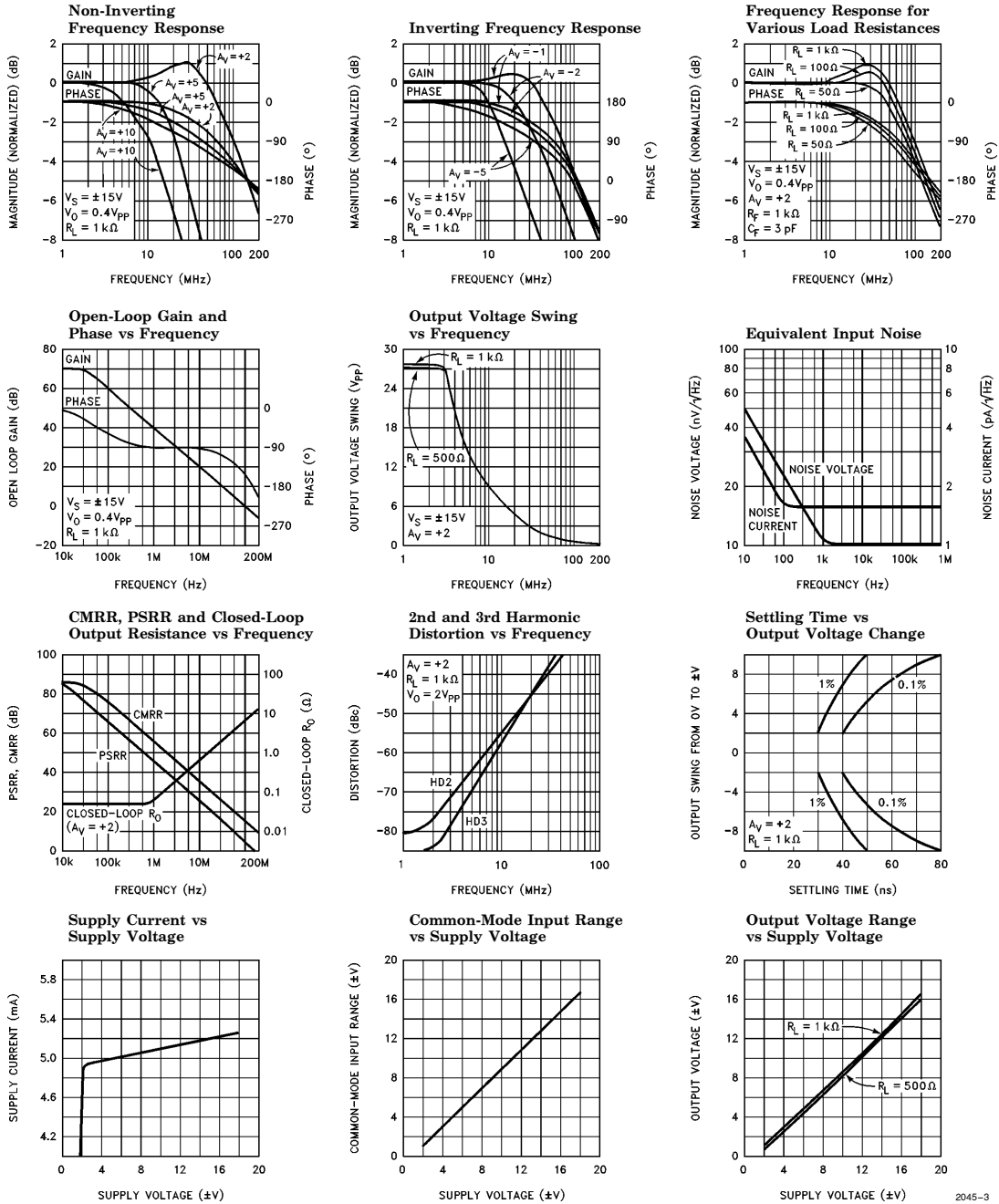

# EL2045C

## Low-Power 100 MHz Gain-of-2 Stable Operational Amplifier

### Typical Performance Curves

( $T_A = 25^\circ\text{C}$ ,  $R_f = 1\text{ k}\Omega$ ,  $C_f = 3\text{ pF}$ ,  $R_L = 1000\Omega$ ,  $A_V = +2$  unless otherwise specified) — Contd.

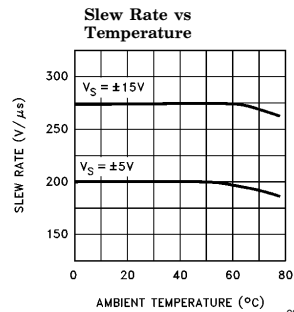
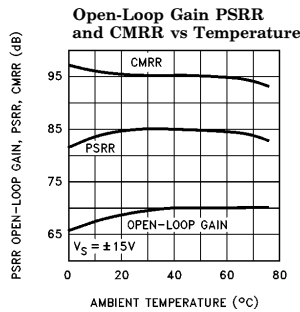
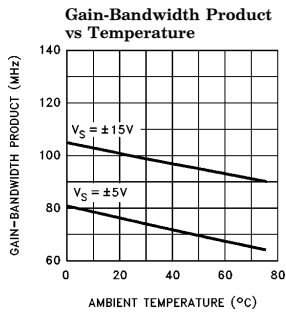
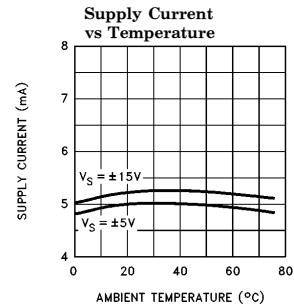
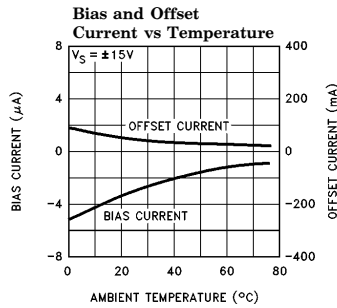
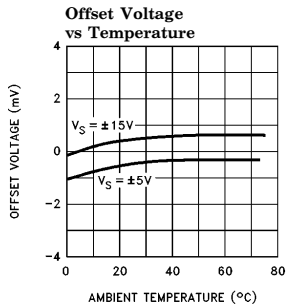
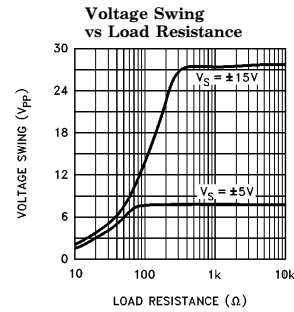
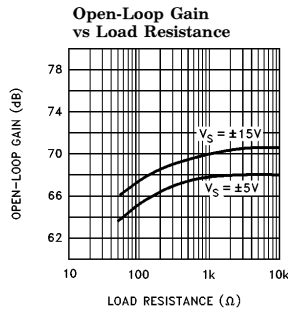
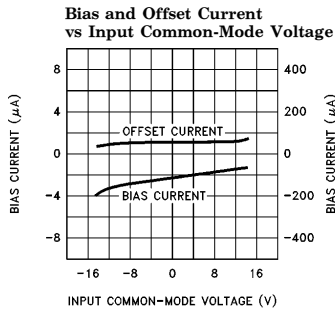
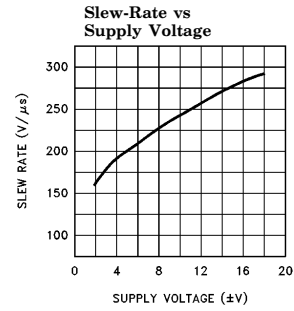
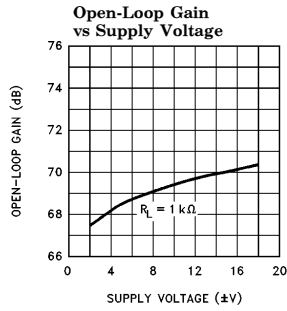
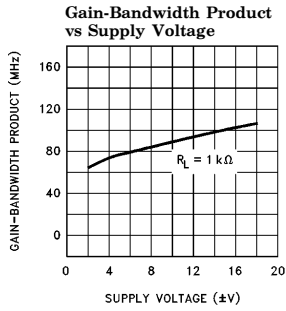

2045-4

# EL2045C

## Low-Power 100 MHz Gain-of-2 Stable Operational Amplifier

### Typical Performance Curves

( $T_A = 25^\circ\text{C}$ ,  $R_f = 1\text{ k}\Omega$ ,  $C_f = 3\text{ pF}$ ,  $R_L = 1000\Omega$ ,  $A_V = +2$  unless otherwise specified) — Contd.

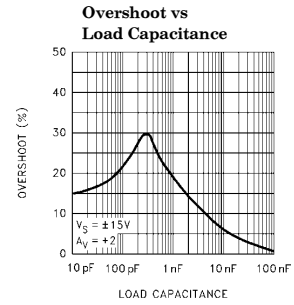
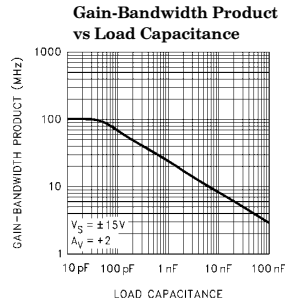
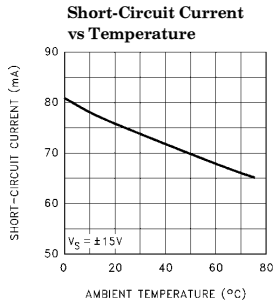

**Small-Signal Step Response**

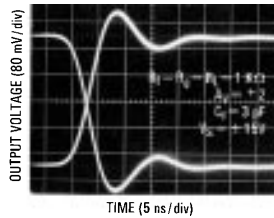

**Large-Signal Step Response**

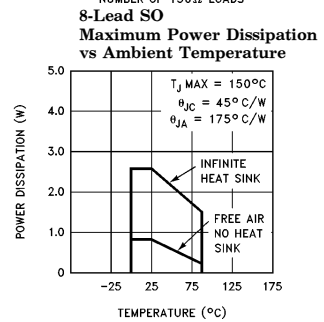
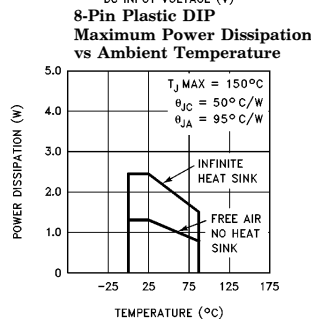
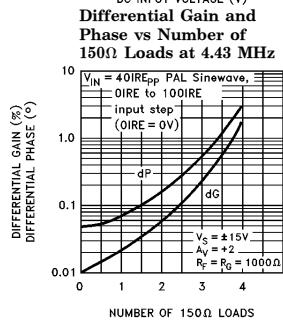
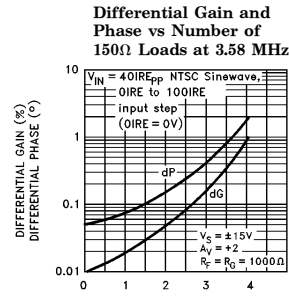
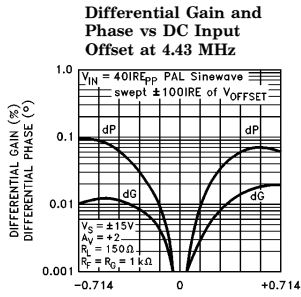
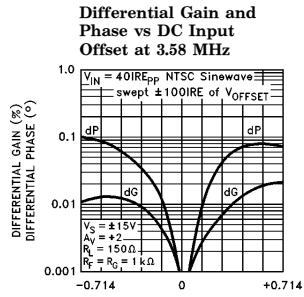
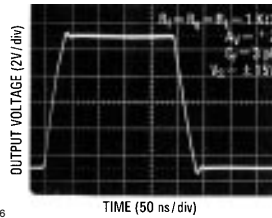

# EL2045C

Low-Power 100 MHz Gain-of-2 Stable Operational Amplifier

## Simplified Schematic

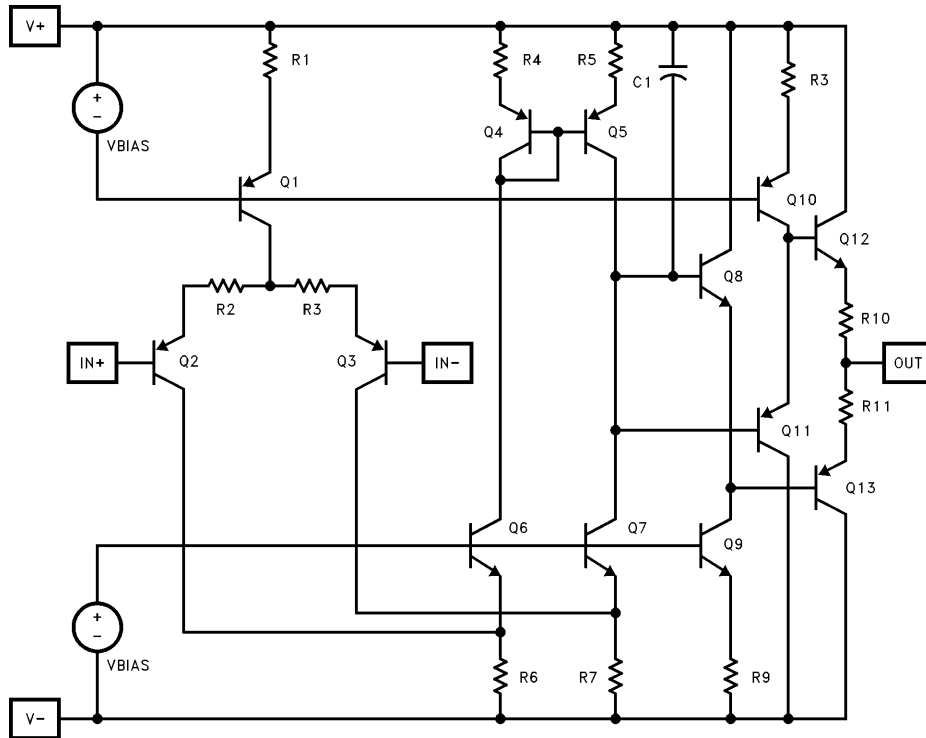

2045-9



# EL2045C

## Low-Power 100 MHz Gain-of-2 Stable Operational Amplifier

### Burn-In Circuit

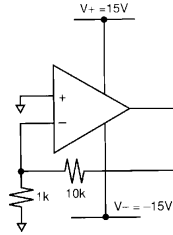

All Packages Use the Same Schematic

### Applications Information

#### Product Description

The EL2045C is a low-power wideband, gain-of-2 stable monolithic operational amplifier built on Elantec's proprietary high-speed complementary bipolar process. The EL2045C uses a classical voltage-feedback topology which allows it to be used in a variety of applications where current-feedback amplifiers are not appropriate because of restrictions placed upon the feedback element used with the amplifier. The conventional topology of the EL2045C allows, for example, a capacitor to be placed in the feedback path, making it an excellent choice for applications such as active filters, sample-and-holds, or integrators. Similarly, because of the ability to use diodes in the feedback network, the EL2045C is an excellent choice for applications such as fast log amplifiers.

#### Single-Supply Operation

The EL2045C has been designed to have a wide input and output voltage range. This design also makes the EL2045C an excellent choice for single-supply operation. Using a single positive supply, the lower input voltage range is within 100 mV of ground ( $R_L = 500\Omega$ ), and the lower output voltage range is within 300 mV of ground. Upper input voltage range reaches 4.2V, and output voltage range reaches 3.8V with a 5V supply and  $R_L = 500\Omega$ . This results in a 3.5V output swing on a single 5V supply. This wide output voltage range also allows single-supply operation with a supply voltage as high as 36V or as low as 2.5V. On a single 2.5V supply, the EL2045C still has 1V of output swing.

### Gain-Bandwidth Product and the -3 dB Bandwidth

The EL2045C has a gain-bandwidth product of 100 MHz while using only 5.2 mA of supply current. For gains greater than 4, its closed-loop -3 dB bandwidth is approximately equal to the gain-bandwidth product divided by the noise gain of the circuit. For gains less than 4, higher-order poles in the amplifier's transfer function contribute to even higher closed loop bandwidths. For example, the EL2045C has a -3 dB bandwidth of 100 MHz at a gain of +2, dropping to 20 MHz at a gain of +5. It is important to note that the EL2045C has been designed so that this "extra" bandwidth in low-gain applications does not come at the expense of stability. As seen in the typical performance curves, the EL2045C in a gain of +2 only exhibits 1.0 dB of peaking with a 1000 $\Omega$  load.

### Video Performance

An industry-standard method of measuring the video distortion of a component such as the EL2045C is to measure the amount of differential gain (dG) and differential phase (dP) that it introduces. To make these measurements, a 0.286 V<sub>PP</sub> (40 IRE) signal is applied to the device with 0V DC offset (0 IRE) at either 3.58 MHz for NTSC or 4.43 MHz for PAL. A second measurement is then made at 0.714V DC offset (100 IRE). Differential gain is a measure of the change in amplitude of the sine wave, and is measured in percent. Differential phase is a measure of the change in phase, and is measured in degrees.

For signal transmission and distribution, a back-terminated cable (75 $\Omega$  in series at the drive end, and 75 $\Omega$  to ground at the receiving end) is preferred since the impedance match at both ends will absorb any reflections. However, when double termination is used, the received signal is halved; therefore a gain of 2 configuration is typically used to compensate for the attenuation.

The EL2045C has been designed as an economical solution for applications requiring low video distortion. It has been thoroughly characterized

# **EL2045C**

## **Low-Power 100 MHz Gain-of-2 Stable Operational Amplifier**

### **Applications Information — Contd.**

for video performance in the topology described above, and the results have been included as typical dG and dP specifications and as typical performance curves. In a gain of +2, driving 150Ω, with standard video test levels at the input, the EL2045C exhibits dG and dP of only 0.02% and 0.07° at NTSC and PAL. Because dG and dP can vary with different DC offsets, the video performance of the EL2045C has been characterized over the entire DC offset range from -0.714V to +0.714V. For more information, refer to the curves of dG and dP vs DC Input Offset.

The output drive capability of the EL2045C allows it to drive up to 2 back-terminated loads with good video performance. For more demanding applications such as greater output drive or better video distortion, a number of alternatives such as the EL2120, EL400, or EL2074 should be considered.

### **Output Drive Capability**

The EL2045C has been designed to drive low impedance loads. It can easily drive 6 V<sub>pp</sub> into a 150Ω load. This high output drive capability makes the EL2045C an ideal choice for RF, IF and video applications. Furthermore, the current drive of the EL2045C remains a minimum of 35 mA at low temperatures. The EL2045C is current-limited at the output, allowing it to withstand shorts to ground. However, power dissipation with the output shorted can be in excess of the power-dissipation capabilities of the package.

### **Capacitive Loads**

For ease of use, the EL2045C has been designed to drive any capacitive load. However, the EL2045C remains stable by automatically reducing its gain-bandwidth product as capacitive load increases. Therefore, for maximum bandwidth, capacitive loads should be reduced as much as possible or isolated via a series output resistor (R<sub>s</sub>). Similarly, coax lines can be driven, but best AC performance is obtained when they are terminated with their characteristic impedance so that the capacitance of the coaxial cable will not add to the capacitive load seen by the amplifier. Al-

though stable with all capacitive loads, some peaking still occurs as load capacitance increases. A series resistor at the output of the EL2045C can be used to reduce this peaking and further improve stability.

### **Printed-Circuit Layout**

The EL2045C is well behaved, and easy to apply in most applications. However, a few simple techniques will help assure rapid, high quality results. As with any high-frequency device, good PCB layout is necessary for optimum performance. Ground-plane construction is highly recommended, as is good power supply bypassing. A 0.1 μF ceramic capacitor is recommended for bypassing both supplies. Lead lengths should be as short as possible, and bypass capacitors should be as close to the device pins as possible. For good AC performance, parasitic capacitances should be kept to a minimum at both inputs and at the output. Resistor values should be kept under 5 kΩ because of the RC time constants associated with the parasitic capacitance. Metal-film and carbon resistors are both acceptable, use of wire-wound resistors is not recommended because of their parasitic inductance. Similarly, capacitors should be low-inductance for best performance.

### **The EL2045C Macromodel**

This macromodel has been developed to assist the user in simulating the EL2045C with surrounding circuitry. It has been developed for the PSPICE simulator (copyrighted by the Microsim Corporation), and may need to be rearranged for other simulators. It approximates DC, AC, and transient response for resistive loads, but does not accurately model capacitive loading. This model is slightly more complicated than the models used for low-frequency op-amps, but it is much more accurate for AC analysis.

The model does not simulate these characteristics accurately:

noise	non-linearities
settling-time	temperature effects
CMRR	manufacturing variations
PSRR	

# ***EL2045C***

## ***Low-Power 100 MHz Gain-of-2 Stable Operational Amplifier***

### **EL2045C Macromodel — Contd.**

```

* Connections:      + input
*                  |
*                  | -input
*                  |
*                  | + Vsupply
*                  | |
*                  | | - Vsupply
*                  | |
*                  | | output
*                  | |
.subckt M2045      3  2  7  4  6
*
* Input stage
*
ie 7 37 0.9mA
r6 36 37 400
r7 38 37 400
rc1 4 30 850
rc2 4 39 850
q1 30 3 36 qp
q2 39 2 38 qpa
ediff 33 0 39 30 1.0
rdiff 33 0 1Meg
*
* Compensation Section
*
ga 0 34 33 0 1m
rh 34 0 2Meg
ch 34 0 1.5pF
rc 34 40 1K
cc 40 0 1pF
*
* Poles
*
ep 41 0 40 0 1
rpa 41 42 200
cpa 42 0 2pF
rpb 42 43 200
cpb 43 0 2pF
*
* Output Stage
*
ios1 7 50 1.0mA
ios2 51 4 1.0mA
q3 4 43 50 qp
q4 7 43 51 qn
q5 7 50 52 qn
q6 4 51 53 qp
ros1 52 6 25
ros2 6 53 25
*
* Power Supply Current
*
ips 7 4 2.7mA
*
* Models
*
.model qn npn(is = 800E-18 bf = 200 tf = 0.2nS)
.model qpa pnp(is = 864E-18 bf = 100 tf = 0.2nS)
.model qp pnp(is = 800E-18 bf = 125 tf = 0.2nS)
.ends

```

# EL2045C

## Low-Power 100 MHz Gain-of-2 Stable Operational Amplifier

### EL2045C Macromodel — Contd.

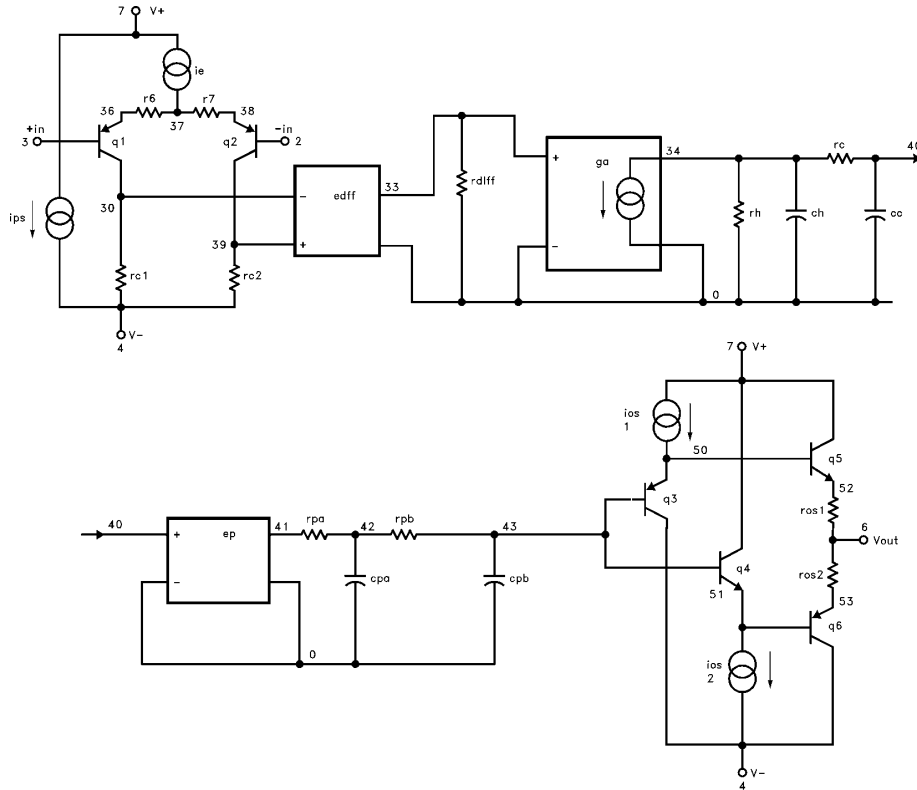

EL2045C Model

2045-11

#### General Disclaimer

Specifications contained in this data sheet are in effect as of the publication date shown. Elantec, Inc. reserves the right to make changes in the circuitry or specifications contained herein at any time without notice. Elantec, Inc. assumes no responsibility for the use of any circuits described herein and makes no representations that they are free from patent infringement.

**élan**tec  
HIGH PERFORMANCE ANALOG INTEGRATED CIRCUITS

#### Elantec, Inc.

1996 Tarob Court

Milpitas, CA 95035

Telephone: (408) 945-1323

(800) 333-6314

Fax: (408) 945-9305

European Office: 44-71-482-4596

#### WARNING — Life Support Policy

Elantec, Inc. products are not authorized for and should not be used within Life Support Systems without the specific written consent of Elantec, Inc. Life Support systems are equipment intended to support or sustain life and whose failure to perform when properly used in accordance with instructions provided can be reasonably expected to result in significant personal injury or death. Users contemplating application of Elantec, Inc. products in Life Support Systems are requested to contact Elantec, Inc. factory headquarters to establish suitable terms & conditions for these applications. Elantec, Inc.'s warranty is limited to replacement of defective components and does not cover injury to persons or property or other consequential damages.