

LF444 Quad Low Power JFET Input Operational Amplifier

General Description

The LF444 quad low power operational amplifier provides many of the same AC characteristics as the industry standard LM148 while greatly improving the DC characteristics of the LM148. The amplifier has the same bandwidth, slew rate, and gain (10 k Ω load) as the LM148 and only draws one fourth the supply current of the LM148. In addition the well matched high voltage JFET input devices of the LF444 reduce the input bias and offset currents by a factor of 10,000 over the LM148. The LF444 also has a very low equivalent input noise voltage for a low power amplifier.

The LF444 is pin compatible with the LM148 allowing an immediate 4 times reduction in power drain in many applications. The LF444 should be used wherever low power dissipation and good electrical characteristics are the major considerations.

Features

- $\frac{1}{4}$ supply current of a LM148 200 $\mu\text{A}/\text{Amplifier (max)}$
- Low input bias current 50 pA (max)
- High gain bandwidth 1 MHz
- High slew rate 1 V/ μs
- Low noise voltage for low power 35 nV/ $\sqrt{\text{Hz}}$
- Low input noise current 0.01 pA/ $\sqrt{\text{Hz}}$
- High input impedance $10^{12}\Omega$
- High gain $V_O = \pm 10\text{V}, R_L = 10\text{k}$ 50k (min)

Simplified Schematic

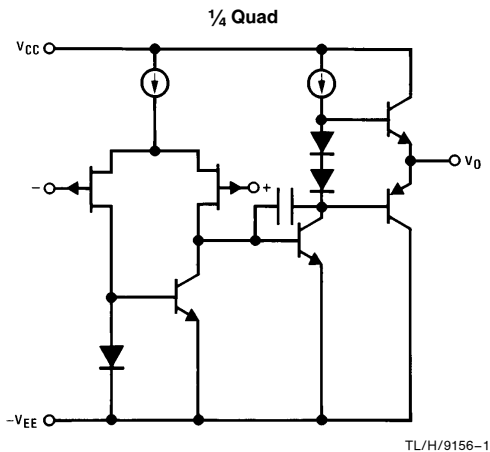

Connection Diagram

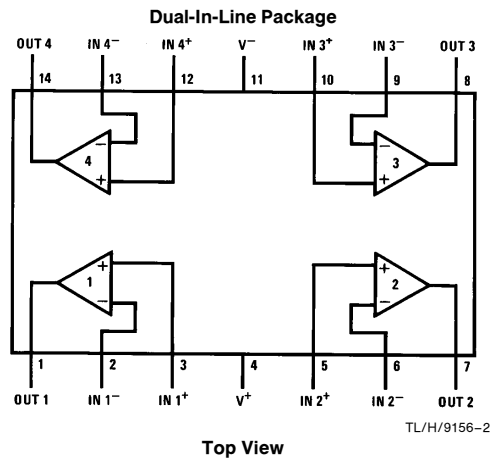

Ordering Information

LF444XYZ

X indicates electrical grade

Y indicates temperature range

"M" for military, "C" for commercial

Z indicates package type "D", "M" or "N"

Order Number LF444AMD, LF444CM,
LF444ACN, LF444CN or LF444MD/883
See NS Package Number D14E, M14A or N14A

Absolute Maximum Ratings

If Military/Aerospace specified devices are required, please contact the National Semiconductor Sales Office/Distributors for availability and specifications.

| | LF444A | LF444 |
|--|------------------|----------------------|
| Supply Voltage | ±22V | ±18V |
| Differential Input Voltage | ±38V | ±30V |
| Input Voltage Range (Note 1) | ±19V | ±15V |
| Output Short Circuit Duration (Note 2) | Continuous | Continuous |
| | D Package | N, M Packages |
| Power Dissipation (Notes 3 and 9) | 900 mW | 670 mW |
| T _j max | 150°C | 115°C |
| θ _{JA} (Typical) | 100°C/W | 85°C/W |

Operating Temperature Range

Storage Temperature Range

ESD Tolerance (Note 10)

Soldering Information

Dual-In-Line Packages

(Soldering, 10 sec.)

Small Outline Package

Vapor Phase (60 sec.)

Infrared (15 sec.)

See AN-450 "Surface Mounting Methods and Their Effect on Product Reliability" for other methods of soldering surface mount devices.

LF444A/LF444

(Note 4)

−65°C ≤ T_A ≤ 150°C

Rating to be determined

260°C

215°C

220°C

DC Electrical Characteristics (Note 5)

| Symbol | Parameter | Conditions | LF444A | | | LF444 | | | Units |
|----------------------|------------------------------------|---|------------------------|------------------|-----|------------------|------------|--------|-------|
| | | | Min | Typ | Max | Min | Typ | Max | |
| V _{OS} | Input Offset Voltage | R _S = 10k, T _A = 25°C | | 2 | 5 | | 3 | 10 | mV |
| | | 0°C ≤ T _A ≤ +70°C | | | 6.5 | | | 12 | mV |
| | | −55°C ≤ T _A ≤ +125°C | | | 8 | | | | mV |
| ΔV _{OS} /ΔT | Average TC of Input Offset Voltage | R _S = 10 kΩ | | 10 | | 10 | | μV/°C | |
| I _{OS} | Input Offset Current | V _S = ±15V (Notes 5, 6) | T _j = 25°C | 5 | 25 | 5 | 50 | pA | |
| | | | T _j = 70°C | | 1.5 | | 1.5 | nA | |
| | | | T _j = 125°C | | 10 | | | nA | |
| I _B | Input Bias Current | V _S = ±15V (Notes 5, 6) | T _j = 25°C | 10 | 50 | 10 | 100 | pA | |
| | | | T _j = 70°C | | 3 | | 3 | nA | |
| | | | T _j = 125°C | | 20 | | | nA | |
| R _{IN} | Input Resistance | T _j = 25°C | | 10 ¹² | | 10 ¹² | | Ω | |
| A _{VOL} | Large Signal Voltage Gain | V _S = ±15V, V _O = ±10V R _L = 10 kΩ, T _A = 25°C | 50 | 100 | | 25 | 100 | V/mV | |
| | | Over Temperature | 25 | | | 15 | | V/mV | |
| V _O | Output Voltage Swing | V _S = ±15V, R _L = 10 kΩ | ±12 | ±13 | | ±12 | ±13 | V | |
| V _{CM} | Input Common-Mode Voltage Range | | ±16 | +18 −17 | | ±11 | +14 −12 | V V | |
| | | | | | | | | | |
| CMRR | Common-Mode Rejection Ratio | R _S ≤ 10 kΩ | 80 | 100 | | 70 | 95 | dB | |
| PSRR | Supply Voltage Rejection Ratio | (Note 7) | 80 | 100 | | 70 | 90 | dB | |
| I _S | Supply Current | | | 0.6 | 0.8 | | 0.6 | 1.0 | mA |

AC Electrical Characteristics (Note 5)

| Symbol | Parameter | Conditions | LF444A | | | LF444 | | | Units |
|--------|---------------------------------|--|--------|------|-----|-------|------|-----|-----------------|
| | | | Min | Typ | Max | Min | Typ | Max | |
| | Amplifier-to-Amplifier Coupling | | | -120 | | | -120 | | dB |
| SR | Slew Rate | $V_S = \pm 15V, T_A = 25^\circ C$ | | 1 | | | 1 | | V/ μs |
| GBW | Gain-Bandwidth Product | $V_S = \pm 15V, T_A = 25^\circ C$ | | 1 | | | 1 | | MHz |
| e_n | Equivalent Input Noise Voltage | $T_A = 25^\circ C, R_S = 100\Omega, f = 1 \text{ kHz}$ | | 35 | | | 35 | | nV/ \sqrt{Hz} |
| i_n | Equivalent Input Noise Current | $T_A = 25^\circ C, f = 1 \text{ kHz}$ | | 0.01 | | | 0.01 | | pA/ \sqrt{Hz} |

Note 1: Unless otherwise specified the absolute maximum negative input voltage is equal to the negative power supply voltage.

Note 2: Any of the amplifier outputs can be shorted to ground indefinitely, however, more than one should not be simultaneously shorted as the maximum junction temperature will be exceeded.

Note 3: For operating at elevated temperature, these devices must be derated based on a thermal resistance of θ_{JA} .

Note 4: The LF444A is available in both the commercial temperature range $0^\circ C \leq T_A \leq 70^\circ C$ and the military temperature range $-55^\circ C \leq T_A \leq 125^\circ C$. The LF444 is available in the commercial temperature range only. The temperature range is designated by the position just before the package type in the device number. A "C" indicates the commercial temperature range and an "M" indicates the military temperature range. The military temperature range is available in "D" package only.

Note 5: Unless otherwise specified the specifications apply over the full temperature range and for $V_S = \pm 20V$ for the LF444A and for $V_S = \pm 15V$ for the LF444. V_{OS} , I_B , and I_{OS} are measured at $V_{CM} = 0$.

Note 6: The input bias currents are junction leakage currents which approximately double for every $10^\circ C$ increase in the junction temperature, T_J . Due to limited production test time, the input bias currents measured are correlated to junction temperature. In normal operation the junction temperature rises above the ambient temperature as a result of internal power dissipation, P_D . $T_J = T_A + \theta_{JA} P_D$ where θ_{JA} is the thermal resistance from junction to ambient. Use of a heat sink is recommended if input bias current is to be kept to a minimum.

Note 7: Supply voltage rejection ratio is measured for both supply magnitudes increasing or decreasing simultaneously in accordance with common practice from $\pm 15V$ to $\pm 5V$ for the LF444 and from $\pm 20V$ to $\pm 5V$ for the LF444A.

Note 8: Refer to RETS444X for LF444MD military specifications.

Note 9: Max. Power Dissipation is defined by the package characteristics. Operating the part near the Max. Power Dissipation may cause the part to operate outside guaranteed limits.

Note 10: Human body model, $1.5 \text{ k}\Omega$ in series with 100 pF .

Typical Performance Characteristics

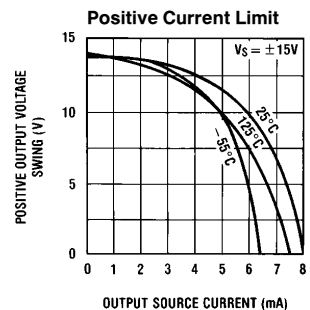
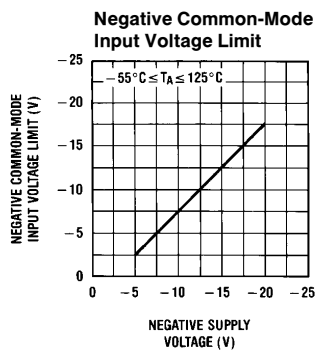
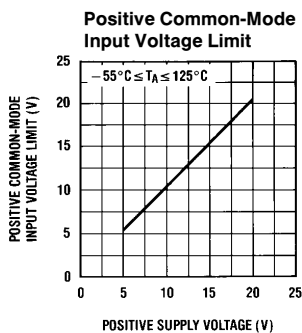
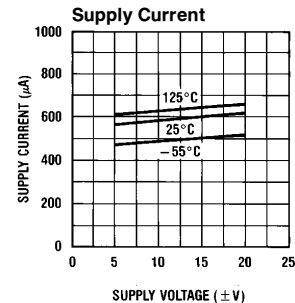
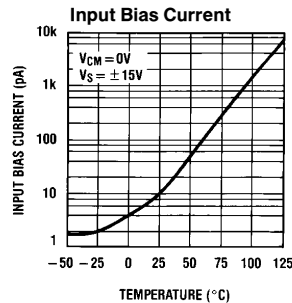
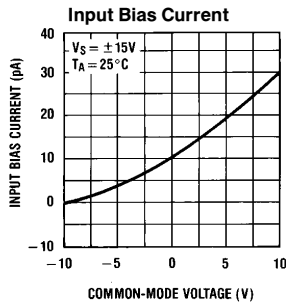

TL/H/9156-3

Typical Performance Characteristics (Continued)

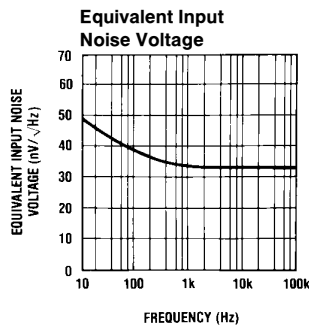
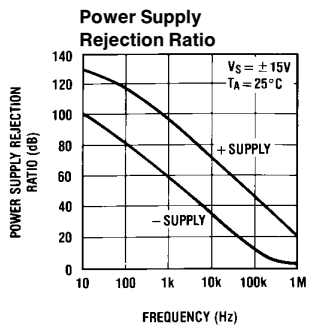
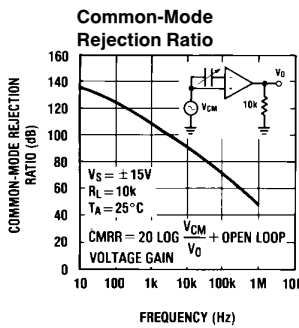
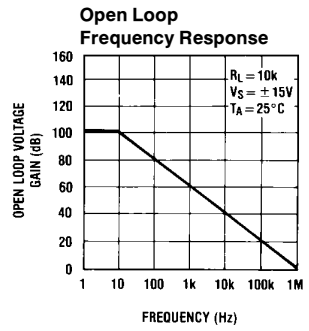
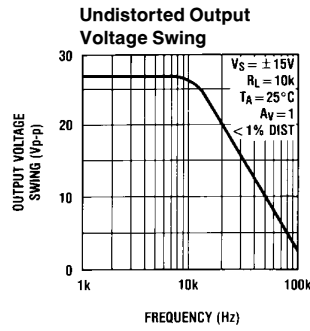
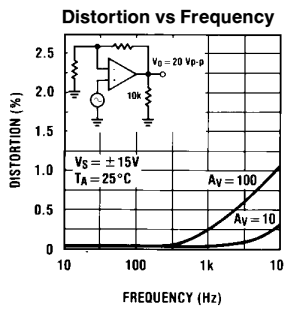
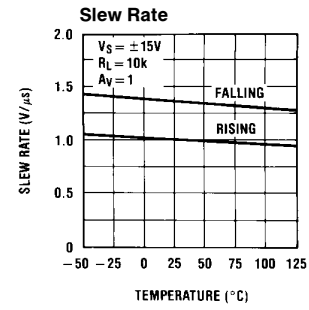
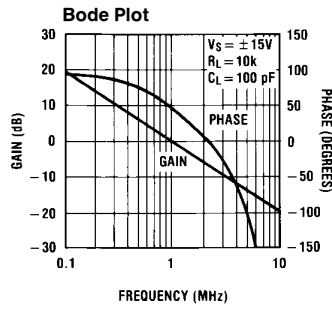
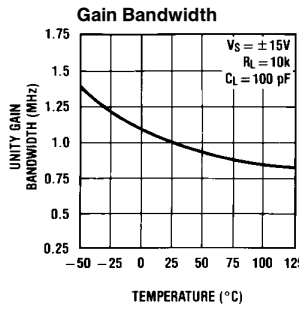
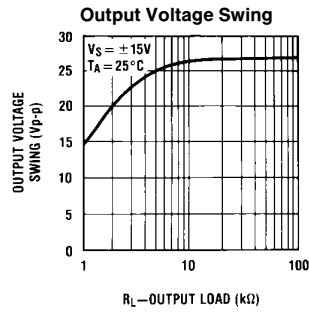
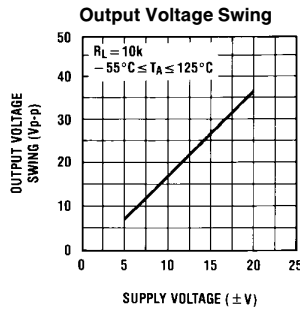
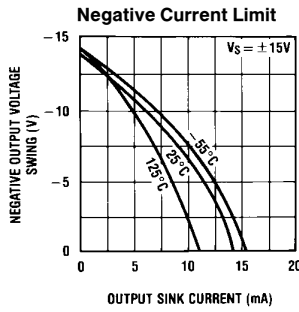

TL/H/9156-4

Typical Performance Characteristics (Continued)

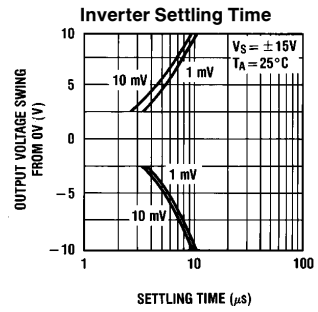
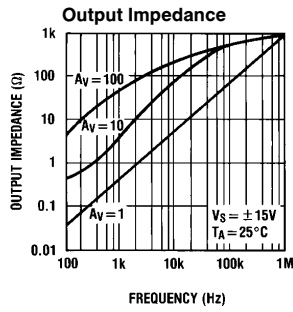
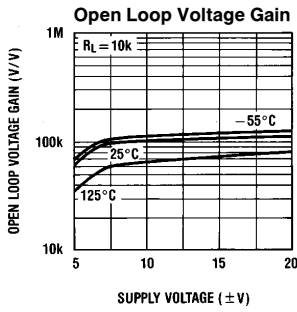

TL/H/9156-5

Pulse Response $R_L = 10 k\Omega$, $C_L = 10 pF$

Small Signal Inverting

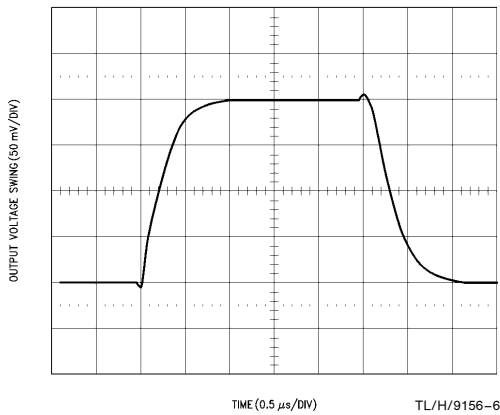

Small Signal Non-Inverting

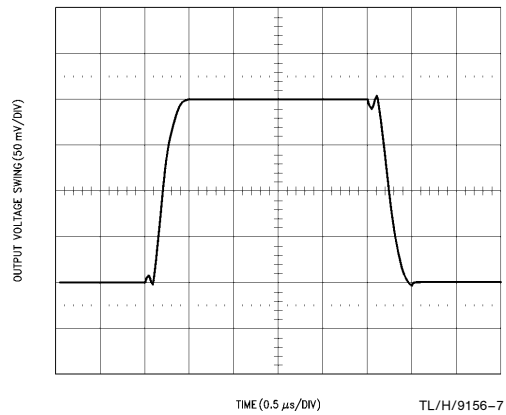

Large Signal Inverting

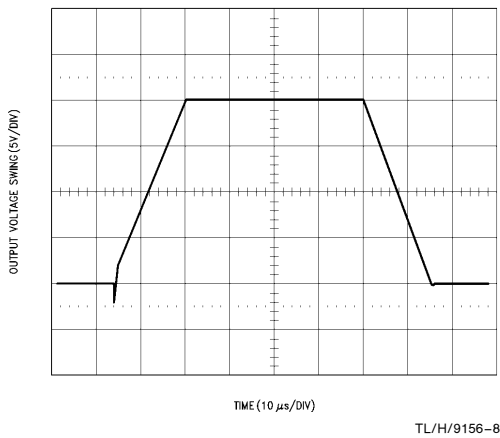

Large Signal Non-Inverting

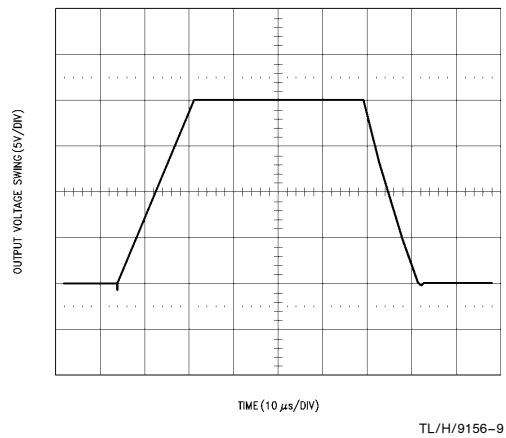

Application Hints

This device is a quad low power op amp with JFET input devices (BI-FET™). These JFETs have large reverse breakdown voltages from gate to source and drain eliminating the need for clamps across the inputs. Therefore, large differential input voltages can easily be accommodated without a large increase in input current. The maximum differential input voltage is independent of the supply voltages. However, neither of the input voltages should be allowed to exceed the negative supply as this will cause large currents to flow which can result in a destroyed unit.

Exceeding the negative common-mode limit on either input will force the output to a high state, potentially causing a reversal of phase to the output. Exceeding the negative common-mode limit on both inputs will force the amplifier output to a high state. In neither case does a latch occur since raising the input back within the common-mode range again puts the input stage and thus the amplifier in a normal operating mode.

Exceeding the positive common-mode limit on a single input will not change the phase of the output; however, if both inputs exceed the limit, the output of the amplifier will be forced to a high state.

The amplifiers will operate with a common-mode input voltage equal to the positive supply; however, the gain bandwidth and slew rate may be decreased in this condition. When the negative common-mode voltage swings to within 3V of the negative supply, an increase in input offset voltage may occur.

Each amplifier is individually biased to allow normal circuit operation with power supplies of $\pm 3.0V$. Supply voltages less than these may degrade the common-mode rejection and restrict the output voltage swing.

The amplifiers will drive a $10\text{ k}\Omega$ load resistance to $\pm 10V$ over the full temperature range. If the amplifier is forced to drive heavier load currents, however, an increase in input offset voltage may occur on the negative voltage swing and finally reach an active current limit on both positive and negative swings.

Precautions should be taken to ensure that the power supply for the integrated circuit never becomes reversed in polarity or that the unit is not inadvertently installed backwards in a socket as an unlimited current surge through the resulting forward diode within the IC could cause fusing of the internal conductors and result in a destroyed unit.

As with most amplifiers, care should be taken with lead dress, component placement and supply decoupling in order to ensure stability. For example, resistors from the output to an input should be placed with the body close to the input to minimize "pick-up" and maximize the frequency of the feedback pole by minimizing the capacitance from the input to ground.

A feedback pole is created when the feedback around any amplifier is resistive. The parallel resistance and capacitance from the input of the device (usually the inverting input) to AC ground set the frequency of the pole. In many instances the frequency of this pole is much greater than the expected 3 dB frequency of the closed loop gain and consequently there is negligible effect on stability margin. However, if the feedback pole is less than approximately 6 times the expected 3 dB frequency a lead capacitor should be placed from the output to the input of the op amp. The value of the added capacitor should be such that the RC time constant of this capacitor and the resistance it parallels is greater than or equal to the original feedback pole time constant.

Typical Application

pH Probe Amplifier/Temperature Compensator

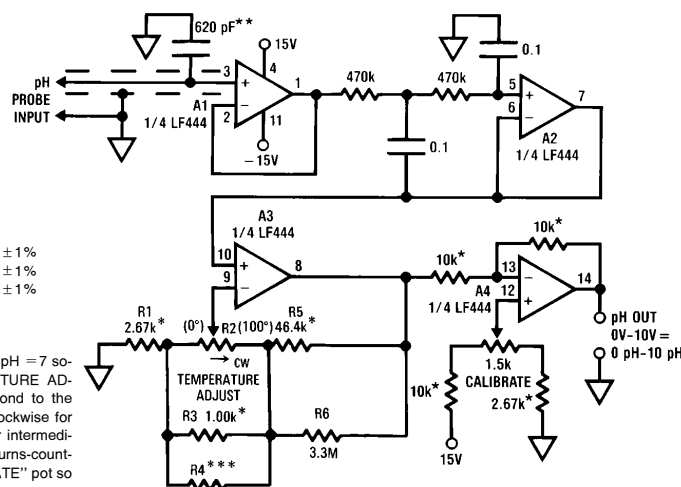

***For $R_2 = 50k$, $R_4 = 330k \pm 1\%$
 For $R_2 = 100k$, $R_4 = 75k \pm 1\%$
 For $R_2 = 200k$, $R_4 = 56k \pm 1\%$

**Polystyrene

*Film resistor type RN60C

To calibrate, insert probe in pH = 7 solution. Set the "TEMPERATURE ADJUST" pot, R_2 , to correspond to the solution temperature: full clockwise for 0°C , and proportionately for intermediate temperatures, using a turns-counting dial. Then set "CALIBRATE" pot so output reads 7V.

Typical probe = Ingold Electrodes #465-35

TL/H/9156-10

Detailed Schematic

1/4 Quad

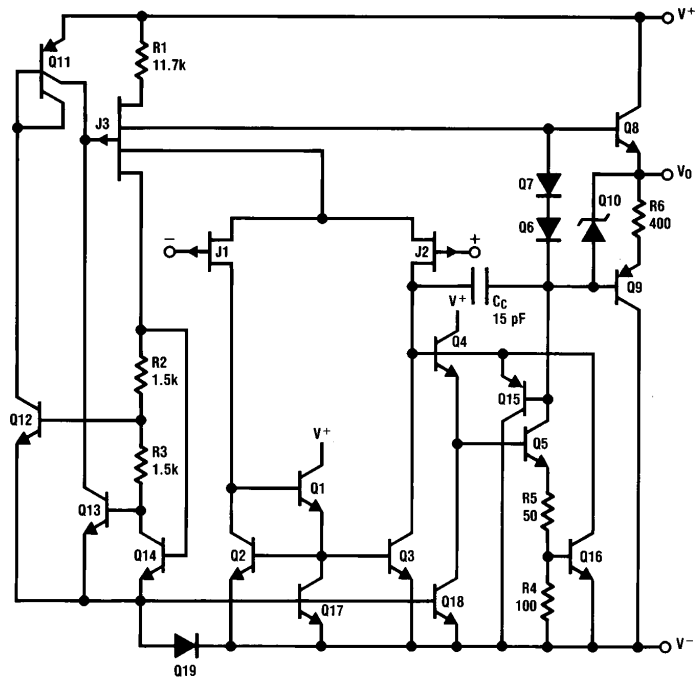

TL/H/9156-11

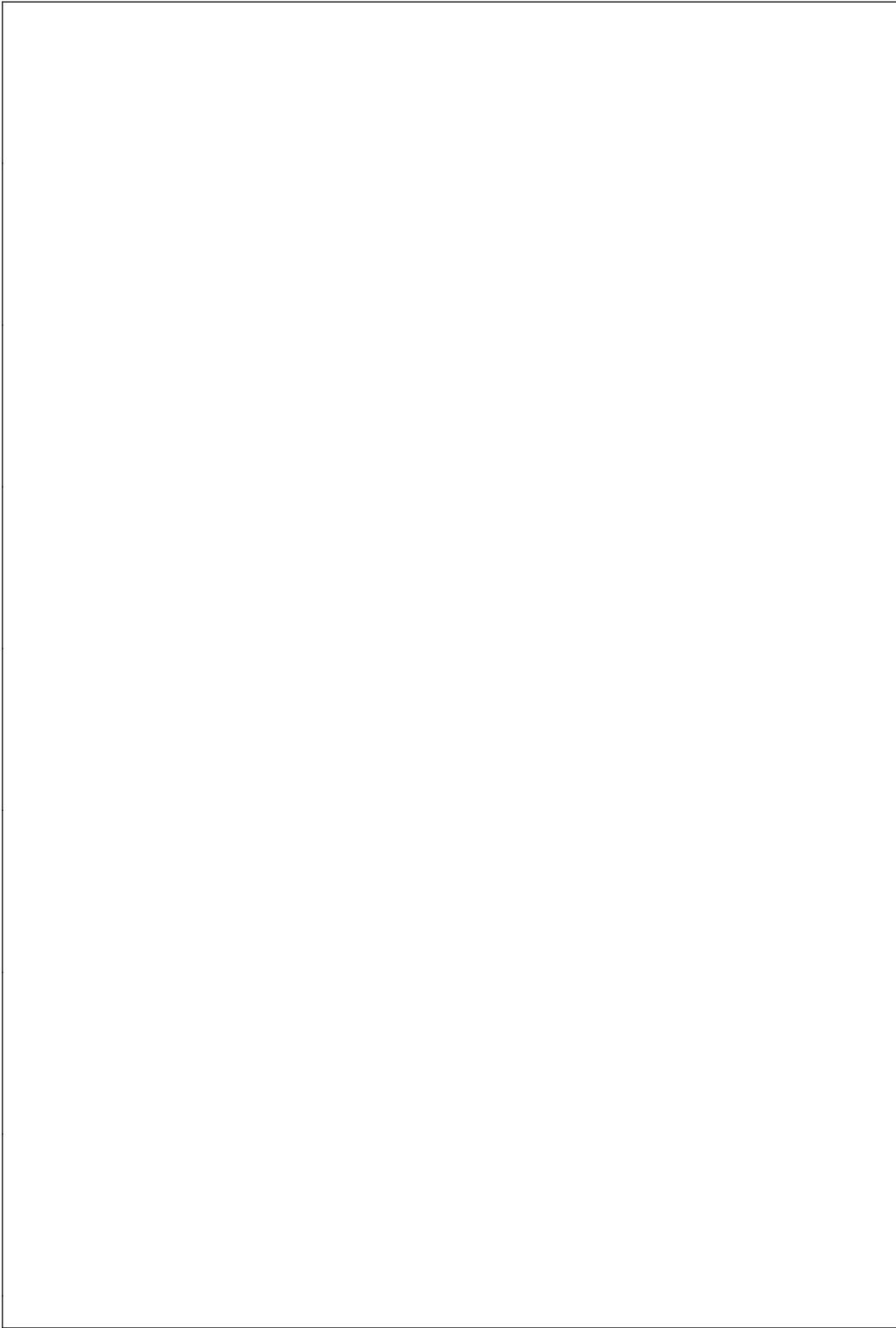

Physical Dimensions inches (millimeters)

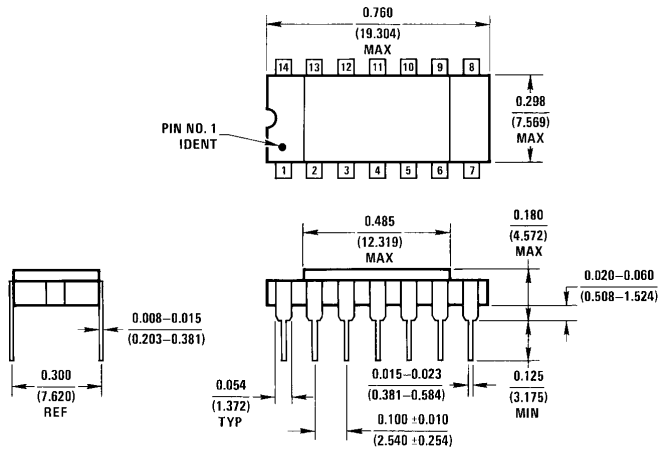

Order Number LF444AMD or LF444MD/883
See NS Package Number D14E

D14E (REV E)

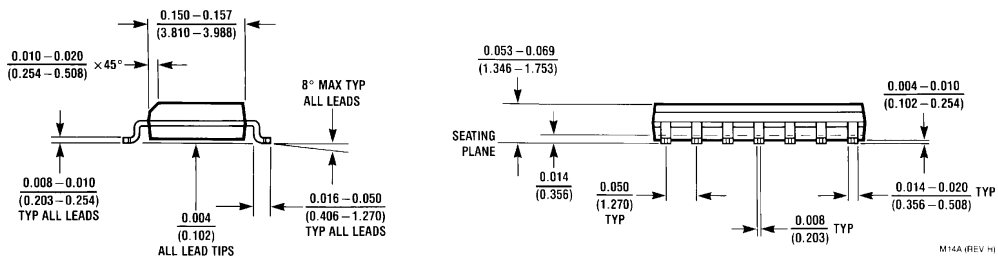
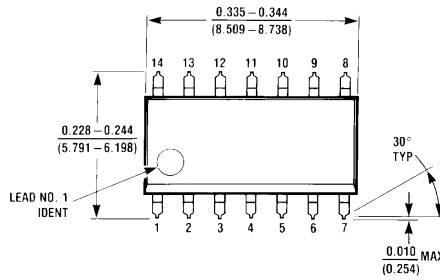

Order Number LF444CM
See NS Package Number M14A

M14A (REV H)

Physical Dimensions inches (millimeters) (Continued)

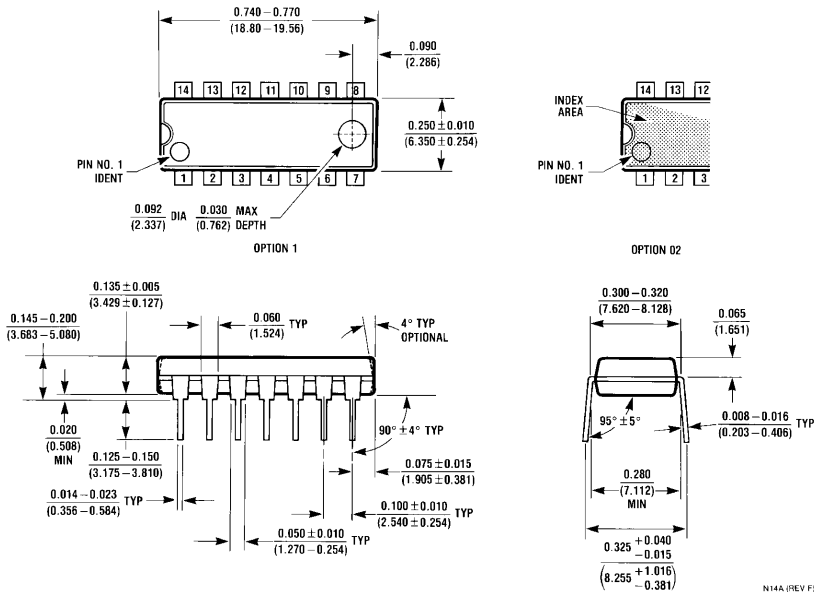

Order Number LF444ACN or LF444CN
See NS Package Number N14A

LIFE SUPPORT POLICY

NATIONAL'S PRODUCTS ARE NOT AUTHORIZED FOR USE AS CRITICAL COMPONENTS IN LIFE SUPPORT DEVICES OR SYSTEMS WITHOUT THE EXPRESS WRITTEN APPROVAL OF THE PRESIDENT OF NATIONAL SEMICONDUCTOR CORPORATION. As used herein:

1. Life support devices or systems are devices or systems which, (a) are intended for surgical implant into the body, or (b) support or sustain life, and whose failure to perform, when properly used in accordance with instructions for use provided in the labeling, can be reasonably expected to result in a significant injury to the user.
2. A critical component is any component of a life support device or system whose failure to perform can be reasonably expected to cause the failure of the life support device or system, or to affect its safety or effectiveness.



National Semiconductor Corporation
1111 West Bardin Road
Arlington, TX 76017
Tel: 1(800) 272-9959
Fax: 1(800) 737-7018

National Semiconductor Europe
Fax: (+49) 0-180-530 85 86
Email: cnjwge@tevm2.nsc.com
Deutsch Tel: (+49) 0-180-530 85 85
English Tel: (+49) 0-180-532 78 32
Français Tel: (+49) 0-180-532 93 58
Italiano Tel: (+49) 0-180-534 16 80

National Semiconductor Hong Kong Ltd.
19th Floor, Straight Block,
Ocean Centre, 5 Canton Rd.
Tsimshatsui, Kowloon
Hong Kong
Tel: (852) 2737-1600
Fax: (852) 2736-9960

National Semiconductor Japan Ltd.
Tel: 81-043-299-2309
Fax: 81-043-299-2408

National does not assume any responsibility for use of any circuitry described, no circuit patent licenses are implied and National reserves the right at any time without notice to change said circuitry and specifications.