



DS1991 MultiKey iButton™

SPECIAL FEATURES

- 1,152-bit secure read/write, nonvolatile memory
- Secure memory cannot be deciphered without matching 64-bit password
- Memory is partitioned into 3 blocks of 384 bits each
- 64-bit password and ID fields for each memory block
- 512-bit scratchpad ensures data transfer integrity
- Operating temperature range: -40°C to $+70^{\circ}\text{C}$
- Over 10 years of data retention

COMMON iButton FEATURES

- Unique, factory-lasered and tested 64-bit registration number (8-bit family code + 48-bit serial number + 8-bit CRC tester) assures absolute traceability because no two parts are alike
- Multidrop controller for MicroLAN™
- Digital identification and information by momentary contact
- Chip-based data carrier compactly stores information
- Data can be accessed while affixed to object
- Economically communicates to bus master with a single digital signal at 16.3k bits per second
- Standard 16 mm diameter and 1-Wire protocol ensure compatibility with iButton family
- Button shape is self-aligning with cup-shaped probes
- Durable stainless steel case engraved with registration number withstands harsh environments
- Easily affixed with self-stick adhesive backing, latched by its flange, or locked with a ring pressed onto its rim
- Presence detector acknowledges when reader first applies voltage
- Meets UL#913 (4th Edit.); Intrinsically Safe Apparatus, Approved under Entity Concept for use in Class I, Division 1, Group A, B, C and D Locations

F5 MICROCAN™

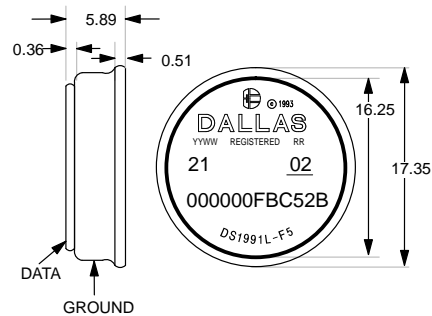

All dimensions shown in millimeters

ORDERING INFORMATION

DS1991L-F5 F5 MicroCan

EXAMPLES OF ACCESSORIES

DS9096P	Self-Stick Adhesive Pad
DS9101	Multi-Purpose Clip
DS9093RA	Mounting Lock Ring
DS9093F	Snap-In Fob
DS9092	iButton Probe

iButton DESCRIPTION

The DS1991 MultiKey iButton is a rugged read/write data carrier that acts as three separate electronic keys, offering 1,152 bits of secure, nonvolatile memory. Each key is 384 bits long with distinct 64-bit password and public ID fields (Figure 1). The password field must be matched in order to access the secure memory. Data is transferred serially via the 1-Wire protocol, which requires only a single data lead and a ground return. The 512-bit scratchpad serves to ensure integrity of data transfers to secure memory. Data should first be written to the scratchpad where it can be read back. After the data has been verified, a copy scratchpad command will transfer the data to the secure memory. This process insures data integrity when modifying the memory. A 48-bit serial number is factory lasered into each DS1991 to provide a guaranteed unique identity which allows for absolute traceability. The family code for the DS1991 is 02h. The durable MicroCan package is highly resistant to environmental hazards such as dirt, moisture and shock. Its compact button-shaped profile is self-aligning with mating receptacles, allowing the DS1991 to be easily used by human operators. Accessories permit the DS1991 to be mounted on plastic key fobs, photo-ID badges, printed-circuit boards or any smooth surface of an object. Applications include secure access control, debit tokens, work-in-progress tracking, electronic travelers and proprietary data.

OPERATION

The DS1991 is accessed via a single data line using the 1-Wire protocol. The bus master must first provide one of the four ROM Function Commands, 1) Read ROM, 2) Match ROM, 3) Search ROM, 4) Skip ROM. These commands operate on the 64-bit lasered ROM portion of each device and can singulate a specific device if many are present on the 1-Wire line as well as indicate to the bus master how many and what types of devices are present. The protocol required for these ROM Function Commands is described in Figure 9. After a ROM Function Command is successfully executed, the memory functions that operate on the secure memory and the scratchpad become accessible and the bus master may issue any one of the six Memory Function Commands specific to the DS1991. The protocol for these Memory Function Commands is described in Figure 5. All data is read and written least significant bit first.

64-BIT LASERED ROM

Each DS1991 contains a unique ROM code that is 64 bits long. The first eight bits are a 1-Wire family code. The next 48 bits are a unique serial number. The last eight bits are a CRC of the first 56 bits. (Figure 2.)

The 1-Wire CRC is generated using a polynomial generator consisting of a shift register and XOR gates as shown in Figure 3. The polynomial is $X^8 + X^5 + X^4 + 1$. Additional information about the Dallas 1-Wire Cyclic Redundancy Check is available in the Book of DS19xx iButton Standards.

The shift register bits are initialized to zero. Then starting with the least significant bit of the family code, one bit at a time is shifted in. After the 8th bit of the family code has been entered, then the serial number is entered. After the 48th bit of the serial number has been entered, the shift register contains the CRC value. Shifting in the eight bits of CRC should return the shift register to all zeros.

MEMORY FUNCTION COMMANDS

The DS1991 has six device-specific commands. Three scratchpad commands: Write Scratchpad, Read Scratchpad and Copy Scratchpad and three subkey commands: Write Password, Write Subkey and Read Subkey. After the device is selected, the memory function command is written to the DS1991. The command is comprised of three fields, each one byte long. The first byte is the function code field. This field defines the six commands that can be executed. The second byte is the address field. The first six bits of this field define the starting address of the command. The last two bits of this field are the subkey address code. The third byte of the command is a complement of the second byte (Figure 4).

For the first use, since the passwords actually stored in the device are unknown, the DS1991 needs to be initialized. This is done by directly writing (i. e., not through the scratchpad) the new identifier and password to the selected subkey using the Write Password command. As soon as the new identifier and password are stored in the device, further updates should be done through the scratchpad.

MEMORY MAP Figure 1

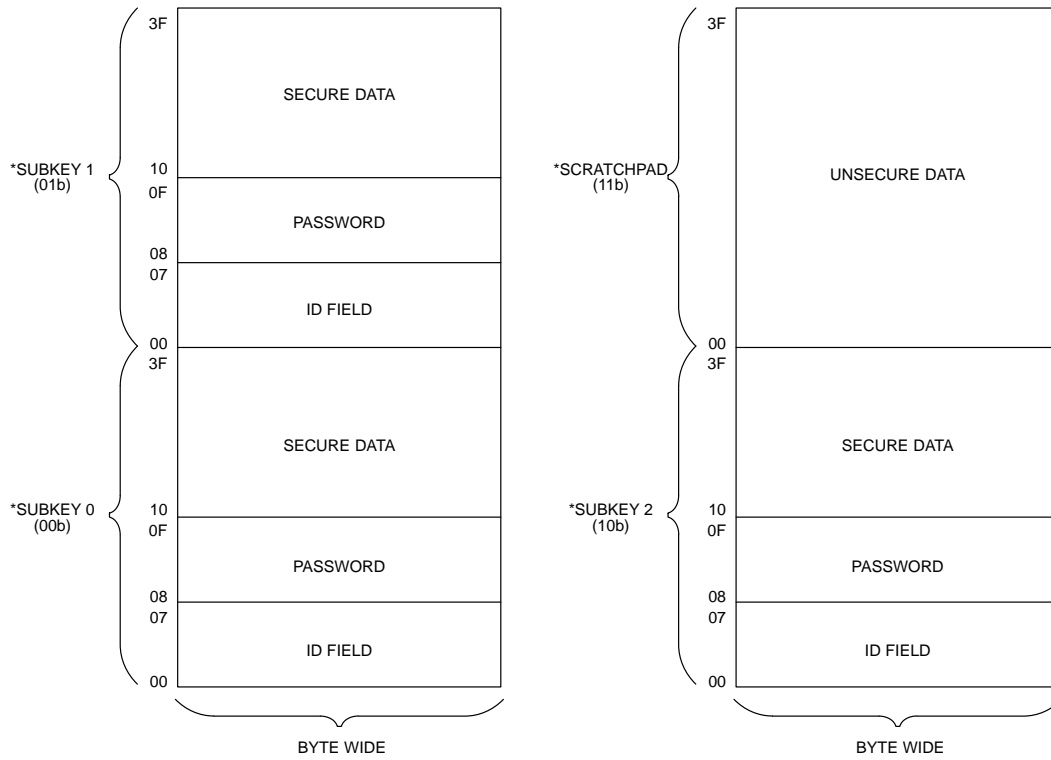

* Each subkey or the scratchpad has its own unique address.

64-BIT LASERED ROM Figure 2

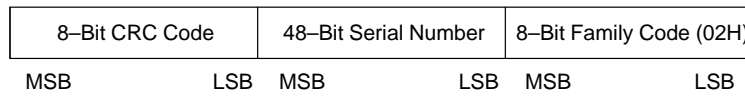

1-WIRE CRC GENERATOR Figure 3

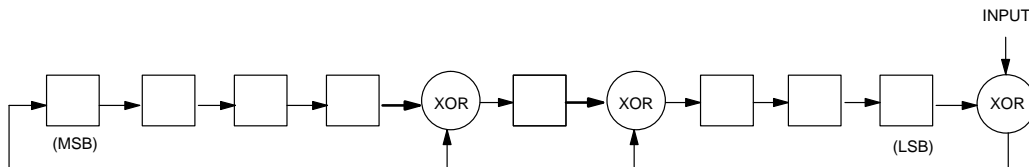

DS1991 COMMAND STRUCTURE Figure 4

Command	1st byte	2nd byte							3rd byte				
		B7	B6	B5	B4	B3	B2	B1		B0			
write scratchpad	96H	1	1	any value							ones complement of 2nd byte		
read scratchpad	69H			00H to 3FH									
copy scratchpad	3CH	Sub-Key Nr.:	0	0	0	0	0	0	0	0			
read SubKey	66H			any value									
write SubKey	99H			0	1	10H to 3FH							
write password	5AH			1	0	0	0	0	0	0		0	

SCRATCHPAD COMMANDS

The 64-byte read/write scratchpad of the DS1991 is not password-protected. Its normal use is to build up a data structure to be verified and then copied to a secure subkey.

Write Scratchpad [96H]

The Write Scratchpad command is used to enter data into the scratchpad. The starting address for the write sequence is specified in the command. Data can be continuously written until the end of the scratchpad is reached or until the DS1991 is reset. The command sequence is shown in Figure 5, first page, left column.

Read Scratchpad [69H]

The Read Scratchpad command is used to retrieve data from the scratchpad. The starting address is specified in the command word. Data can be continuously read until the end of the scratchpad is reached or until the DS1991 is reset. The command sequence is shown in Figure 5, first page, center column.

Copy Scratchpad [3CH]

The Copy Scratchpad command is used to transfer specified data blocks from the scratchpad to a selected subkey. This command should be used when data verification is required before storage in a secure subkey. Data can be transferred in single 8-byte blocks or in one large 64-byte block. There are nine valid block selector codes that are used to specify which block is to be trans-

ferred (Figure 6). As a further precaution against accidental erasure of secure data, the 8-byte password of the destination subkey must be entered. If the password does not match, the operation is terminated. After the block of data is transferred to the secure subkey, the original data in the corresponding block of the scratchpad is erased. The command sequence is shown in Figure 5, first page, right column.

SUBKEY COMMANDS

Each of the subkeys within the DS1991 is accessed individually. Transactions to read and write data to a secured subkey start at the address defined in the command and proceed until the device is reset or the end of the subkey is reached.

Write Password [5AH]

The Write Password command is used to enter the ID and password of the selected subkey. This command will erase all of the data stored in the secure area as well as overwriting the ID and password fields with the new data. The DS1991 has a built-in check to ensure that the proper subkey was selected. The sequence begins by reading the ID field of the selected subkey; the ID of the subkey to be changed is then written into the part. If the IDs do not match, the sequence is terminated. Otherwise, the subkey contents are erased and 64 bits of new ID data are written followed by a new 64-bit password. The command sequence is shown in Figure 5, 2nd page, right column.

MEMORY FUNCTIONS FLOW CHART Figure 5

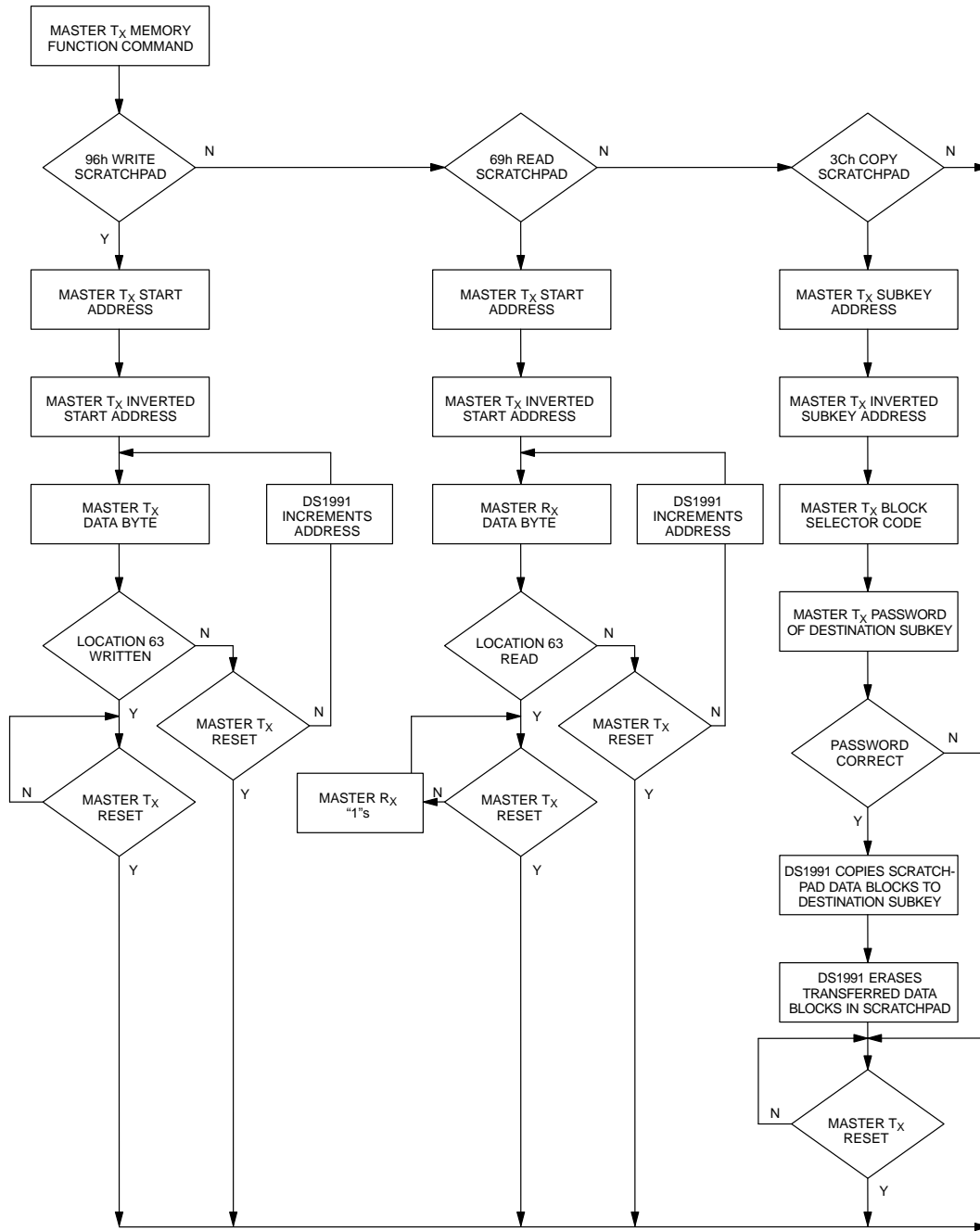

MEMORY FUNCTIONS FLOW CHART (cont'd) Figure 5

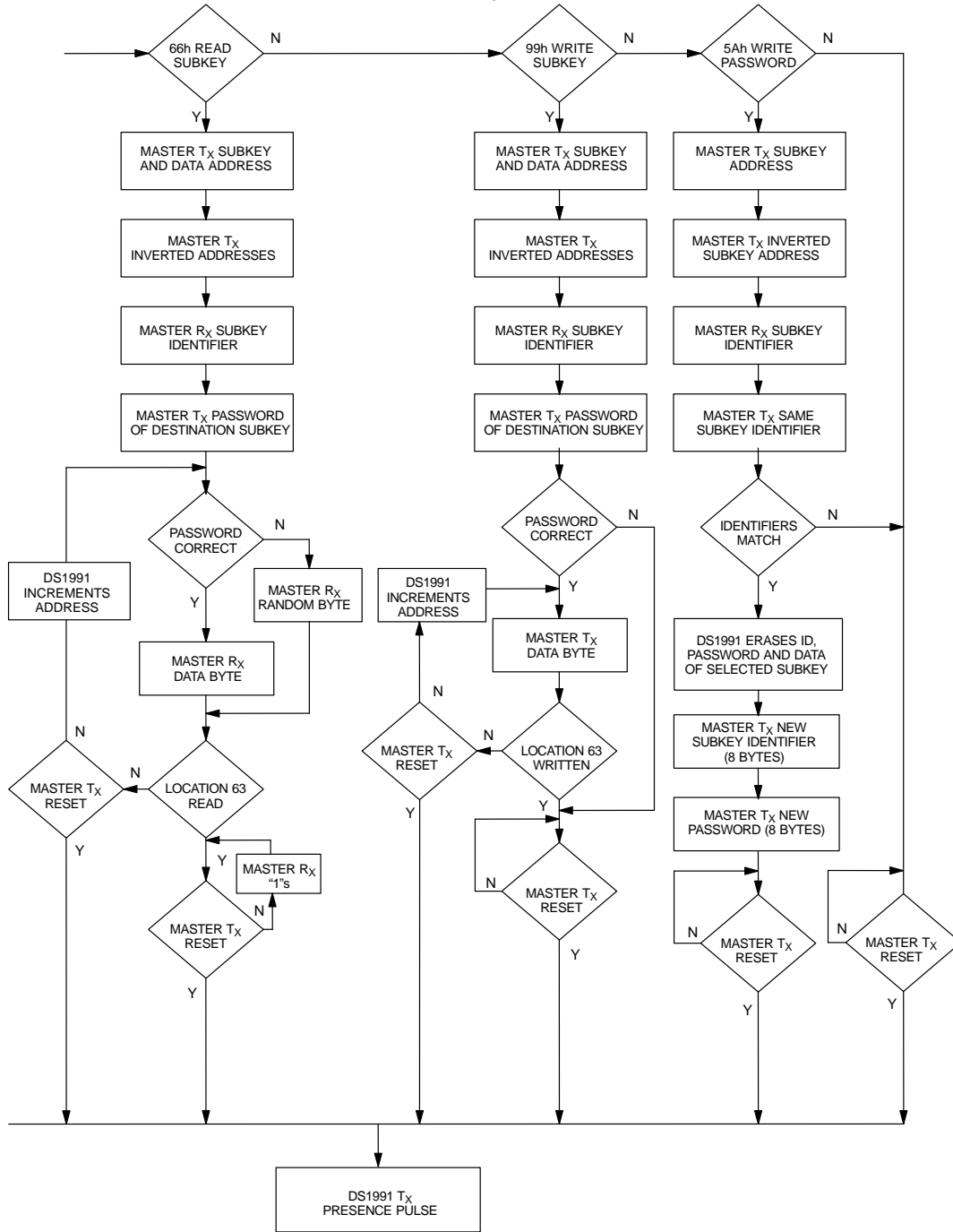

BLOCK SELECTOR CODES OF THE DS1991 Figure 6

Block Nr.	Address Range	LS Byte								MS Byte
		Codes								
0 to 7	00 to 3FH	56	56	7F	51	57	5D	5A	7F	
0	identifier	9A	9A	B3	9D	64	6E	69	4C	
1	password	9A	9A	4C	62	9B	91	69	4C	
2	10H to 17H	9A	65	B3	62	9B	6E	96	4C	
3	18H to 1FH	6A	6A	43	6D	6B	61	66	43	
4	20H to 27H	95	95	BC	92	94	9E	99	BC	
5	28H to 2FH	65	9A	4C	9D	64	91	69	B3	
6	30H to 37H	65	65	B3	9D	64	6E	96	B3	
7	38H to 3FH	65	65	4C	62	9B	91	96	B3	

Write SubKey [99H]

The Write Subkey command is used to enter data into the selected subkey. Since the subkeys are secure, the correct password is required to access them. The sequence begins by reading the ID field; the password is then written back. If the password is incorrect, the transaction is terminated. Otherwise, the data following is written into the secure area. The starting address for the write sequence is specified in the command word. Data can be continuously written until the end of the secure subkey is reached or until the DS1991 is reset. The command sequence is shown in Figure 5, 2nd page, center column.

Read SubKey [66H]

The Read Subkey command is used to retrieve data from the selected subkey. Since the subkeys are secure, the correct password is required to access them. The sequence begins by reading the ID field; the password is then written back. If the password is incorrect, the DS1991 will transmit random data. Otherwise the data can be read from the subkey. The starting address is specified in the command. Data can be continuously read until the end of the subkey is reached or until the DS1991 is reset. The command sequence is shown in Figure 5, 2nd page, left column.

1-WIRE BUS SYSTEM

The 1-Wire bus is a system which has a single bus master and one or more slaves. In all instances, the DS1991 is a slave device. The bus master is typically a microcontroller. The discussion of this bus system is broken down into three topics: hardware configuration, transaction

sequence, and 1-Wire signalling (signal types and timing). A 1-Wire protocol defines bus transactions in terms of the bus state during specified time slots that are initiated on the falling edge of sync pulses from the bus master. For a more detailed protocol description, refer to Chapter 4 of the Book of DS19xx iButton Standards.

HARDWARE CONFIGURATION

The 1-Wire bus has only a single line by definition; it is important that each device on the bus be able to drive it at the appropriate time. To facilitate this, each device attached to the 1-Wire bus must have an open drain connections or 3-state outputs. The DS1991 is an open drain part with an internal circuit equivalent to that shown in Figure 7. The bus master can be the same equivalent circuit. If a bidirectional pin is not available, separate output and input pins can be tied together.

The bus master requires a pull-up resistor at the master end of the bus, with the bus master circuit equivalent to the one shown in Figures 8a and 8b. The value of the pull-up resistor should be approximately 5 k Ω for short line lengths.

A multidrop bus consists of a 1-Wire bus with multiple slaves attached. The 1-Wire bus has a maximum data rate of 16.3k bits per second. The idle state for the 1-Wire bus is high. If, for any reason a transaction needs to be suspended, the bus MUST be left in the idle state if the transaction is to resume. If this does not occur, and the bus is left low for more than 120 μ s, one or more of the devices on the bus may be reset.

EQUIVALENT CIRCUIT Figure 7

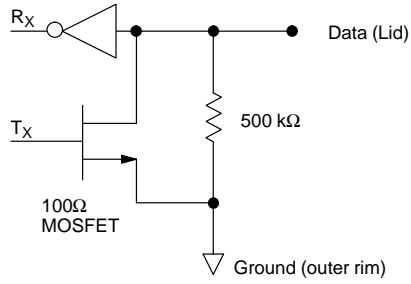

BUS MASTER CIRCUIT Figure 8

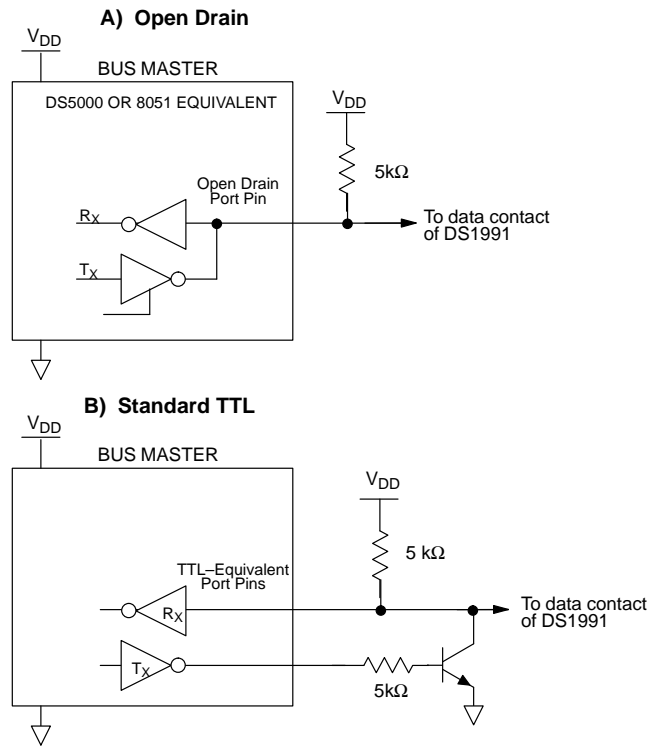

TRANSACTION SEQUENCE

The protocol for accessing the DS1991 via the 1-Wire port is as follows:

- Initialization
- ROM Function Command
- Memory Function Command
- Transaction/Data

INITIALIZATION

All transactions on the 1-Wire bus begin with an initialization sequence. The initialization sequence consists of a reset pulse transmitted by the bus master followed by presence pulse(s) transmitted by the slave(s).

The presence pulse lets the bus master know that the DS1991 is on the bus and is ready to operate. For more details, see the "1-Wire Signalling" section

ROM FUNCTION COMMANDS

Once the bus master has detected a presence pulse, it can issue one of the four ROM function commands. All ROM function commands are eight bits long. A list of these commands follows (refer to flowchart in Figure 9).

Read ROM [33H]

This command allows the bus master to read the DS1991's 8-bit family code, unique 48-bit serial number and 8-bit CRC. This command can be used only if there is a single DS1991 on the bus. If more than one slave is present on the bus, a data collision will occur when all slaves try to transmit at the same time (open drain will produce a wired-AND result).

Match ROM [55H]

The match ROM command, followed by a 64-bit ROM sequence, allows the bus master to address a specific DS1991 on a multidrop bus. Only the DS1991 that exactly matches the 64-bit ROM sequence will respond to the subsequent memory function command. All slaves that do not match the 64-bit ROM sequence will wait for a reset pulse. This command can be used with a single or multiple devices on the bus.

Skip ROM [CCH]

This command can save time in a single drop bus system by allowing the bus master to access the memory functions without providing the 64-bit ROM code. If more than one slave is present on the bus and a read command is issued following the Skip ROM command, data collision will occur on the bus as multiple slaves transmit simultaneously (open drain will produce a wired-AND result).

Search ROM [FOH]

When a system is initially brought up, the bus master might not know the number of devices on the 1-Wire bus or their 64-bit ROM codes. The Search ROM command allows the bus master to use a process of elimination to identify the 64-bit ROM codes of all slave devices on the bus. The ROM search process is the repetition of a simple 3-step routine: read a bit, read the complement of the bit, then write the desired value of that bit. The bus master performs this simple 3-step routine on each bit of the ROM. After one complete pass, the bus master knows the contents of the ROM in one device. The remaining number of devices and their ROM codes may be identified by additional passes. See Chapter 5 of the Book of DS19xx iButton Standards for a comprehensive discussion of a search ROM, including an actual example.

1-WIRE SIGNALLING

The DS1991 requires strict protocols to insure data integrity. The protocol consists of four types of signalling on one line: Reset Sequence with Reset Pulse and Presence Pulse, Write 0, Write 1 and Read Data. All these signals except presence pulse are initiated by the bus master. The initialization sequence required to begin any communication with the DS1991 is shown in Figure 10. A reset pulse followed by a presence pulse indicates the DS1991 is ready to send or receive data given the correct ROM command and memory function command. The bus master transmits (TX) a reset pulse (t_{RSTL} , minimum 480 μ s). The bus master then releases the line and goes into receive mode (RX). The 1-Wire bus is pulled to a high state via the pull-up resistor. After detecting the rising edge on the data pin, the DS1991 waits (t_{PDH} , 15–60 μ s) and then transmits the presence pulse (t_{PDL} , 60–240 μ s).

ROM FUNCTIONS FLOW CHART Figure 9

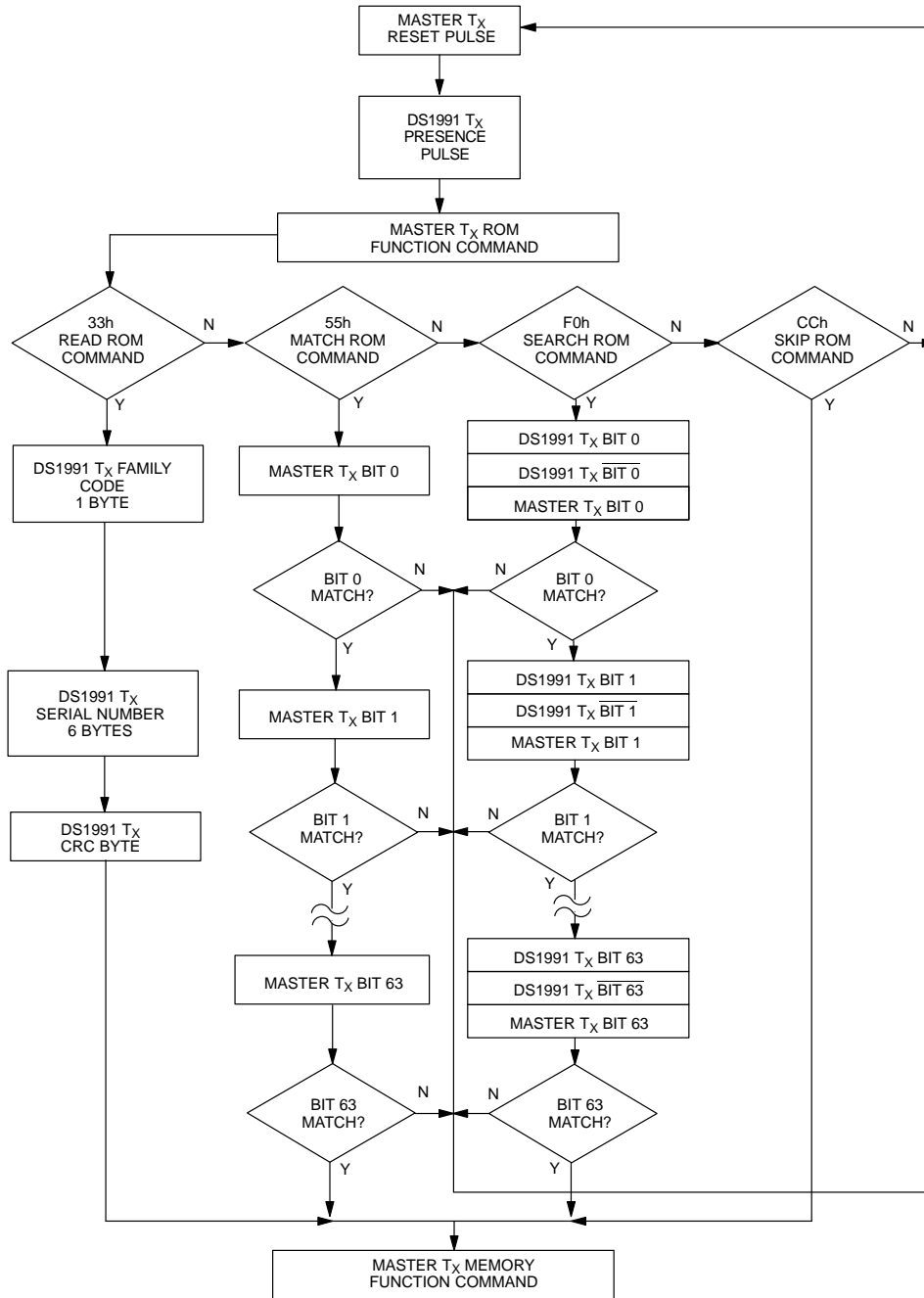

INITIALIZATION PROCEDURE “RESET AND PRESENCE PULSES” Figure 10

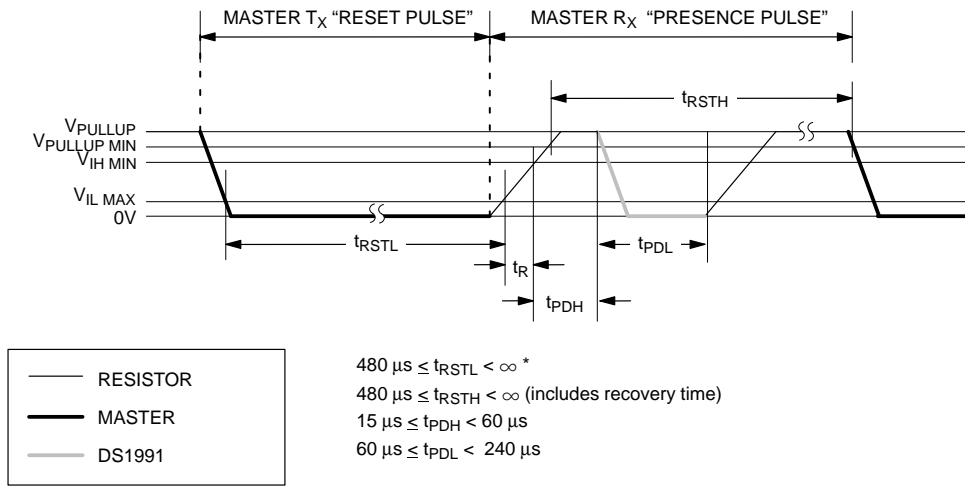

* In order not to mask interrupt signalling by other devices on the 1-Wire bus, $t_{RSTL} + t_R$ should always be less than 960 μs .

READ/WRITE TIME SLOTS

The definitions of write and read time slots are illustrated in Figure 11. All time slots are initiated by the master driving the data line low. The falling edge of the data line synchronizes the DS1991 to the master by triggering a delay circuit in the DS1991. During write time slots, the

delay circuit determines when the DS1991 will sample the data line. For a read data time slot, if a “0” is to be transmitted, the delay circuit determines how long the DS1991 will hold the data line low overriding the 1 generated by the master. If the data bit is a “1”, the \bar{i} Button will leave the read data time slot unchanged.

READ/WRITE TIMING DIAGRAM Figure 11

Write-One Time Slot

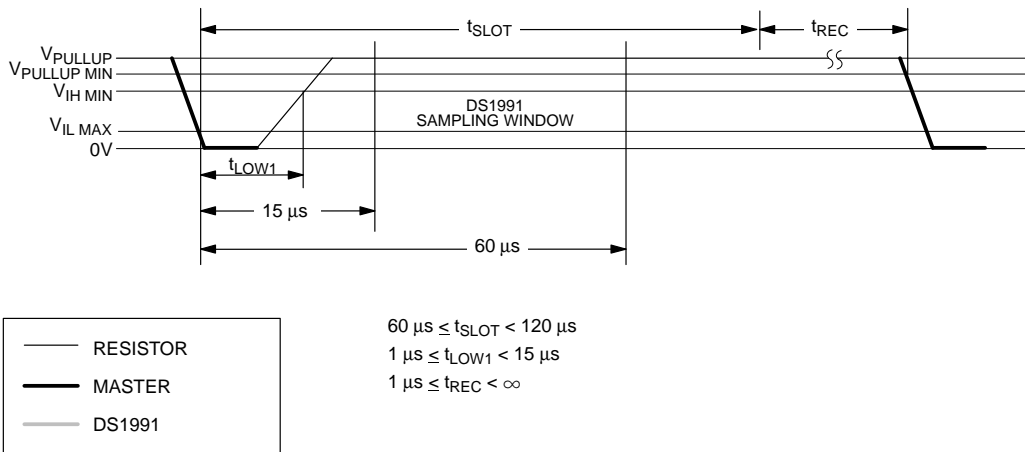

READ/WRITE TIMING DIAGRAM (cont'd) Figure 11

Write-Zero Time Slot

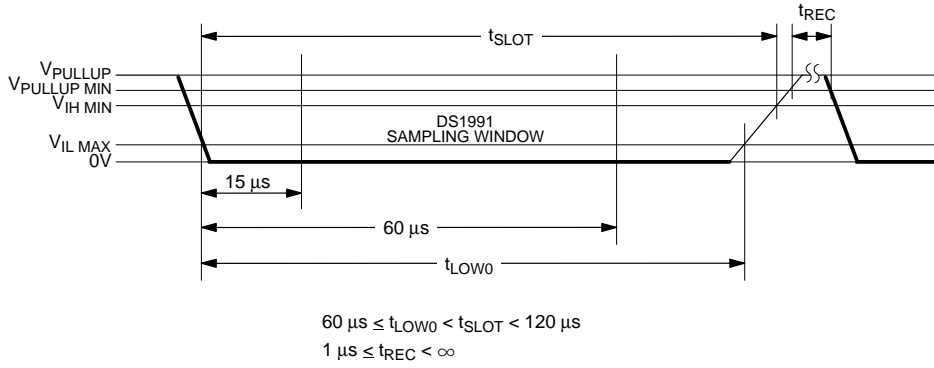

Read-Data Time Slot

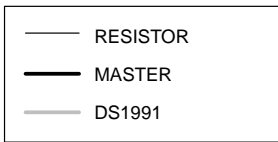
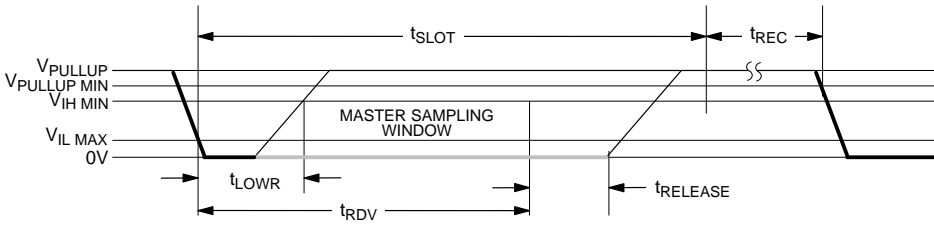

$60\ \mu s \leq t_{SLOT} < 120\ \mu s$
 $1\ \mu s \leq t_{LOWR} < 15\ \mu s$
 $0 \leq t_{RELEASE} < 45\ \mu s$
 $1\ \mu s \leq t_{REC} < \infty$
 $t_{RDV} = 15\ \mu s$

PHYSICAL SPECIFICATIONS

Size	See mechanical drawing
Weight	3.3 grams (F5 package)
Humidity	90% RH at 50°C
Altitude	10,000 feet
Expected Service Life	10 years at 25°C (150 million transactions, see note 4)
Safety	Meets UL#913 (4th Edit.); Intrinsically Safe Apparatus, Approved under Entity Concept for use in Class I, Division 1, Group A, B, C and D Locations

ABSOLUTE MAXIMUM RATINGS*

Voltage on any Pin Relative to Ground	-0.5V to +7.0V
Operating Temperature	-40°C to +70°C
Storage Temperature	-40°C to +70°C

* This is a stress rating only and functional operation of the device at these or any other conditions above those indicated in the operation sections of this specification is not implied. Exposure to absolute maximum rating conditions for extended periods of time may affect reliability.

DC ELECTRICAL CHARACTERISTICS(V_{PUP}*=2.8V to 6.0V; -40°C to +70°C)

PARAMETER	SYMBOL	MIN	TYP	MAX	UNITS	NOTES
Input Logic Low	V _{IL}	-0.3		0.8	V	1
Input Logic High	V _{IH}	2.2		6.0	V	
Output Logic Low @ 4 mA	V _{OL}			0.4	V	
Output Logic High	V _{OH}		V _{PUP}	6.0	V	1, 2
Input Resistance	R _I		500		kΩ	3

* V_{PUP} = external pull-up voltage

AC ELECTRICAL CHARACTERISTICS

(-40°C to 70°C)

PARAMETER	SYMBOL	MIN	TYP	MAX	UNITS	NOTES
Time Slot Period	t _{SLOT}	60		120	μs	
Write 1 Low Time	t _{LOW1}	1		15	μs	
Write 0 Low Time	t _{LOW0}	60		120	μs	
Read Data Valid	t _{RDV}	exactly 15			μs	
Release Time	t _{RELEASE}	0	15	45	μs	
Read Data Setup	t _{SU}			1	μs	5
Recovery Time	t _{REC}	1			μs	
Reset Low Time	t _{RSTL}	480			μs	
Reset High Time	t _{RSTH}	480			μs	4
Presence Detect High	t _{PDH}	15		60	μs	
Presence Detect Low	t _{PDL}	60		240	μs	

NOTES:

1. All voltages are referenced to ground.
2. V_{PUP} = external pull-up voltage to system supply.
3. Input pulldown resistance to ground.
4. An additional reset or communication sequence cannot begin until the reset high time has expired.
5. Read data setup time refers to the time the host must pull the 1-Wire bus low to read a bit. Data is guaranteed to be valid within 1 μ s of this falling edge and will remain valid for 14 μ s minimum. (15 μ s total from falling edge on 1-Wire bus.)

