

ASSP Mobile Communication Systems

Piezoelectric SAW BPF (700 to 1700 MHz)

F5/F6 Series (K2 type)

■ DESCRIPTION

The F5CE/F6CE-K2 series of SAW band pass filters is available in the 700-1700 MHz frequency range and exhibit high stability by using single crystal Lithium Tantalate (LiTaO_3) with a large electro-mechanical coefficient. The F5CE/F6CE-K2 series provides low insertion loss and wide pass-band width by taking advantage of FUJITSU MEDIA DEVICE'S unique "Ladder-type" design.

Typical applications for the F5CE/F6CE-K2 series include RF interstage filter in mobile communications systems. Standard devices are available for AMPS/TDMA/CDMA, GSM, EGSM, PDC800, J-CDMA, PDC1.5G and so on. If higher attenuation is preferred, our F5CE-D2 series is also recommended.

■ FEATURES

- Low insertion loss and good skirt performance
- Compact and light package (3.0 mm sq.)
- External matching circuits are not required. (50 Ω I/O)
- Surface mount package (SMT)
- Standard devices are available for mobile communication standards.

■ PACKAGE

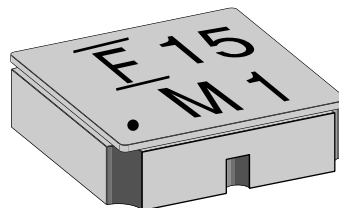

F5/F6 Series (K2 type)

■ PIN ASSIGNMENT

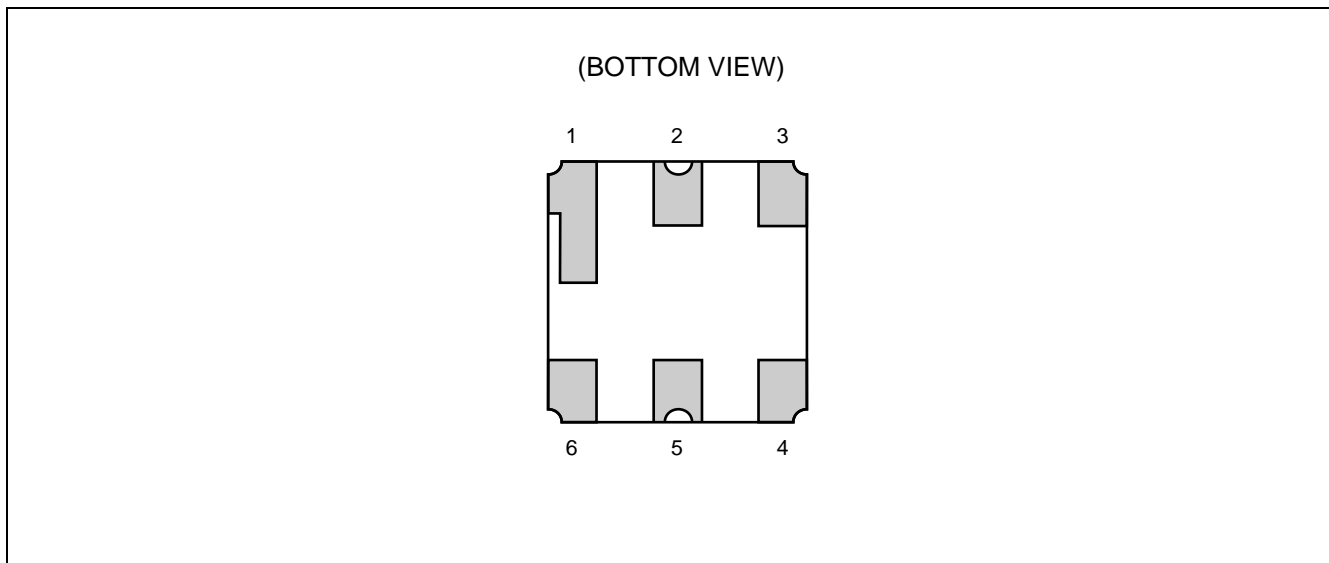

■ PIN DESCRIPTION

Pin No.	Pin name	Description
1	GND	Ground Pin
2	IN	Input Pin
3	GND	Ground Pin
4	GND	Ground Pin
5	OUT	Output Pin
6	GND	Ground Pin

■ ABSOLUTE MAXIMUM RATINGS

Parameter	Symbol	Rating		Unit
		Min.	Max.	
Operating temperature	Ta	-30	+85	°C
Storage temperature	Tstg	-40	+100	°C
Input level	P _{IN}	—	+23	dBm
Input DC voltage	—	-5	+5	V

WARNING: Piezoelectric devices can be permanently damaged by application of stress (voltage, current, temperature, etc.) in excess of absolute maximum ratings. Do not exceed these ratings.

F5/F6 Series (K2 type)

RECOMMENDED OPERATING CONDITIONS

Parameter	Symbol	Value		Unit
		Min.	Max.	
Operating temperature	Ta	-30	+85	°C

WARNING: The recommended operating conditions are required in order to ensure the normal operation of the piezoelectric device. All of the device's electrical characteristics are warranted when the device is operated within this range.

Always use piezoelectric devices within their recommended operating condition ranges. Operation outside these ranges may adversely affect reliability and could result in device failure.

No warranty is made with respect to uses, operating conditions, or combinations not represented on the data sheet. Users considering application outside the listed conditions are advised to contact their FUJITSU representatives beforehand.

STANDARD DEVICES

System		Center frequency (MHz)	Band width (MHz)	Part symbol	Part number	Remarks
AMPS/TDMA/CDMA	Tx	836.5	25	25	FAR-F5CE-836M50-K225	Low loss type
		836.5	25	36	FAR-F5CE-836M50-K236	Low loss type
		836.5	25	30	FAR-F5CE-836M50-K230	High Att. type
		836.5	25	89	FAR-F5CE-836M50-K289	High Att. type
	Rx	881.5	25	35	FAR-F5CE-881M50-K235	Low loss type
GSM	Tx	902.5	25	13	FAR-F5CE-902M50-K213	
	Rx	947.5	25	33	FAR-F5CE-947M50-K233	Ultra low loss
		947.5	25	14	FAR-F5CE-947M50-K214	Low loss type
EGSM	Tx	897.5	35	26	FAR-F5CE-897M50-K226	
		897.5	35	31	FAR-F5CE-897M50-K231	Low loss type
	Rx	942.5	35	88	FAR-F5CE-942M50-K288	Low loss type
		942.5	35	37	FAR-F5CE-942M50-K237	
PDC800 (20 MHz pass-band width standard)	Tx	950.0	20	01	FAR-F5CE-950M00-K201	
	Rx	820.0	20	02	FAR-F5CE-820M00-K202	Low loss type
		820.0	20	04	FAR-F5CE-820M00-K204	High Att. type
J-CDMA	Tx	906.0	38	19	FAR-F5CE-906M00-K219	
		906.0	38	15	FAR-F5CE-906M00-K215	High Att. type
		906.0	38	38	FAR-F5CE-906M00-K238	
	Rx	851.0	38	12	FAR-F5CE-851M00-K212	
PDC1.5 G	Tx	1441.0	24	20	FAR-F6CE1G4410-K220	
	Rx	1489.0	24	21	FAR-F6CE1G4890-K221	
	Lo	1619.0	24	22	FAR-F6CE1G6190-K222	

F5/F6 Series (K2 type)

ELECTRICAL CHARACTERISTICS AND TYPICAL FREQUENCY RESPONSE

1. AMPS/TDMA/CDMA (Tx) Low Loss type Part number : FAR-F5CE-836M50-K225

(Ta = -30 °C to +85 °C)

Parameter	Conditions	Value			Unit	Remarks
		Min.	Typ.	Max.		
Insertion loss	824 MHz to 849 MHz	—	2.0	2.5	dB	
Pass-band ripple	824 MHz to 849 MHz	—	0.9	1.5	dB	
Absolute stop-band attenuation	DC to 800 MHz	20	23	—	dB	
	869 MHz to 894 MHz	28	30	—	dB	
	894 MHz to 2000 MHz	22	25	—	dB	
Pass-band VSWR (Return loss)	824 MHz to 849 MHz	— (6.2)	2.6 (7.0)	2.9 (—)	— (dB)	

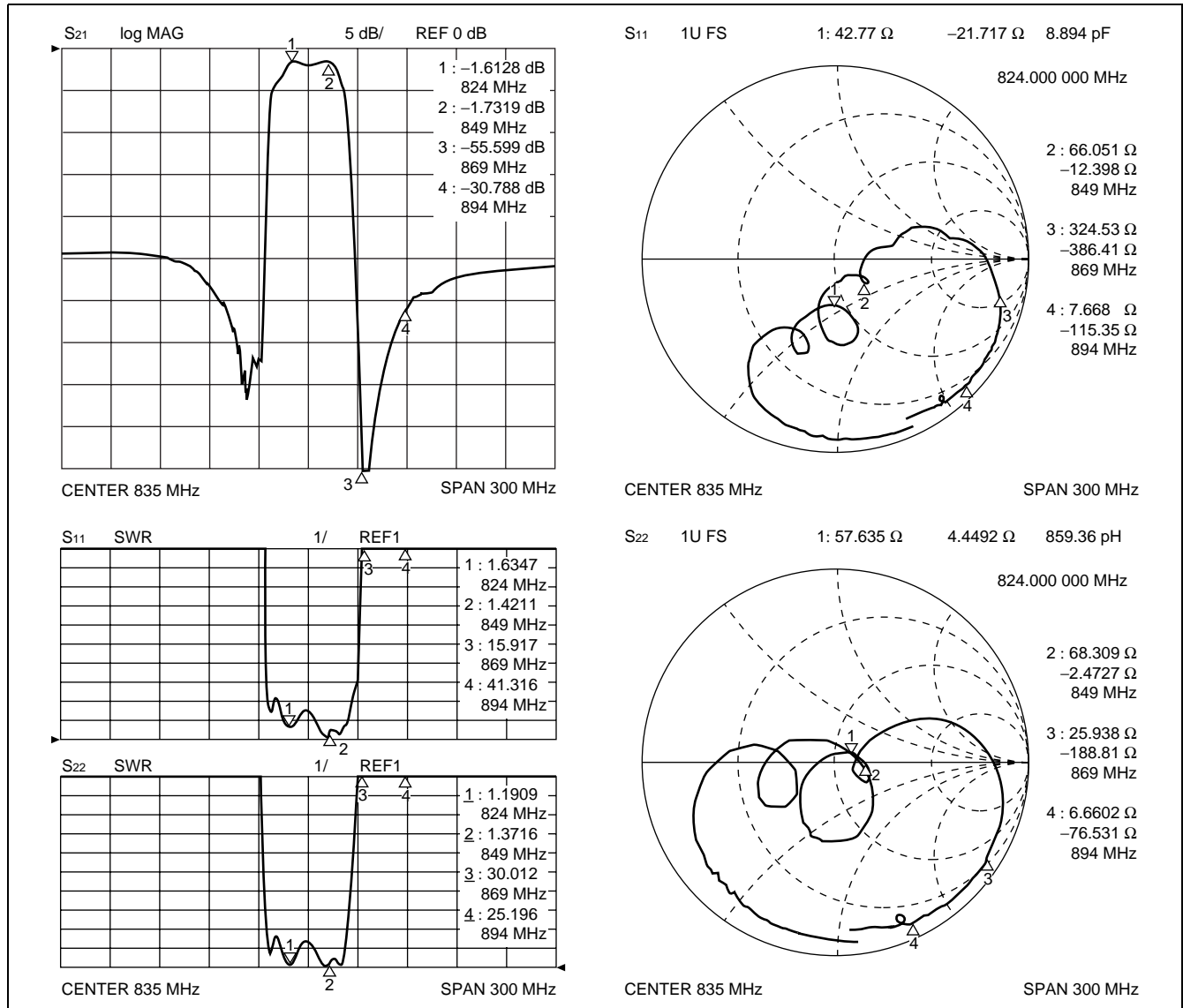

F5/F6 Series (K2 type)

2. AMPS/TDMA/CDMA (Tx) Low Loss type Part number : FAR-F5CE-836M50-K236

(Ta = -30 °C to +85 °C)

Parameter	Conditions	Value			Unit	Remarks
		Min.	Typ.	Max.		
Insertion loss	824 MHz to 849 MHz	—	2.2	3.0	dB	
Pass-band ripple	824 MHz to 849 MHz	—	0.9	1.7	dB	
Absolute stop-band attenuation	DC to 800 MHz	25	26	2.2	dB	
	869 MHz to 894 MHz	30	35	—	dB	
	894 MHz to 1050 MHz	25	27	—	dB	
	1050 MHz to 1210 MHz	25	28	—	dB	
Pass-band VSWR (Return loss)	824 MHz to 849 MHz	—	1.8	2.2	—	
		(8.5)	(10.9)	(—)	(dB)	

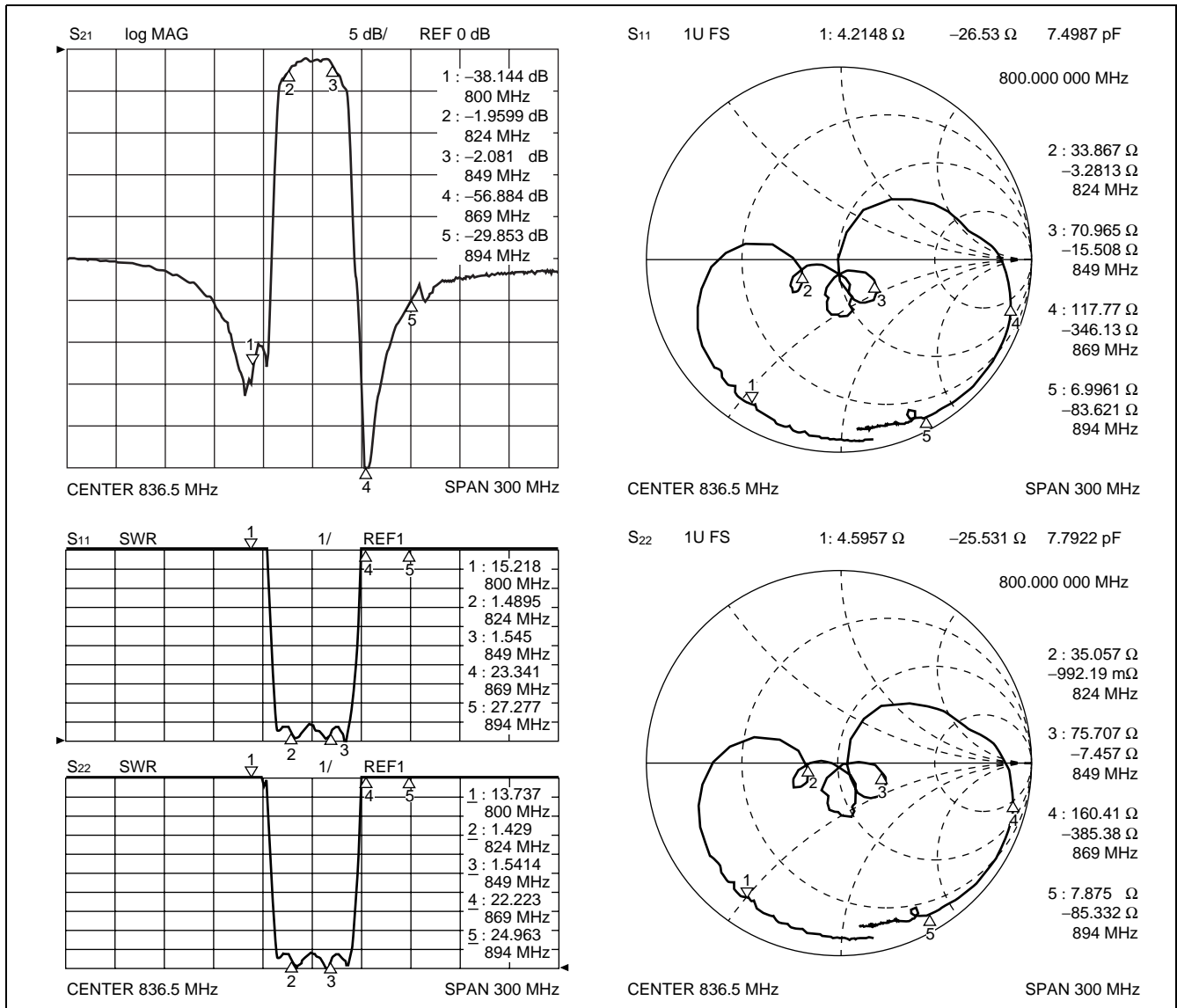

F5/F6 Series (K2 type)

3. AMPS/TDMA/CDMA (Tx) High Attenuation type Part number : FAR-F5CE-836M50-K230

(Ta = -30 °C to +85 °C)

Parameter	Conditions	Value			Unit	Remarks
		Min.	Typ.	Max.		
Insertion loss	824 MHz to 849 MHz	—	2.7	3.5	dB	
Pass-band ripple	824 MHz to 849 MHz	—	1.0	2.0	dB	
Absolute stop-band attenuation	DC to 800 MHz	28	30	—	dB	
	869 MHz to 894 MHz	30	43	—	dB	
	894 MHz to 1200 MHz	35	37	—	dB	
	1200 MHz to 2000 MHz	20	25	—	dB	
Pass-band VSWR (Return loss)	824 MHz to 849 MHz	— (8.5)	1.7 (11.7)	2.2 (—)	— (dB)	

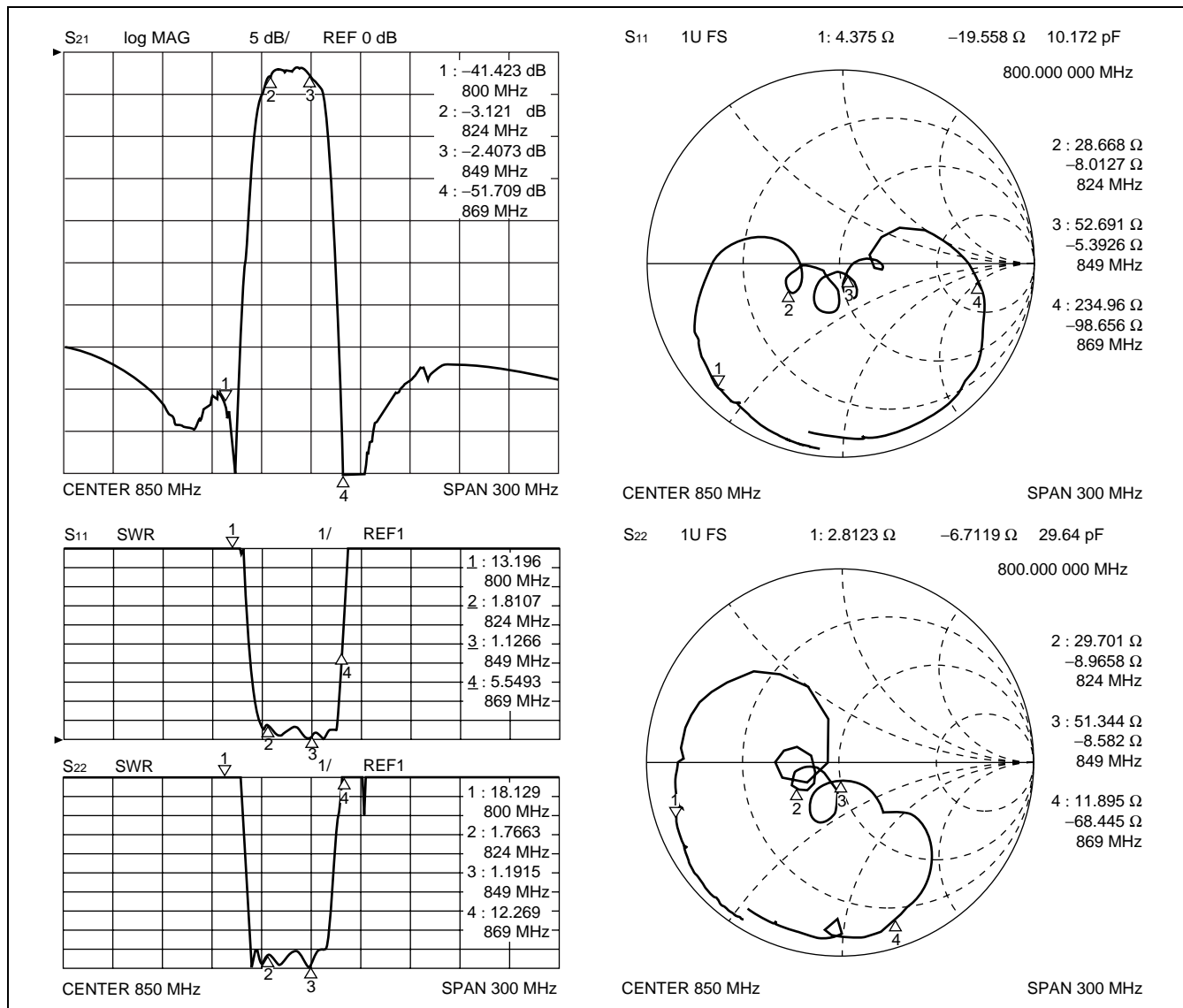

F5/F6 Series (K2 type)

4. AMPS/TDMA/CDMA (Tx) High Attenuation type Part number : FAR-F5CE-836M500-K289

(Ta = -30 °C to +85 °C)

Parameter	Conditions	Value			Unit	Remarks
		Min.	Typ.	Max.		
Insertion loss	824 MHz to 849 MHz	—	2.8	3.5	dB	
Pass-band ripple	824 MHz to 849 MHz	—	1.0	2.0	dB	
Absolute stop-band attenuation	DC to 800 MHz	30	32	—	dB	
	869 MHz to 894 MHz	40	45	—	dB	
	894 MHz to 1050 MHz	38	43	—	dB	
	1050 MHz to 1210 MHz	35	37	—	dB	
Pass-band VSWR (Return loss)	824 MHz to 849 MHz	— (9.5)	1.8 (10.9)	2.0 (—)	— (dB)	

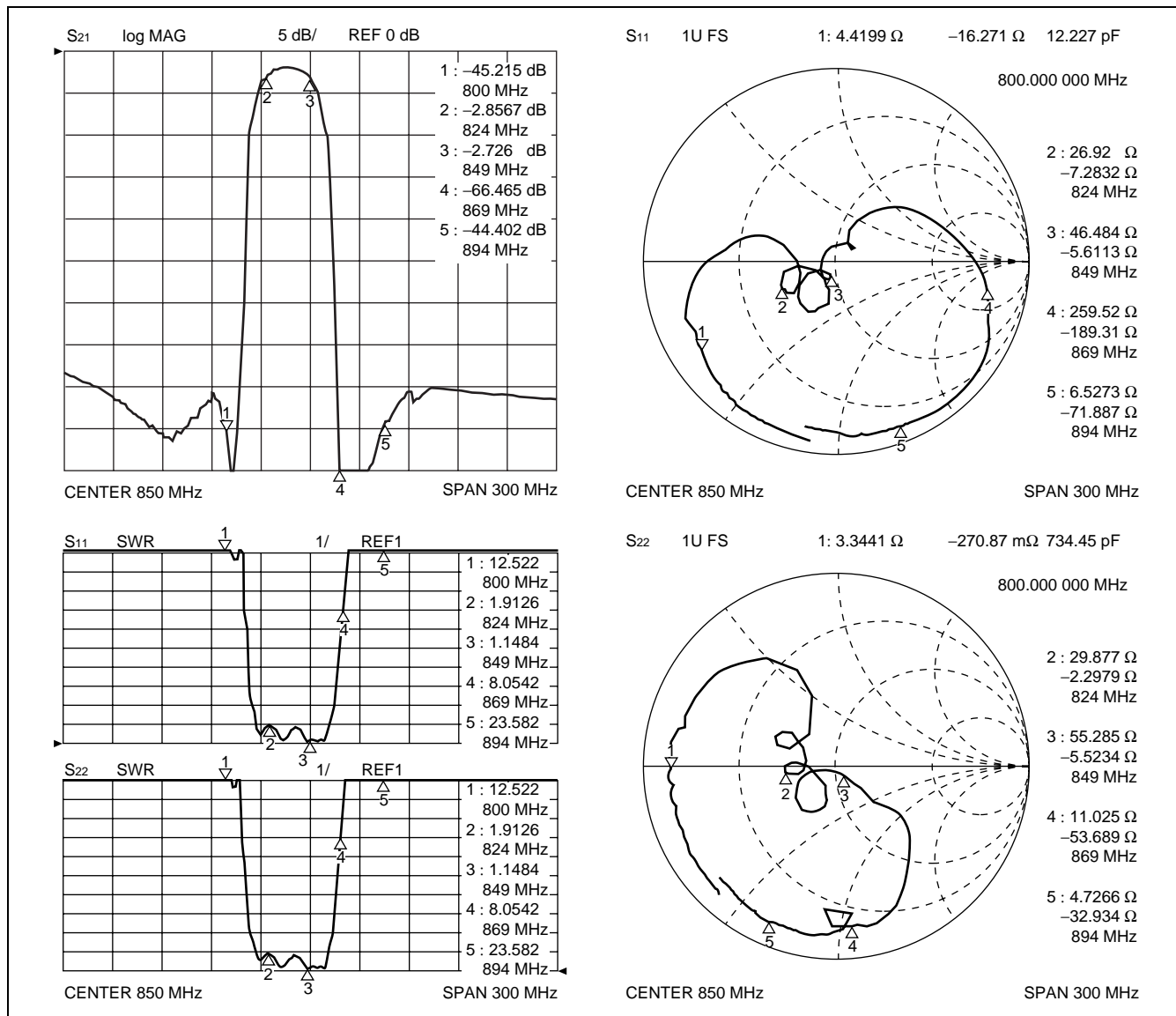

F5/F6 Series (K2 type)

5. AMPS/TDMA/CDMA (Rx) Low Loss type Part number : FAR-F5CE-881M50-K235

(Ta = -30 °C to +85 °C)

Parameter	Conditions	Value			Unit	Remarks
		Min.	Typ.	Max.		
Insertion loss	869 MHz to 894 MHz	—	2.0	3.0	dB	
Pass-band ripple	869 MHz to 894 MHz	—	0.8	1.8	dB	
Absolute stop-band attenuation	DC to 800 MHz	20	24	—	dB	
	824 MHz to 849 MHz	35	40	—	dB	
	939 MHz to 1049 MHz	28	31	—	dB	
	1049 MHz to 1200 MHz	28	32	—	dB	
Pass-band VSWR (Return loss)	869 MHz to 894 MHz	— (9.5)	1.7 (11.7)	2.0 (—)	— (dB)	

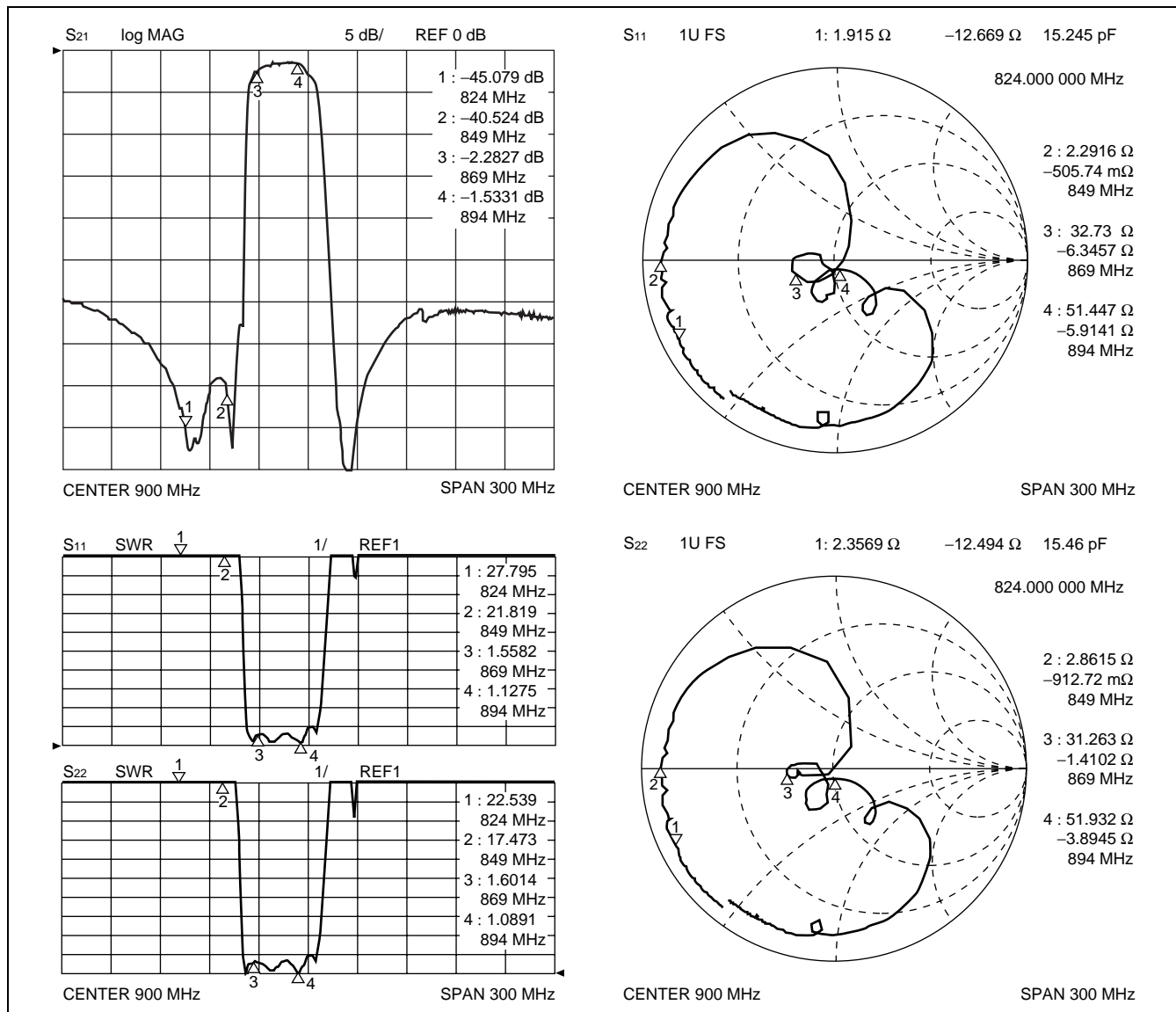

F5/F6 Series (K2 type)

6. GSM (Tx)

Part number : FAR-F5CE-902M50-K213

(Ta = -30 °C to +85 °C)

Parameter	Conditions	Value			Unit	Remarks
		Min.	Typ.	Max.		
Insertion loss	890 MHz to 915 MHz	—	3.0	3.5	dB	
Pass-band ripple	890 MHz to 915 MHz	—	1.0	2.0	dB	
Absolute stop-band attenuation	DC to 845 MHz	30	32	—	dB	
	845 MHz to 870 MHz	20	35	—	dB	
	935 MHz to 980 MHz	20	35	—	dB	
	980 MHz to 1200 MHz	35	37	—	dB	
Pass-band VSWR (Return loss)	890 MHz to 915 MHz	— (7.4)	2.0 (9.5)	2.5 (—)	— (dB)	

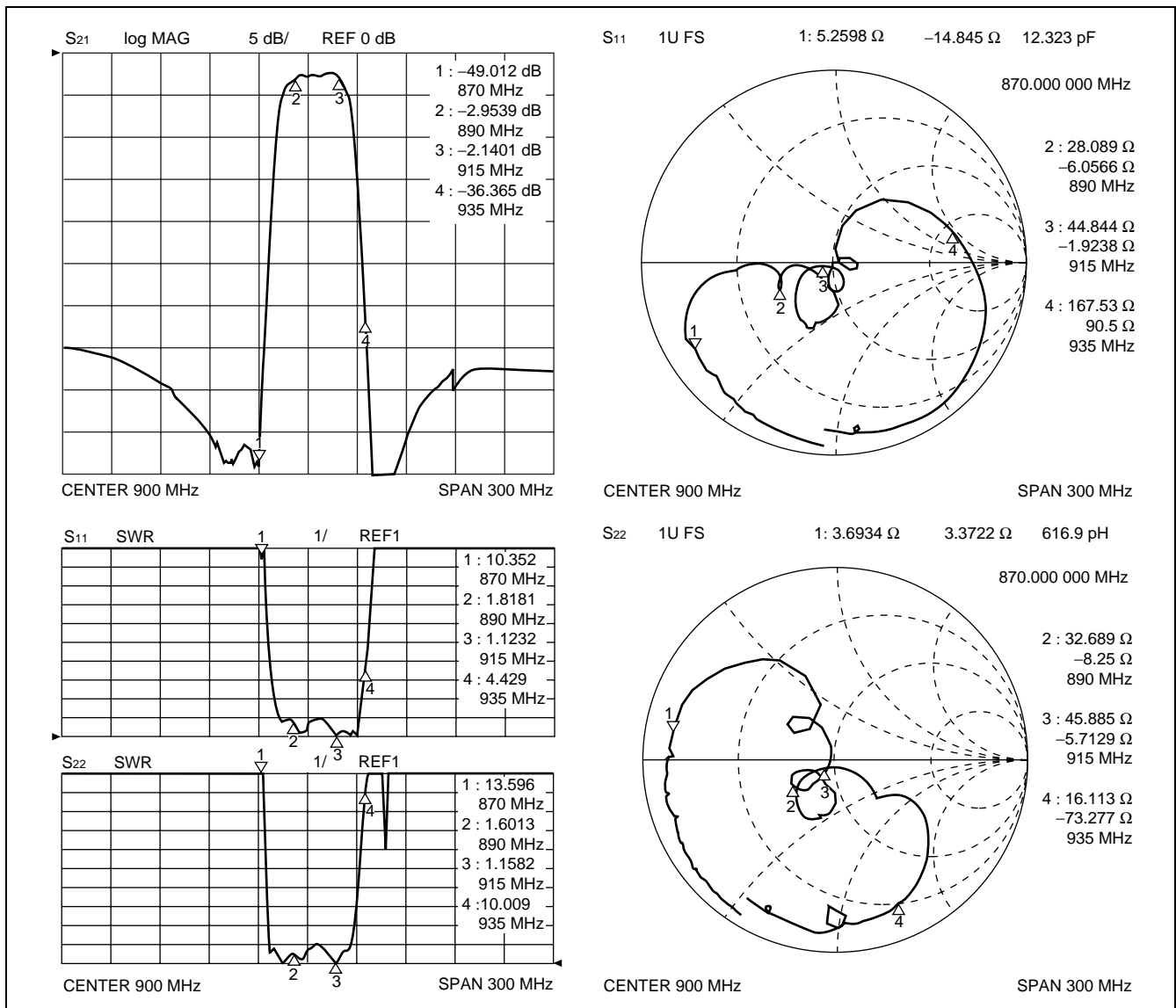

F5/F6 Series (K2 type)

7. GSM (Rx) Ultra Low Loss type Part number : FAR-F5CE-947M50-K233

(Ta = -30 °C to +85 °C)

Parameter	Conditions	Value			Unit	Remarks
		Min.	Typ.	Max.		
Insertion loss	935 MHz to 960 MHz	—	1.7	2.0	dB	
Pass-band ripple	935 MHz to 960 MHz	—	0.5	1.0	dB	
Absolute stop-band attenuation	DC to 905 MHz	17	19	—	dB	
	905 MHz to 915 MHz	15	25	—	dB	
	980 MHz to 1000 MHz	10	20	—	dB	
	1000 MHz to 1500 MHz	18	21	—	dB	
Pass-band VSWR (Return loss)	935 MHz to 960 MHz	— (7.4)	2.0 (9.5)	2.5 (—)	— (dB)	

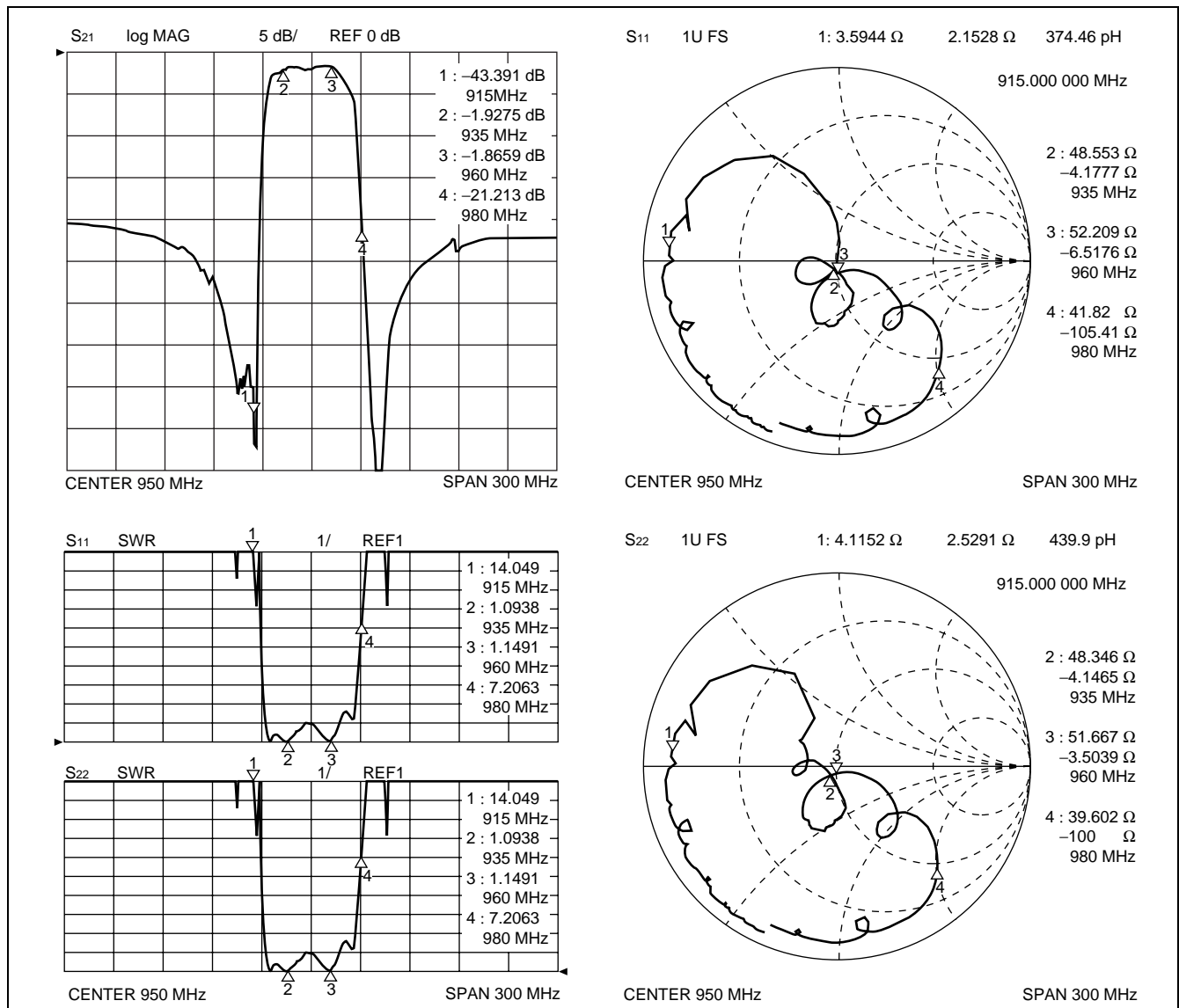

F5/F6 Series (K2 type)

8. GSM (Rx) Low Loss type

Part number : FAR-F5CE-947M50-K214

(Ta = -30 °C to +85 °C)

Parameter	Conditions	Value			Unit	Remarks
		Min.	Typ.	Max.		
Insertion loss	935 MHz to 960 MHz	—	2.7	3.0	dB	
Pass-band ripple	935 MHz to 960 MHz	—	1.0	1.5	dB	
Absolute stop-band attenuation	DC to 800 MHz	20	25	—	dB	
	890 MHz to 915 MHz	20	35	—	dB	
	980 MHz to 1025 MHz	20	25	—	dB	
	1025 MHz to 1600 MHz	27	32	—	dB	
Pass-band VSWR (Return loss)	935 MHz to 960 MHz	— (7.4)	2.0 (9.5)	2.5 (—)	— (dB)	

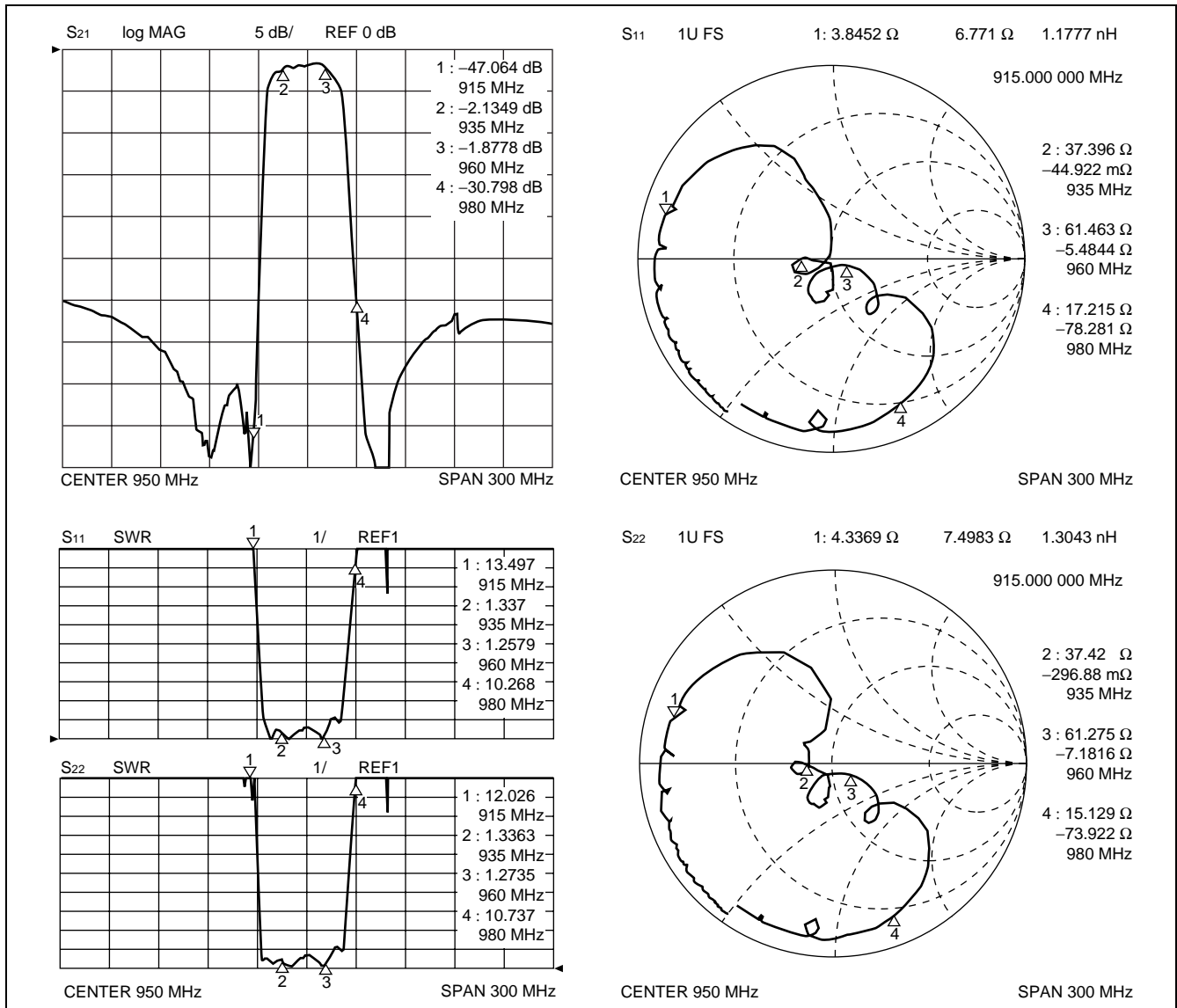

F5/F6 Series (K2 type)

9. EGSM (Tx)

Part number : FAR-F5CE-897M50-K226

(Ta = -30 °C to +85 °C)

Parameter	Conditions	Value			Unit	Remarks
		Min.	Typ.	Max.		
Insertion loss	880 MHz to 915 MHz	—	2.5	3.5	dB	
Pass-band ripple	880 MHz to 915 MHz	—	1.0	2.0	dB	
Absolute stop-band attenuation	DC to 845 MHz	20	23	—	dB	
	925 MHz to 935 MHz	4.5	8	—	dB	Ta = -30 °C to +25 °C
		7			dB	Ta = +25 °C to +85 °C
935 MHz to 2000 MHz	25	30	—	dB		
Pass-band VSWR (Return loss)	880 MHz to 915 MHz	— (6.8)	2.2 (8.5)	2.7 (—)	— (dB)	

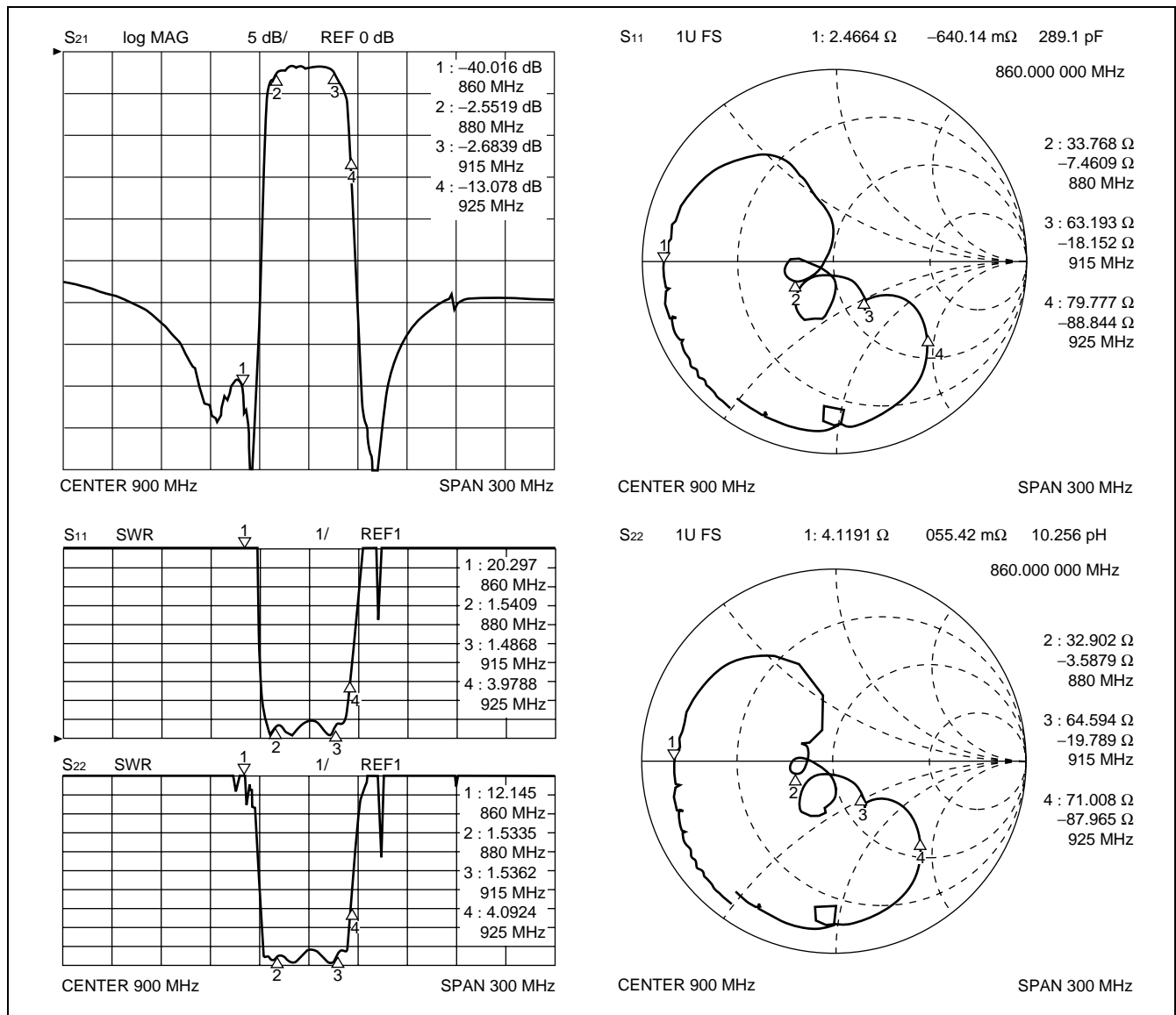

F5/F6 Series (K2 type)

10. EGSM (Tx) Low Loss type

Part number : FAR-F5CE-897M50-K231

(Ta = -30 °C to +85 °C)

Parameter	Conditions	Value			Unit	Remarks
		Min.	Typ.	Max.		
Insertion loss	880 MHz to 915 MHz	—	2.3	3.0	dB	
Pass-band ripple	880 MHz to 915 MHz	—	1.0	1.5	dB	
Absolute stop-band attenuation	DC to 800 MHz	17	19	—	dB	
	800 MHz to 860 MHz	15	25	—	dB	
	925 MHz to 935 MHz	4	—	—	dB	
	935 MHz to 960 MHz	20	25	—	dB	
	960 MHz to 1850 MHz	20	25	—	dB	
Pass-band VSWR (Return loss)	880 MHz to 915 MHz	—	2.0	2.2	—	
		(8.5)	(9.5)	(—)	(dB)	

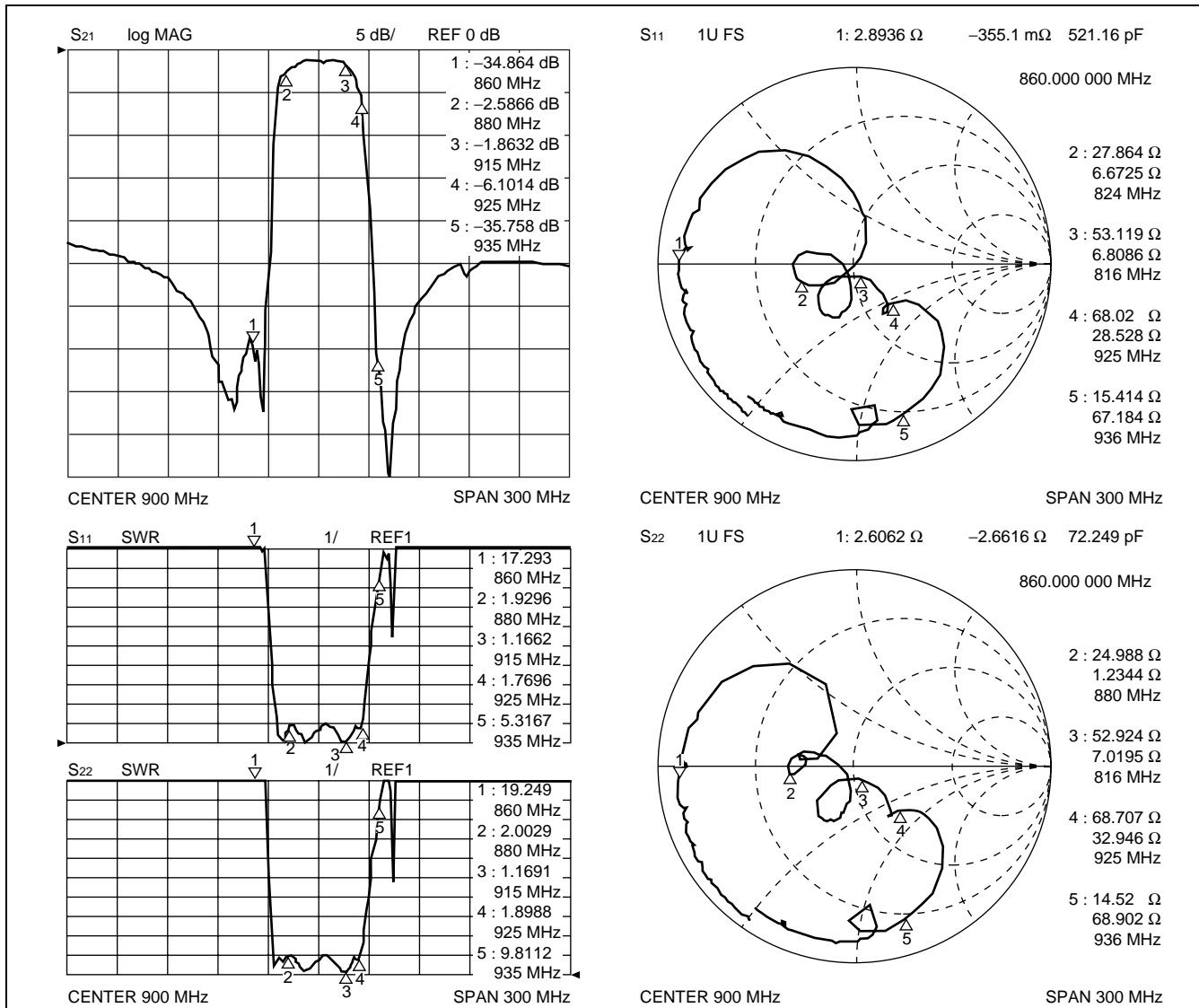

F5/F6 Series (K2 type)

11. EGSM (Rx) Low Loss type Part number : FAR-F5CE-942M50-K288

(Ta = -30 °C to +85 °C)

Parameter	Conditions	Value			Unit	Remarks
		Min.	Typ.	Max.		
Insertion loss	925 MHz to 960 MHz	—	2.0	2.5	dB	Ta = +25 °C ± 2 °C
				2.7	dB	Ta = -10 °C to +60 °C
				3.0	dB	Ta = -30 °C to +85 °C
Pass-band ripple	925 MHz to 960 MHz	—	0.5	1.5	dB	
Absolute stop-band attenuation	DC to 905 MHz	17	18	—	dB	
	905 MHz to 915 MHz	13	16	—	dB	Ta = +25 °C ± 2 °C
		8			dB	Ta = -10 °C to +60 °C
		5			dB	Ta = -30 °C to +85 °C
	980 MHz to 1000 MHz	13	20	—	dB	
1000 MHz to 2000 MHz	20	22	—	dB		
Pass-band VSWR (Return loss)	925 MHz to 960 MHz	— (6.8)	2.2 (8.5)	2.7 (—)	— (dB)	

(Continued)

F5/F6 Series (K2 type)

(Continued)

Part number : FAR-F5CE-942M50-K288

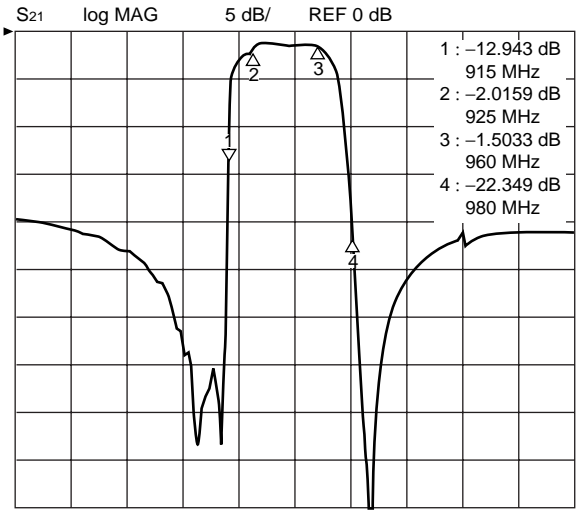

CENTER 950 MHz SPAN 300 MHz

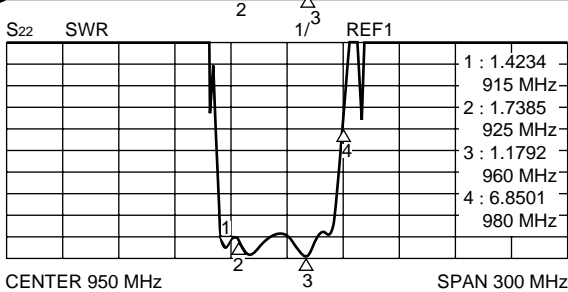
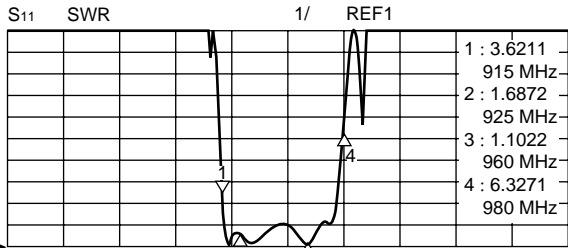

CENTER 950 MHz SPAN 300 MHz

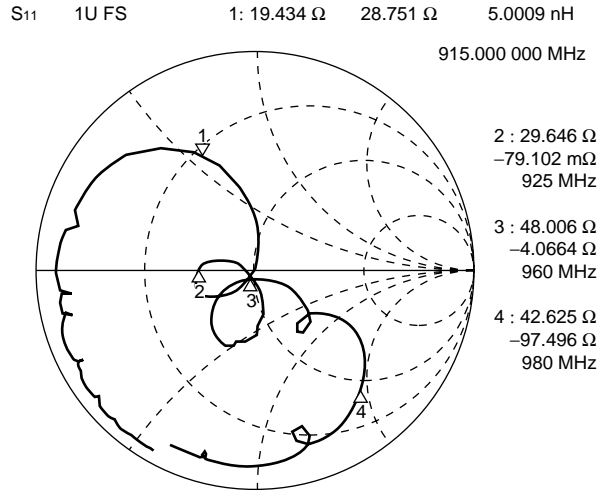

CENTER 950 MHz SPAN 300 MHz

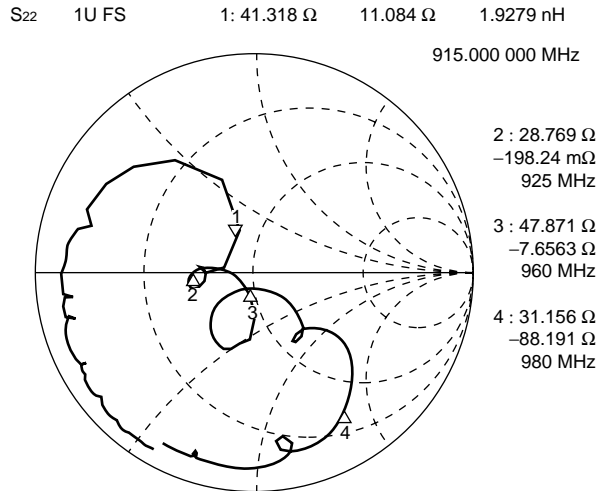

CENTER 950 MHz SPAN 300 MHz

F5/F6 Series (K2 type)

12. EGSM (Rx)

Part number : FAR-F5CE-942M50-K237

(Ta = -30 °C to +85 °C)

Parameter	Conditions	Value			Unit	Remarks
		Min.	Typ.	Max.		
Insertion loss	925 MHz to 960 MHz	—	2.5	3.0	dB	Ta = +10 °C to +60 °C
		—	—	3.5	dB	Ta = -30 °C to +85 °C
Pass-band ripple	925 MHz to 960 MHz	—	1.3	1.9	dB	
Absolute stop-band attenuation	DC to 100 MHz	30	33	—	dB	
	100 MHz to 700 MHz	23	25	—	dB	
	700 MHz to 800 MHz	25	28	—	dB	
	800 MHz to 890 MHz	28	31	—	dB	
	890 MHz to 905 MHz	35	41	—	dB	
	905 MHz to 915 MHz	15	20	—	dB	Ta = +25 °C ± 2 °C
		11	20	—	dB	Ta = +10 °C to +60 °C
		7	10	—	dB	Ta = -30 °C to +85 °C
	980 MHz to 1000 MHz	20	33	—	dB	
	1000 MHz to 1200 MHz	30	32	—	dB	
	1200 MHz to 1550 MHz	30	35	—	dB	
	1550 MHz to 1950 MHz	25	31	—	dB	
1950 MHz to 2800 MHz	20	27	—	dB		
2800 MHz to 3000 MHz	15	23	—	dB		
Pass-band VSWR (Return loss)	925 MHz to 960 MHz	— (6.5)	2.6 (7.0)	2.8 (—)	— (dB)	

(Continued)

F5/F6 Series (K2 type)

(Continued)

Part number : FAR-F5CE-942M50-K237

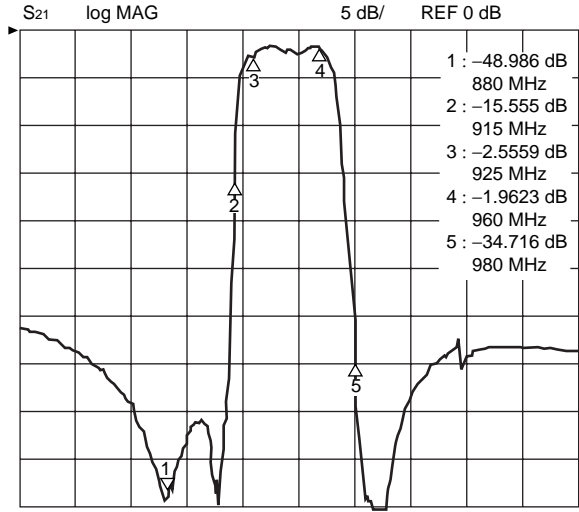

CENTER 950 MHz

SPAN 300 MHz

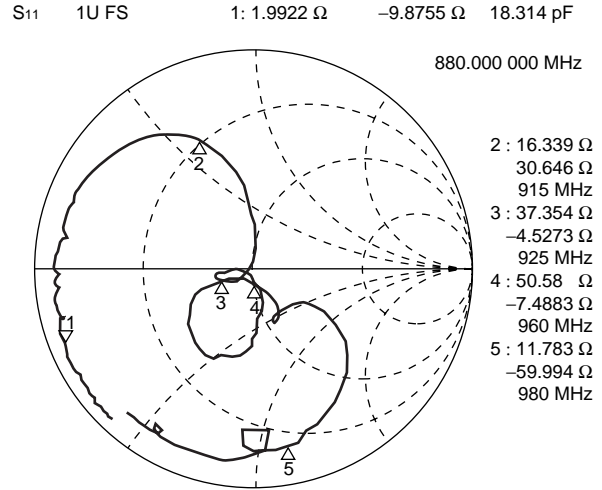

CENTER 950 MHz

SPAN 300 MHz

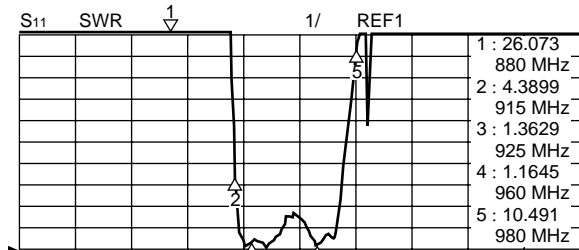

CENTER 950 MHz

SPAN 300 MHz

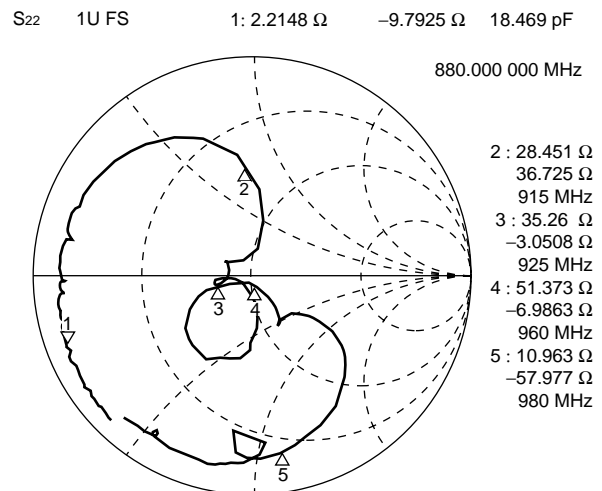

CENTER 950 MHz

SPAN 300 MHz

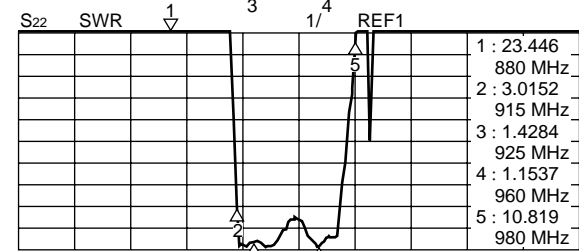

F5/F6 Series (K2 type)

13. PDC800 (Tx)

Part number : FAR-F5CE-950M00-K201

(Ta = -30 °C to +85 °C)

Parameter	Conditions	Value			Unit	Remarks
		Min.	Typ.	Max.		
Insertion loss	940 MHz to 960 MHz	—	3.0	3.5	dB	
Pass-band ripple	940 MHz to 960 MHz	—	1.5	2.0	dB	
Absolute stop-band attenuation	DC to 680 MHz	30	36	—	dB	
	680 MHz to 696 MHz	33	37	—	dB	
	810 MHz to 830 MHz	35	40	—	dB	
	1015 MHz to 1106 MHz	40	44	—	dB	
	1106 MHz to 2000 MHz	30	37	—	dB	
Pass-band VSWR (Return loss)	940 MHz to 960 MHz	— (7.4)	1.8 (10.9)	2.5 (—)	— (dB)	

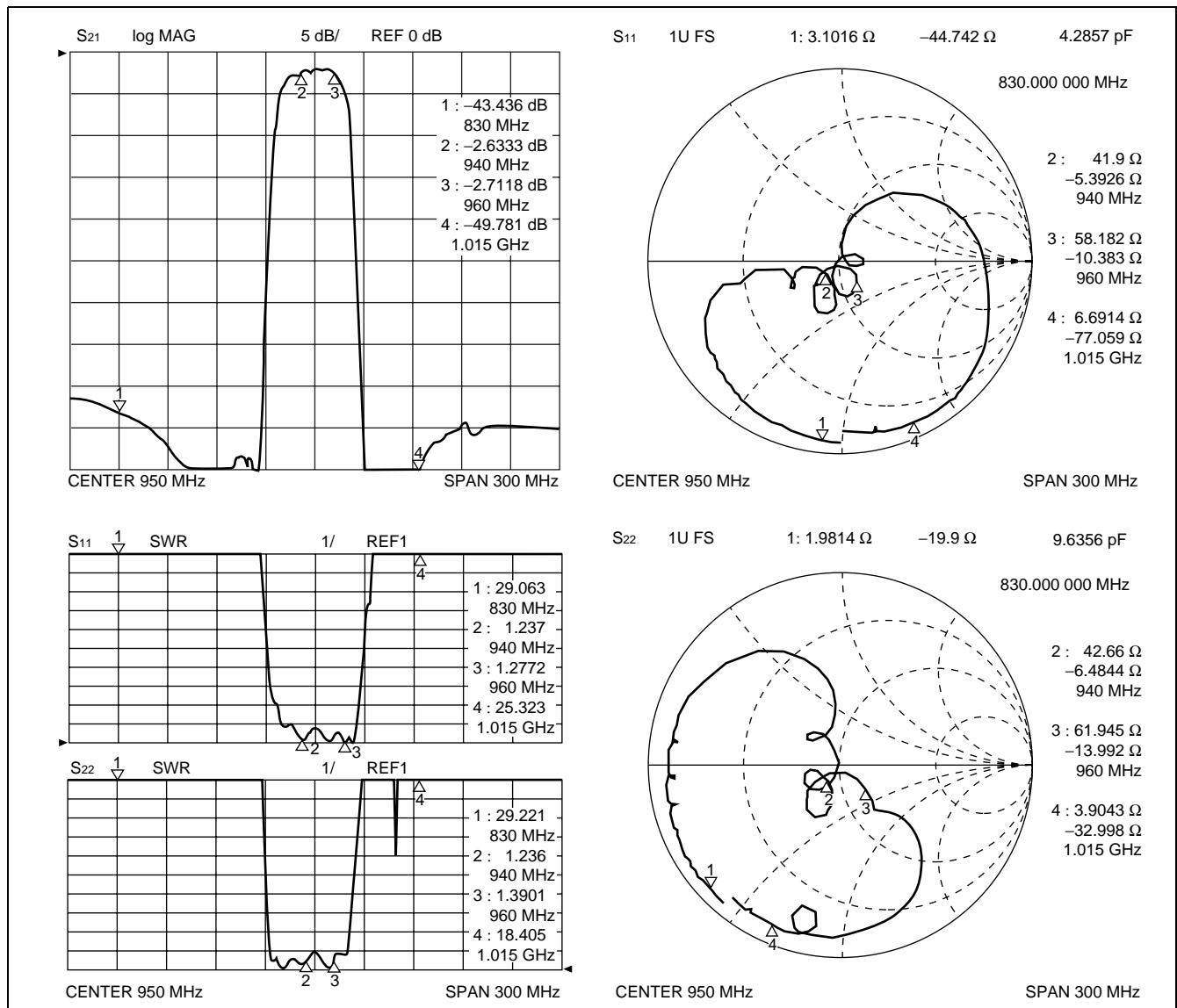

F5/F6 Series (K2 type)

14. PDC800 (Rx) Low Loss type Part number : FAR-F5CE-820M00-K202

(Ta = -30 °C to +85 °C)

Parameter	Conditions	Value			Unit	Remarks
		Min.	Typ.	Max.		
Insertion loss	810 MHz to 830 MHz	—	2.1	2.5	dB	
Pass-band ripple	810 MHz to 830 MHz	—	1.4	1.9	dB	
Absolute stop-band attenuation	DC to 700 MHz	20	24	—	dB	
	875 MHz to 1070 MHz	25	28	—	dB	
	1070 MHz to 1090 MHz	26	30	—	dB	
	1090 MHz to 2000 MHz	20	28	—	dB	
Pass-band VSWR (Return loss)	810 MHz to 830 MHz	— (9.5)	1.7 (11.7)	2.0 (—)	— (dB)	

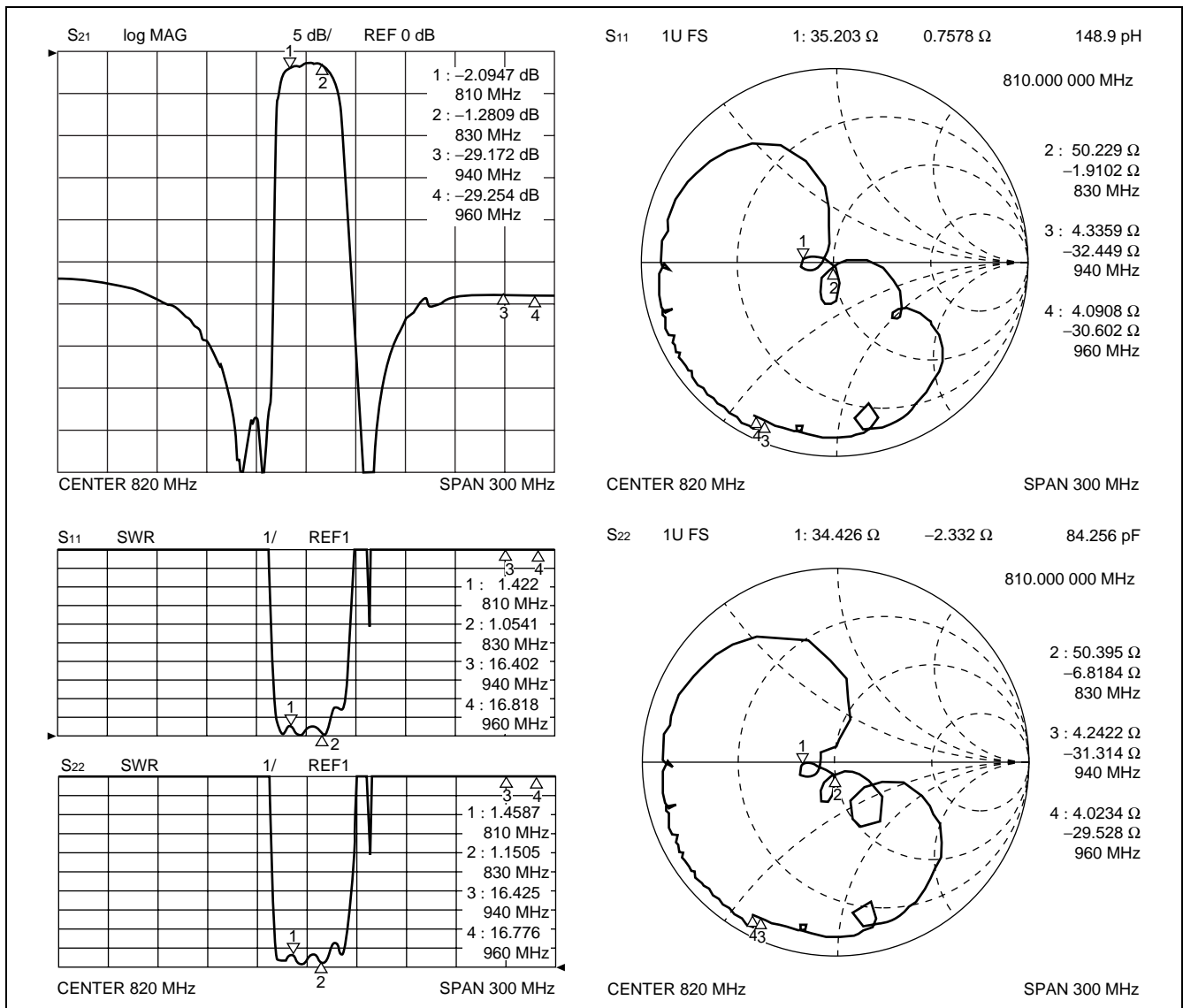

F5/F6 Series (K2 type)

15. PDC800 (Rx) High Attenuation type Part number : FAR-F5CE-820M00-K204

(Ta = -30 °C to +85 °C)

Parameter	Conditions	Value			Unit	Remarks
		Min.	Typ.	Max.		
Insertion loss	810 MHz to 830 MHz	—	3.0	3.5	dB	
Pass-band ripple	810 MHz to 830 MHz	—	1.5	2.0	dB	
Absolute stop-band attenuation	DC to 130 MHz	35	41	—	dB	
	130 MHz to 760 MHz	30	34	—	dB	
	855 MHz to 875 MHz	35	38	—	dB	
	875 MHz to 1090 MHz	33	38	—	dB	
Pass-band VSWR (Return loss)	810 MHz to 830 MHz	— (7.4)	2.0 (9.5)	2.5 (—)	— (dB)	

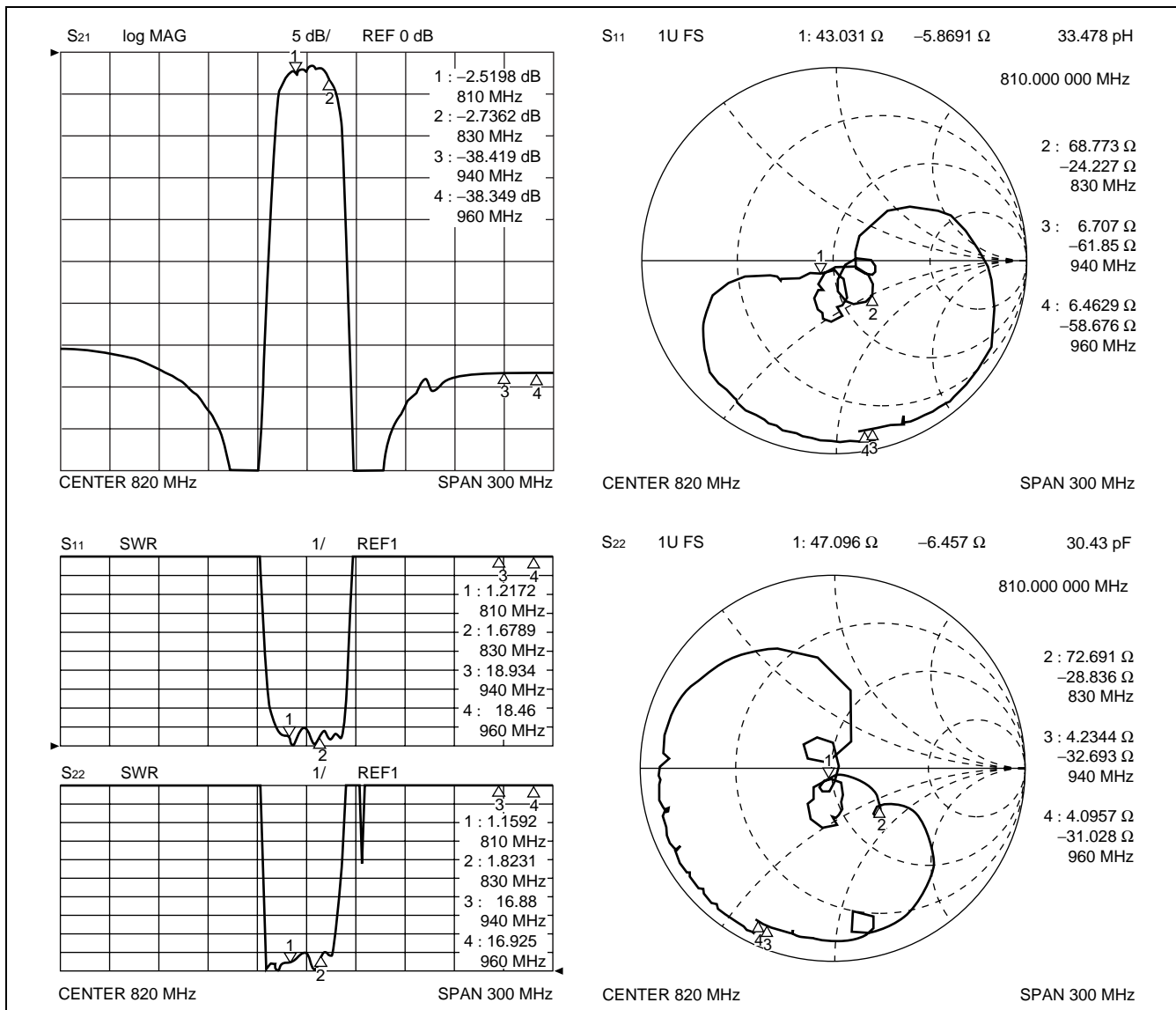

F5/F6 Series (K2 type)

16. J-CDMA (Tx)

Part number : FAR-F5CE-906M00-K219

(Ta = -30 °C to +85 °C)

Parameter	Conditions	Value			Unit	Remarks
		Min.	Typ.	Max.		
Insertion loss	887 MHz to 925 MHz	—	2.7	3.7	dB	
Pass-band ripple	887 MHz to 925 MHz	—	1.0	2.2	dB	
Absolute stop-band attenuation	DC to 720 MHz	20	22	—	dB	
	720 MHz to 800 MHz	20	23	—	dB	
	832 MHz to 870 MHz	32	33	—	dB	
	940 MHz to 942 MHz	15	25	—	dB	
	942 MHz to 950 MHz	20	30	—	dB	
	950 MHz to 2000 MHz	20	23	—	dB	
Pass-band VSWR (Return loss)	887 MHz to 925 MHz	—	2.2	2.7	—	
		(6.8)	(8.5)	(—)	(dB)	

(Continued)

F5/F6 Series (K2 type)

(Continued)

Part number : FAR-F5CE-906M00-K219

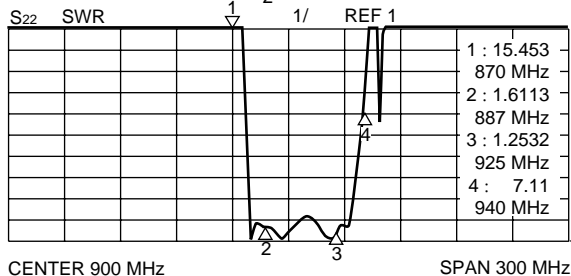
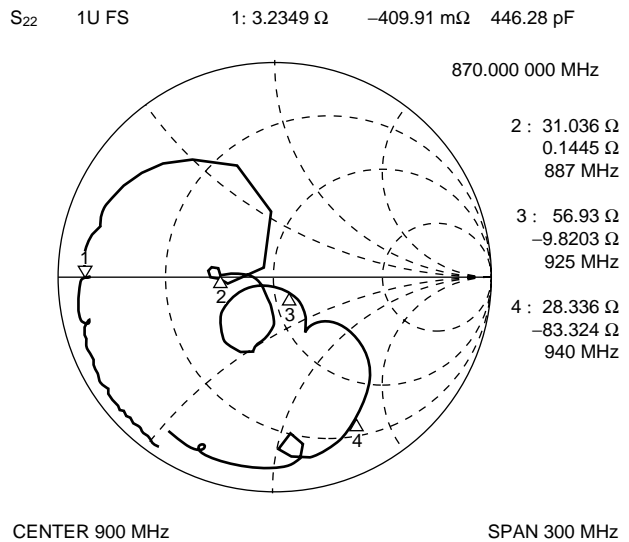
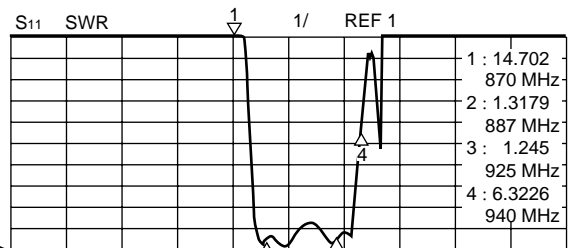
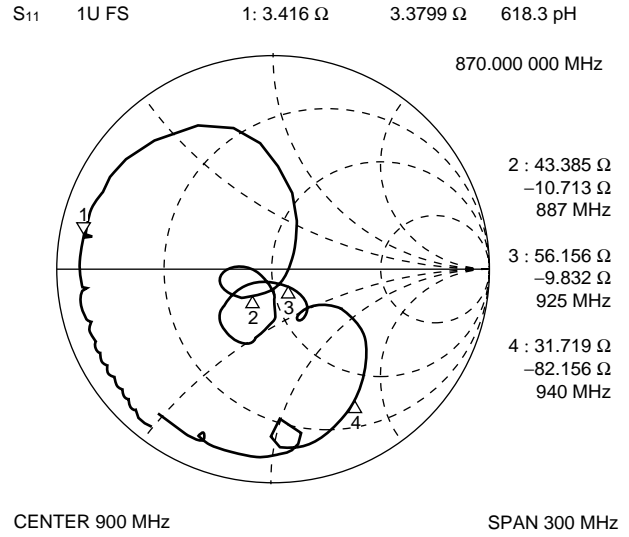
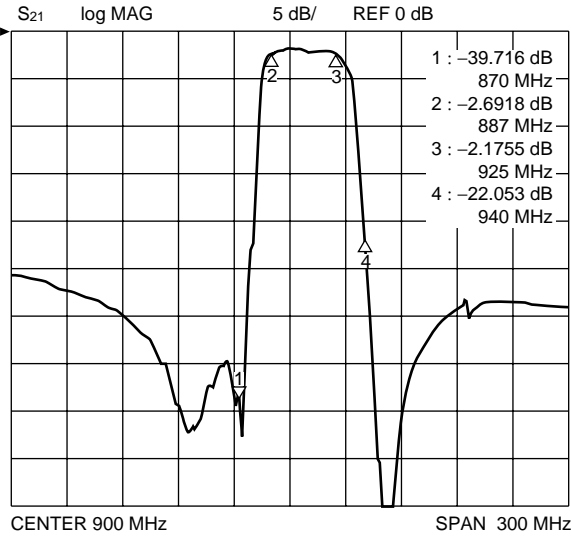

F5/F6 Series (K2 type)

17. J-CDMA (Tx) High Attenuation type Part number : FAR-F5CE-906M00-K215

(Ta = -30 °C to +85 °C)

Parameter	Conditions	Value			Unit	Remarks
		Min.	Typ.	Max.		
Insertion loss	887 MHz to 925 MHz	—	3.0	4.5	dB	
Pass-band ripple	887 MHz to 925 MHz	—	1.5	3.0	dB	
Absolute stop-band attenuation	DC to 720 MHz	25	26	—	dB	
	720 MHz to 800 MHz	25	30	—	dB	
	832 MHz to 870 MHz	30	35	—	dB	
	940 MHz to 942 MHz	20	25	—	dB	
	942 MHz to 950 MHz	25	30	—	dB	
	950 MHz to 2000 MHz	20	25	—	dB	
	2000 MHz to 3000 MHz	15	20	—	dB	
Pass-band VSWR (Return loss)	887 MHz to 925 MHz	— (5.1)	3.0 (6.0)	3.5 (—)	— (dB)	

(Continued)

F5/F6 Series (K2 type)

(Continued)

Part number : FAR-F5CE-906M00-K215

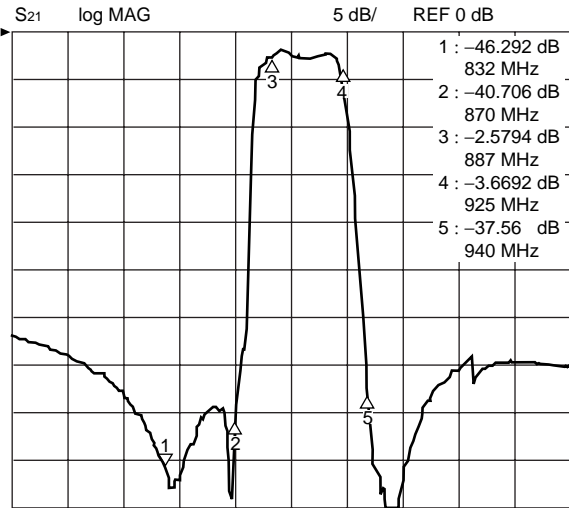

CENTER 900 MHz SPAN 300 MHz

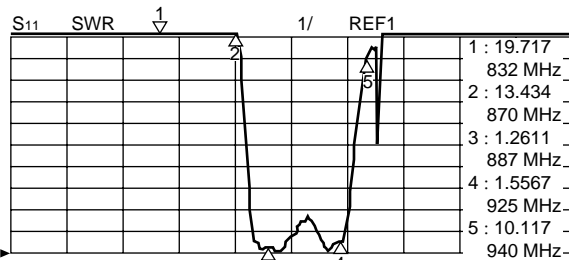

CENTER 900 MHz SPAN 300 MHz

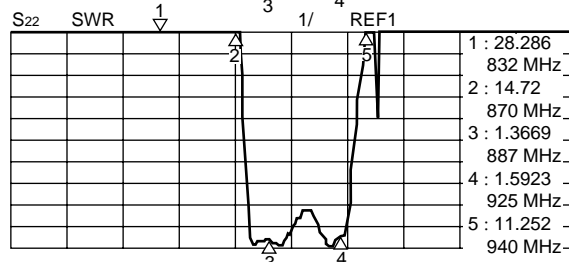

CENTER 900 MHz SPAN 300 MHz

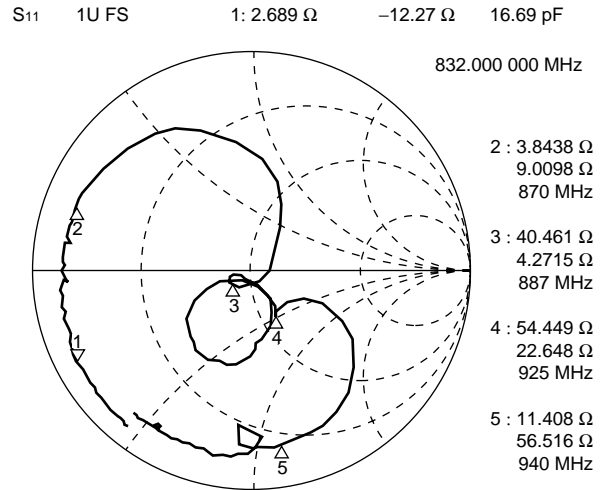

CENTER 900 MHz SPAN 300 MHz

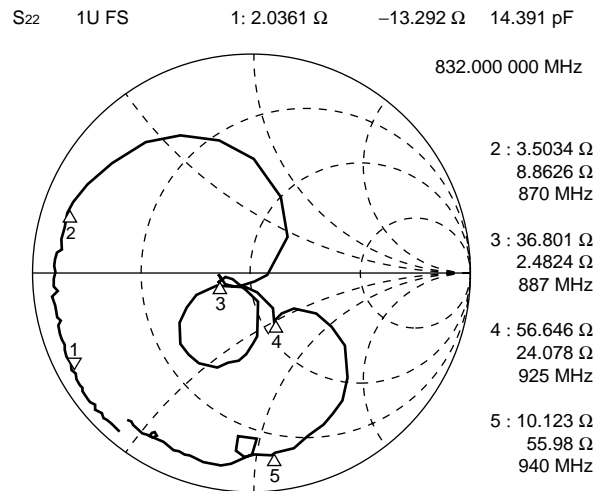

CENTER 900 MHz SPAN 300 MHz

F5/F6 Series (K2 type)

18. J-CDMA (Tx)

Part number : FAR-F5CE-906M00-K238

(Ta = -30 °C to +85 °C)

Parameter	Conditions	Value			Unit	Remarks
		Min.	Typ.	Max.		
Insertion loss	887 MHz to 925 MHz	—	2.7	4.0	dB	
Pass-band ripple	887 MHz to 925 MHz	—	1.0	2.3	dB	
Absolute stop-band attenuation	DC to 720 MHz	23	25	—	dB	
	720 MHz to 800 MHz	25	27	—	dB	
	832 MHz to 870 MHz	37	40	—	dB	
	940 MHz to 942 MHz	15	23	—	dB	
	942 MHz to 950 MHz	20	28	—	dB	
	950 MHz to 2000 MHz	25	30	—	dB	
2000 MHz to 3000 MHz	20	25	—	dB		
Pass-band VSWR (Return loss)	887 MHz to 925 MHz	— (5.6)	2.2 (8.5)	3.2 (—)	— (dB)	

(Continued)

F5/F6 Series (K2 type)

(Continued)

Part number : FAR-F5CE-906M00-K238

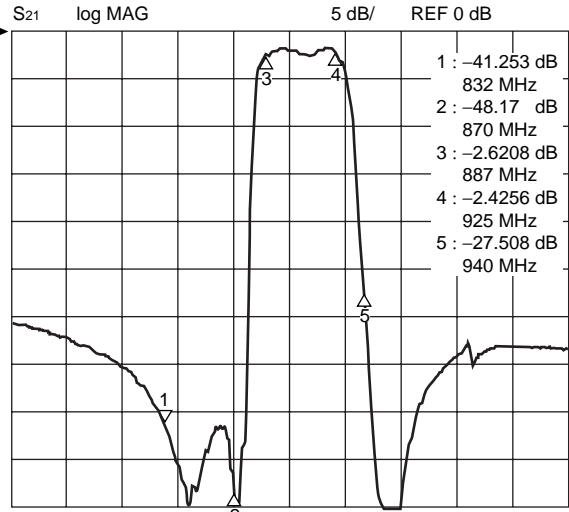

CENTER 900 MHz SPAN 300 MHz

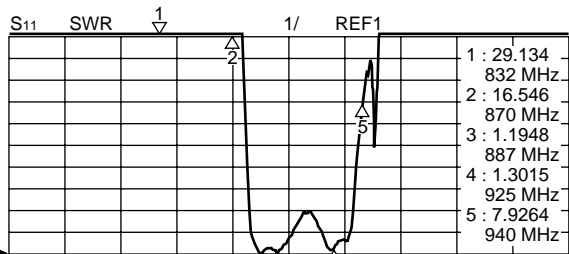

CENTER 900 MHz SPAN 300 MHz

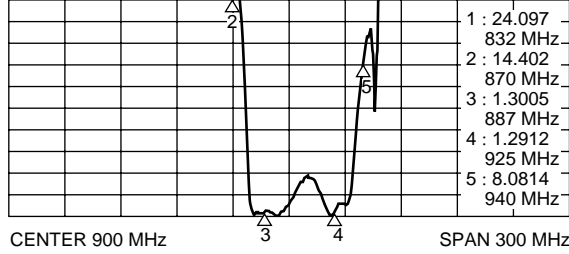

CENTER 900 MHz SPAN 300 MHz

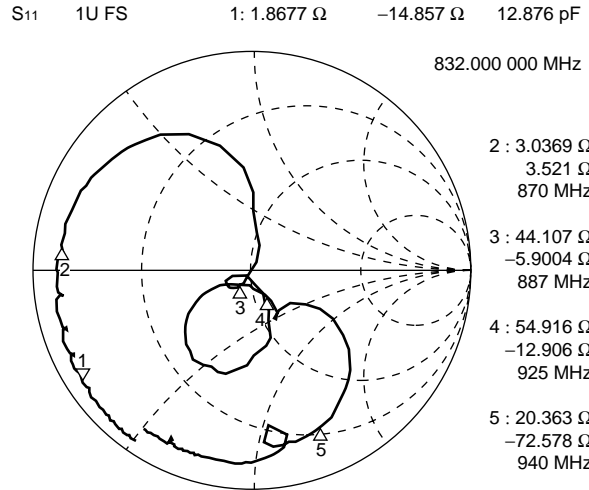

CENTER 900 MHz SPAN 300 MHz

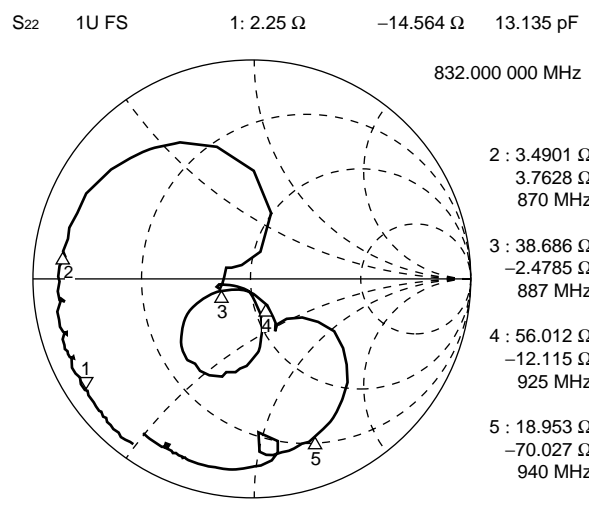

CENTER 900 MHz SPAN 300 MHz

F5/F6 Series (K2 type)

19. J-CDMA (Rx)

Part number : FAR-F5CE-851M00-K212

(Ta = -30 °C to +85 °C)

Parameter	Conditions	Value			Unit	Remarks
		Min.	Typ.	Max.		
Insertion loss	832 MHz to 870 MHz	—	2.5	3.5	dB	
Pass-band ripple	832 MHz to 870 MHz	—	1.0	2.0	dB	
Absolute stop-band attenuation	DC to 170 MHz	20	24	—	dB	
	170 MHz to 720 MHz	18	20	—	dB	
	720 MHz to 770 MHz	20	22	—	dB	
	770 MHz to 815 MHz	25	27	—	dB	
	818 MHz	15	40	—	dB	
	887 MHz to 897 MHz	20	30	—	dB	
	897 MHz to 925 MHz	23	25	—	dB	
	925 MHz to 1100 MHz	22	24	—	dB	
1100 MHz to 2000 MHz	20	24	—	dB		
Pass-band VSWR (Return loss)	832 MHz to 870 MHz	— (6.0)	2.7 (6.8)	3.0 (—)	— (dB)	

(Continued)

F5/F6 Series (K2 type)

(Continued)

Part number : FAR-F5CE-851M00-K212

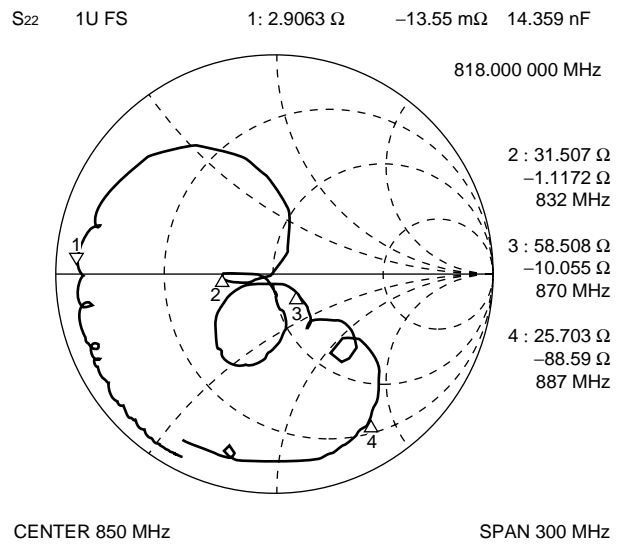
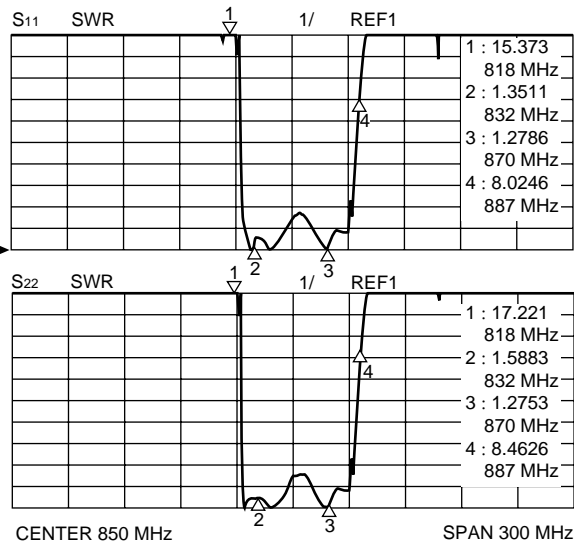
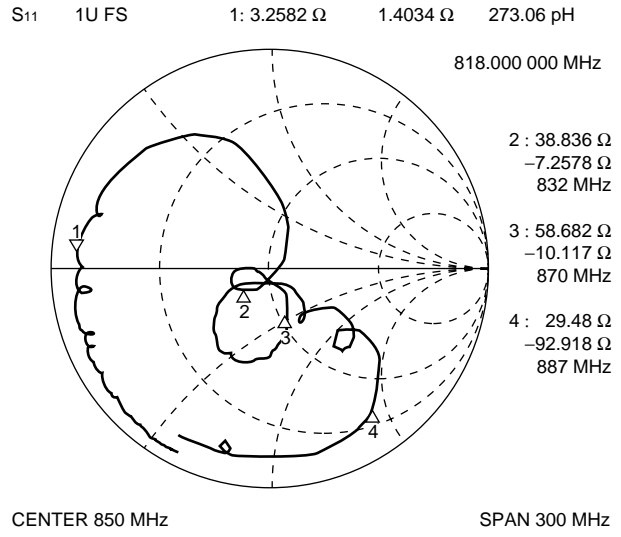
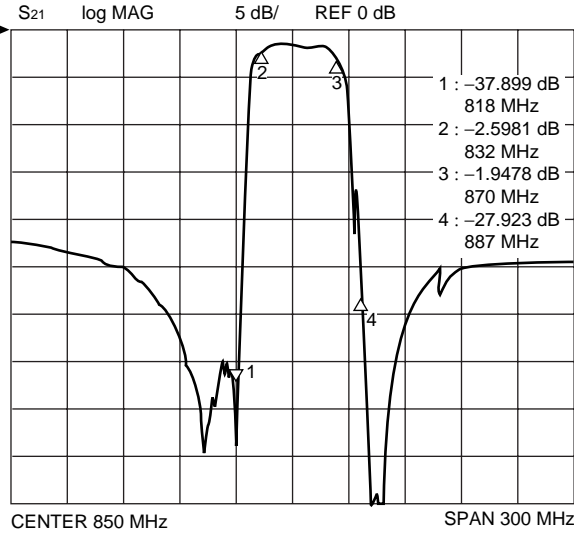

F5/F6 Series (K2 type)

20. PDC1.5 G (Tx) High Attenuation type Part number : FAR-F6CE-1G4410-K220

(Ta = -30 °C to +85 °C)

Parameter	Conditions	Value			Unit	Remarks
		Min.	Typ.	Max.		
Insertion loss	1429 MHz to 1453 MHz	—	2.2	3.0	dB	
Pass-band ripple	1429 MHz to 1453 MHz	—	1.0	2.0	dB	
Absolute stop-band attenuation	DC to 1380 MHz	25	27	—	dB	
	1477 MHz to 1501 MHz	10	18	—	dB	
	1501 MHz to 1900 MHz	30	32	—	dB	
	1900 MHz to 2906 MHz	18	28	—	dB	
Pass-band VSWR (Return loss)	1429 MHz to 1453 MHz	— (7.4)	2.1 (9.0)	2.5 (—)	— (dB)	

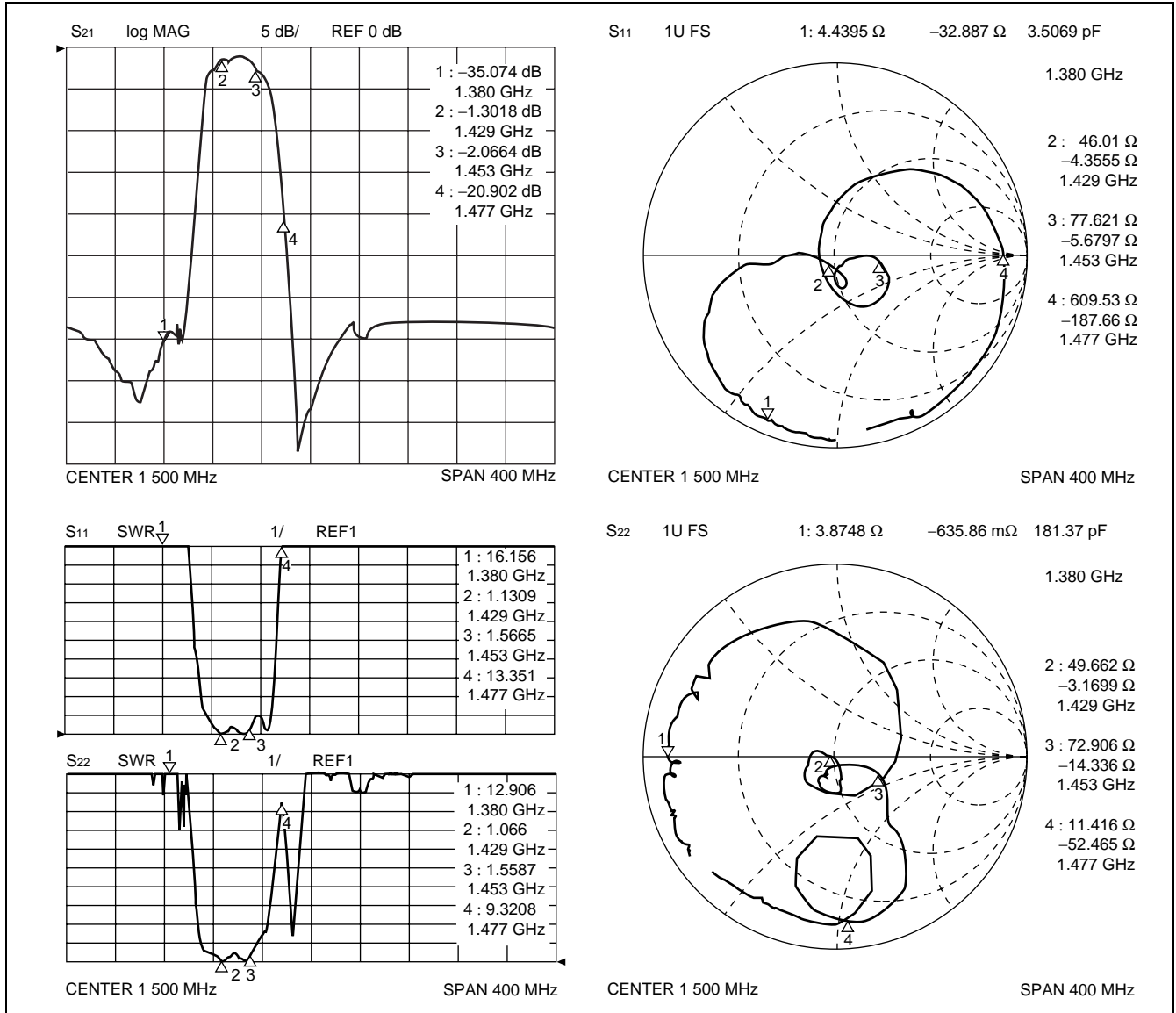

F5/F6 Series (K2 type)

21. PDC1.5 G (Rx) High Attenuation type Part number : FAR-F6CE-1G4890-K221

(Ta = -30 °C to +85 °C)

Parameter	Conditions	Value			Unit	Remarks
		Min.	Typ.	Max.		
Insertion loss	1477 MHz to 1501 MHz	—	2.5	3.0	dB	
Pass-band ripple	1477 MHz to 1501 MHz	—	1.0	2.0	dB	
Absolute stop-band attenuation	DC to 1429 MHz	25	28	—	dB	
	1429 MHz to 1453 MHz	10	25	—	dB	
	1542 MHz to 1566 MHz	20	28	—	dB	
	1566 MHz to 1900 MHz	30	33	—	dB	
	1900 MHz to 3000 MHz	20	29	—	dB	
Pass-band VSWR (Return loss)	1477 MHz to 1501 MHz	— (6.8)	2.4 (7.7)	2.7 (—)	— (dB)	

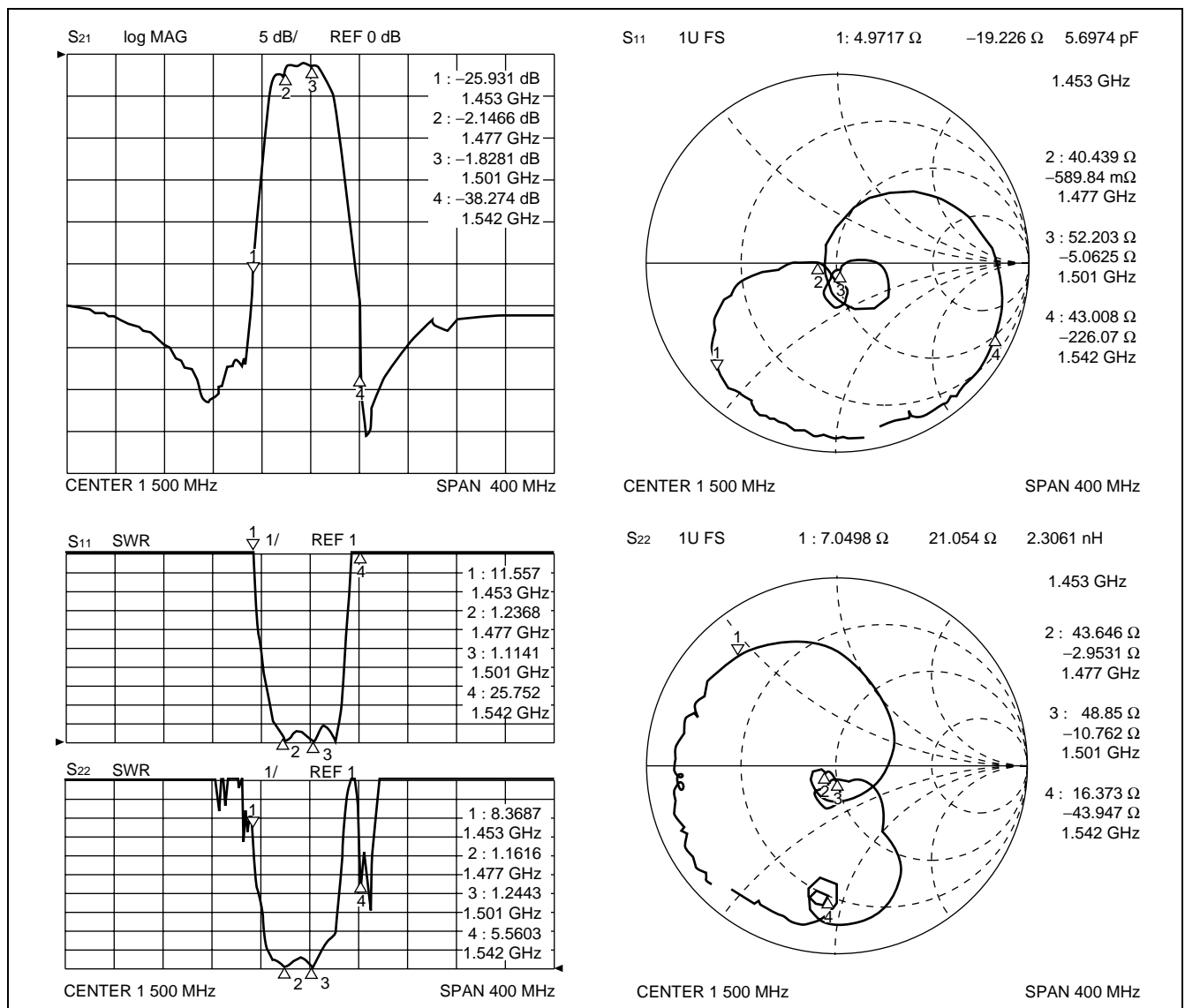

F5/F6 Series (K2 type)

22. PDC1.5 G (Lo)

Part number : FAR-F6CE-1G6190-K222

(Ta = -30 °C to +85 °C)

Parameter	Conditions	Value			Unit	Remarks
		Min.	Typ.	Max.		
Insertion loss	1607 MHz to 1631 MHz	—	2.4	3.3	dB	
Pass-band ripple	1607 MHz to 1631 MHz	—	1.0	2.0	dB	
Absolute stop-band attenuation	DC to 130 MHz	30	38	—	dB	
	130 MHz to 1501 MHz	25	28	—	dB	
	1737 MHz to 1809 MHz	30	35	—	dB	
	1809 MHz to 2500 MHz	25	35	—	dB	
Pass-band VSWR (Return loss)	1607 MHz to 1631 MHz	— (9.5)	1.8 (10.9)	2.0 (—)	— (dB)	

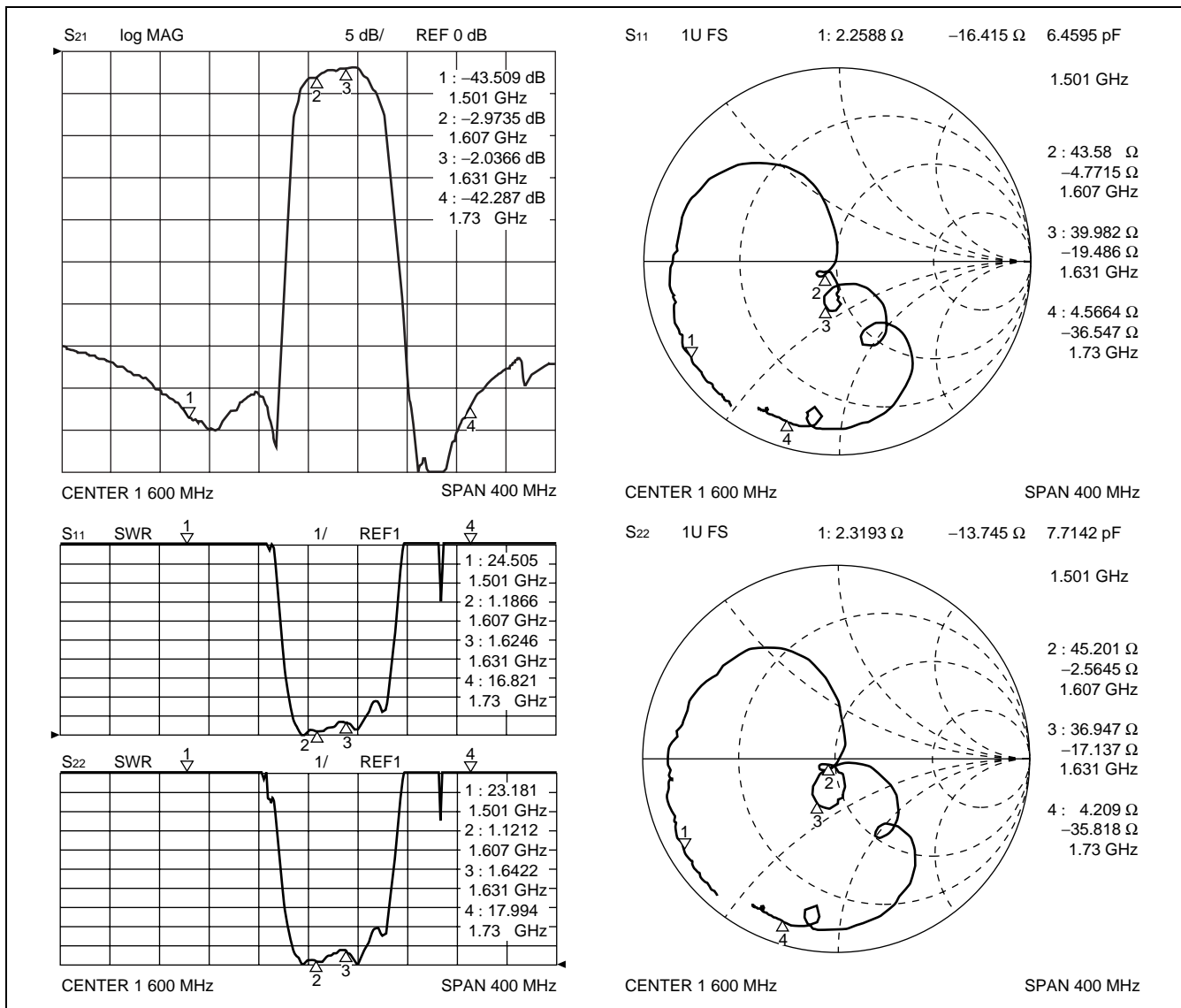

F5/F6 Series (K2 type)

MEASUREMENT CIRCUIT

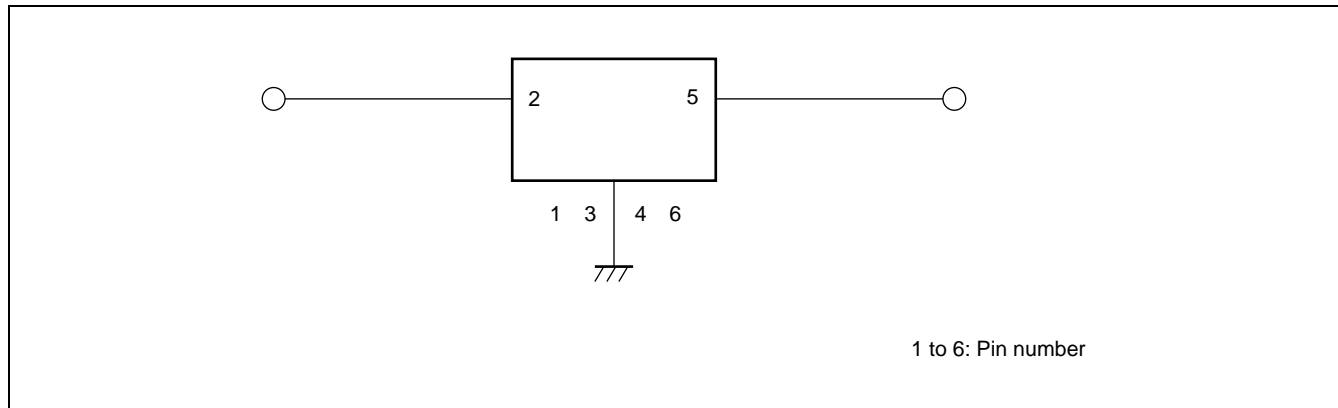

PART NUMBER DESIGNATION

[Designation example]

FAR-F□ CE-□□□□□□-K2 □□-□
(1) (2) (3) (4) (5)

- (1) Frequency range : 5 : 700 MHz to 1000 MHz
6 : 1000 MHz to 1700 MHz
- (2) Package size : E : 3.0 mm × 3.0 mm × 1.2 mm
- (3) Frequency : This specifies the nominal center frequency using six alphanumeric.
M (for MHz) or G (for GHz) indicates the decimal point.
[Example] 906.0 MHz ⇒ 906M00
1.441GHz ⇒ 1G4410
- (4) Part symbol : Numbers specified by FUJITSU MEDIA DEVICE
Refer to "■STANDARD DEVICES".
- (5) Packing (Reeled tape) : Y : 1 k pcs/reel
X : 5 k pcs/reel

F5/F6 Series (K2 type)

■ MARKING

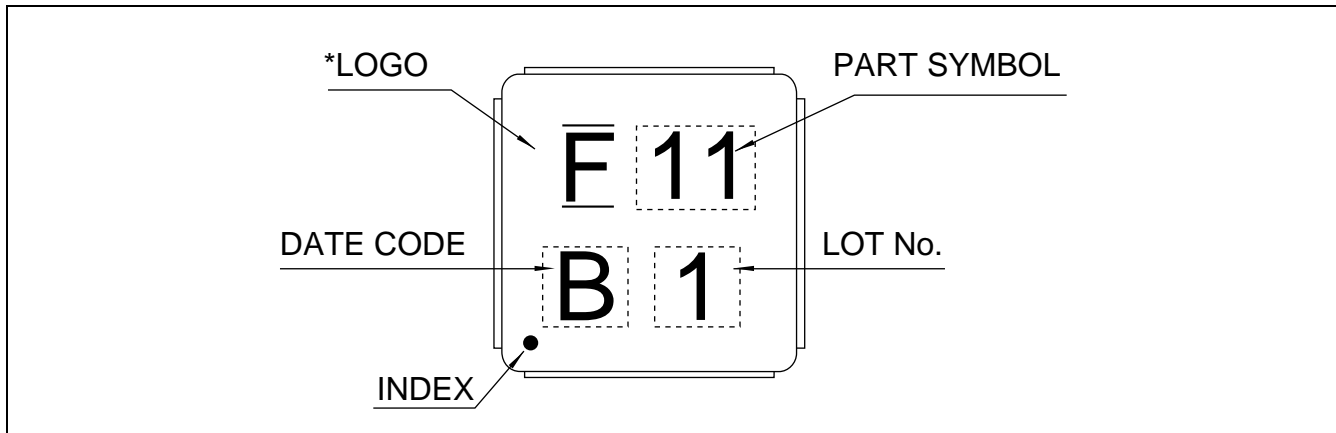

*: For the following parts, "K" is marked in place of "F".

FAR-F5CE-836M50-K230
FAR-F5CE-836M50-K236
FAR-F5CE-881M50-K235
FAR-F5CE-947M50-K233
FAR-F5CE-897M50-K231
FAR-F5CE-942M50-K237
FAR-F5CE-906M50-K238

F5/F6 Series (K2 type)

■ PACKAGE DIMENSION

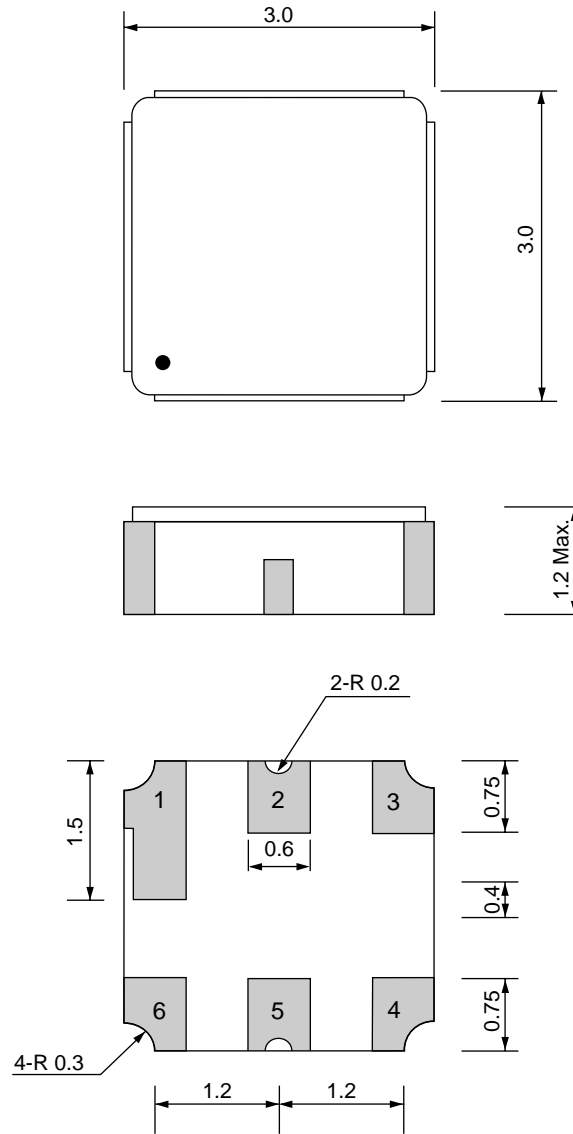

Dimensions in mm.

F5/F6 Series (K2 type)

RECOMMENDED LAND PATTERN

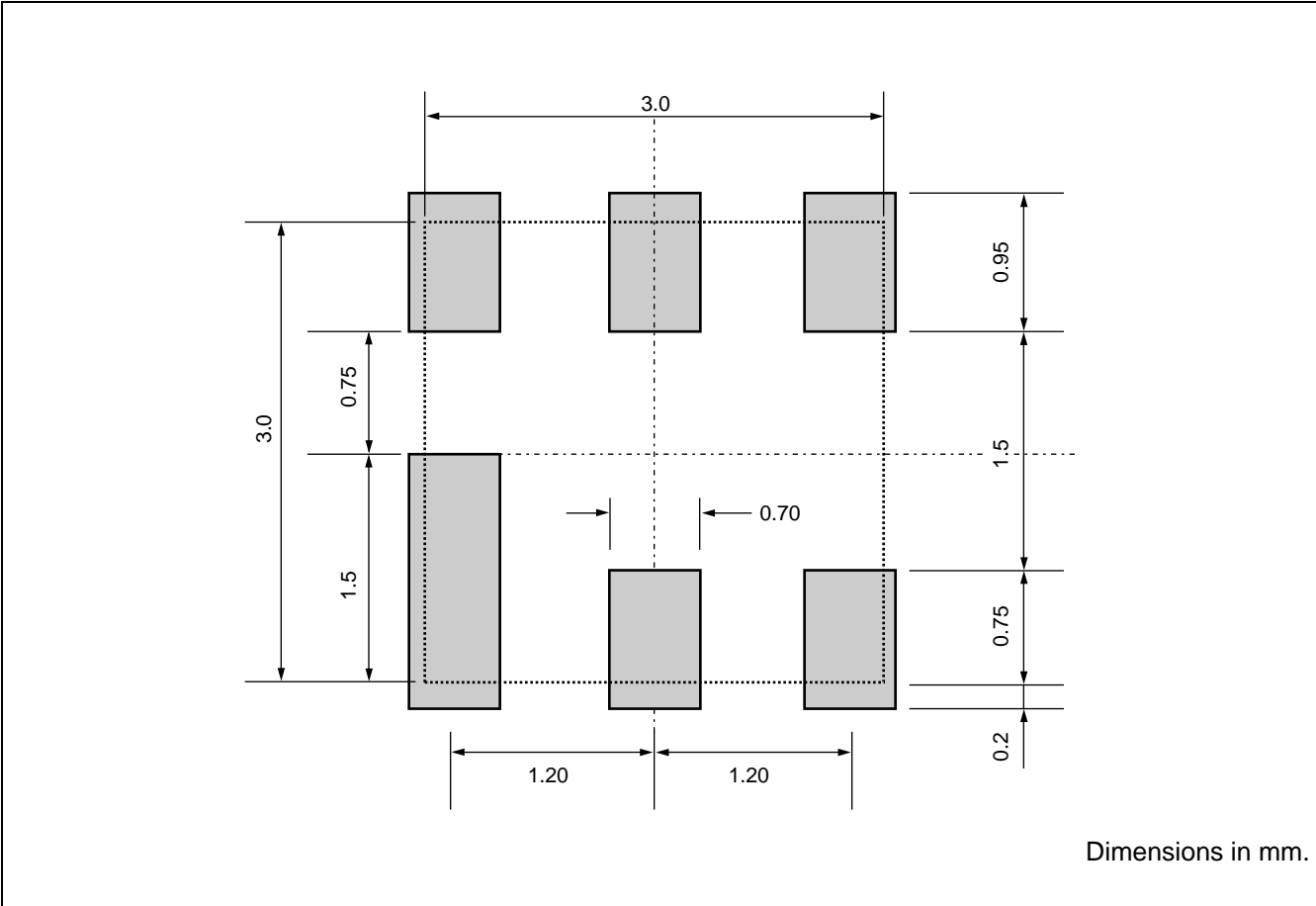

F5/F6 Series (K2 type)

■ PACKING

1. Reel Dimensions

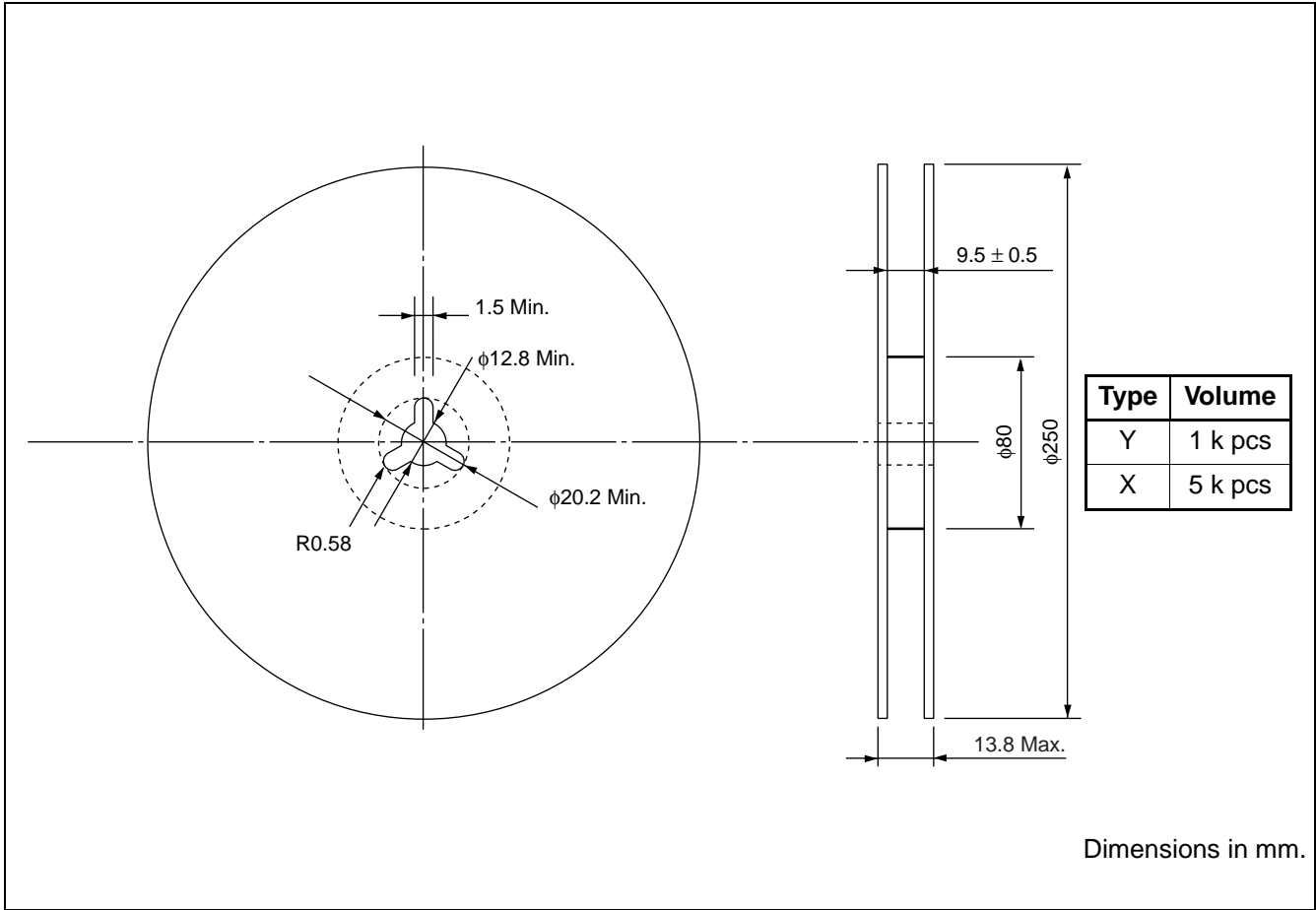

2. Packing Style

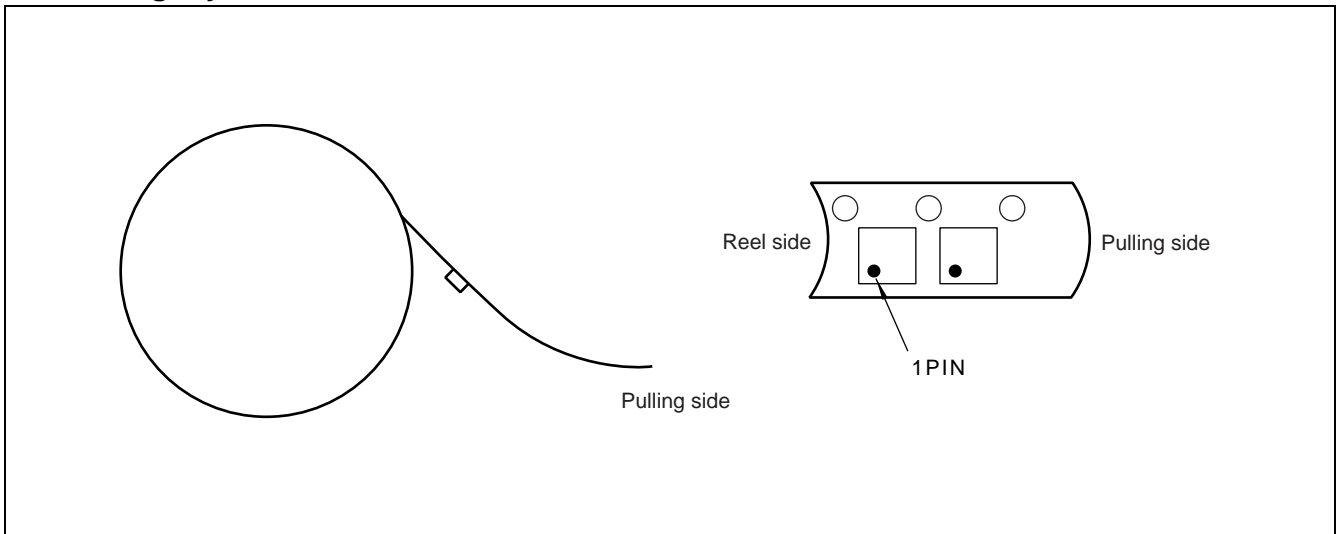

F5/F6 Series (K2 type)

3. Tape Dimensions

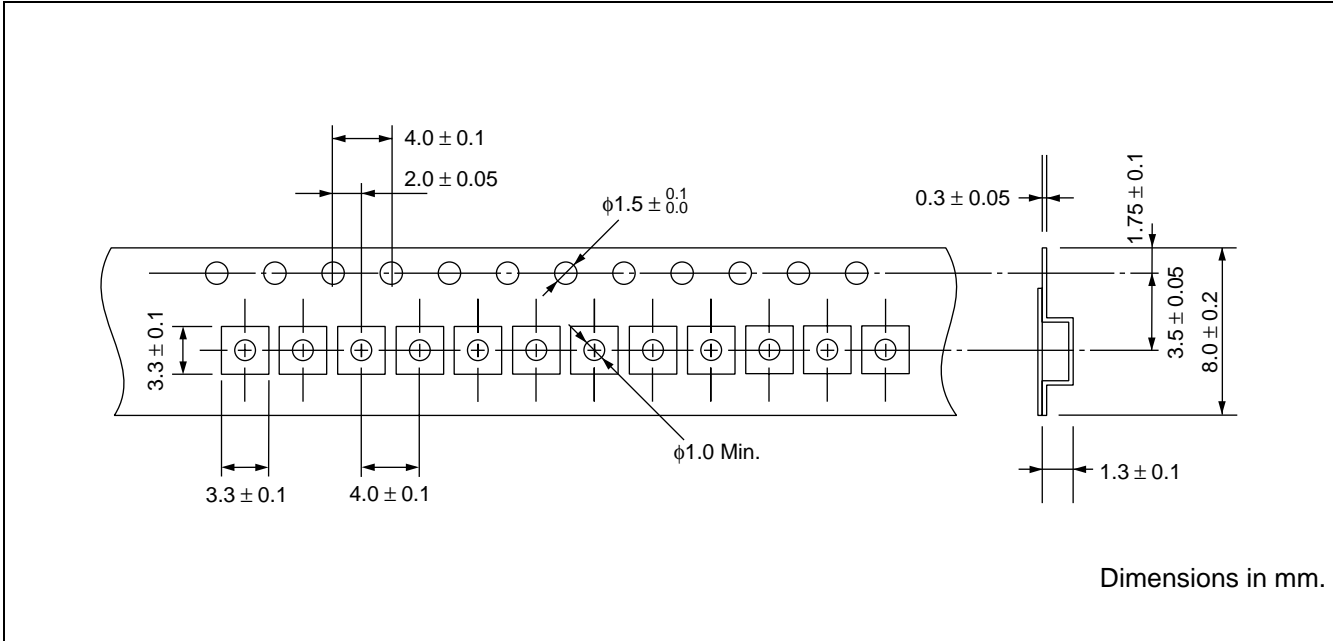

4. Peel strength of top cover tape

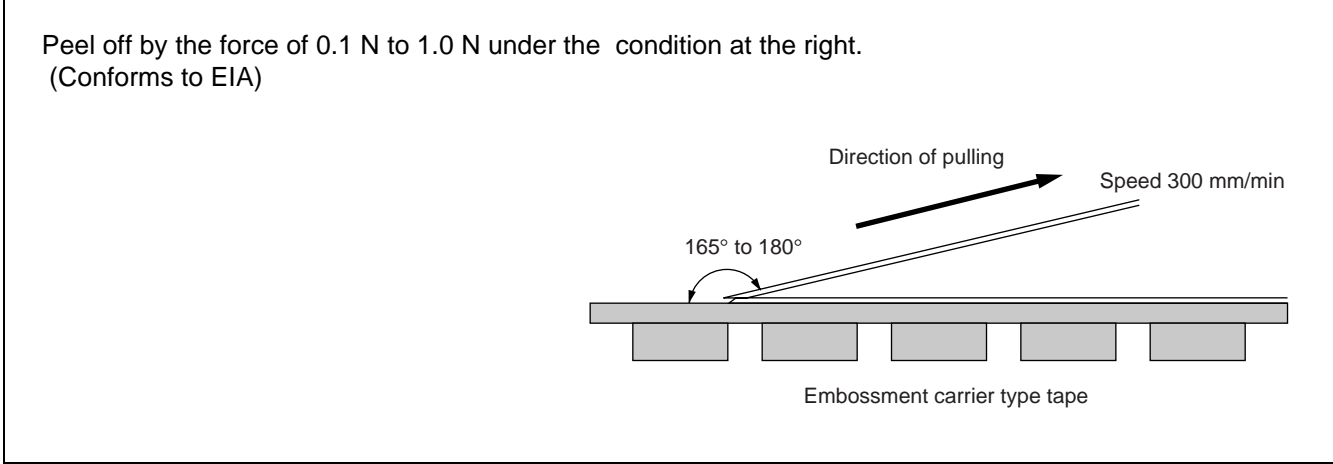

F5/F6 Series (K2 type)

RECOMMENDED REFLOW PROFILE

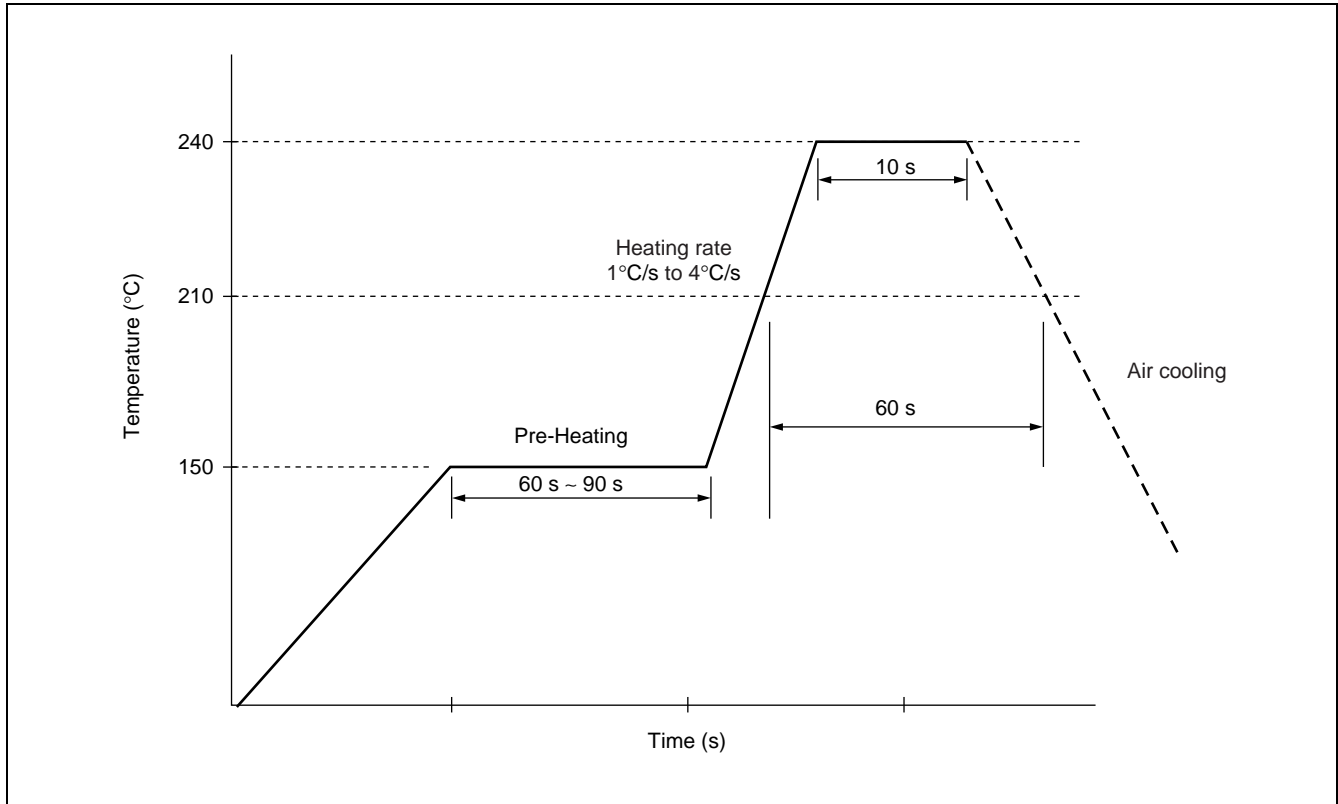

NOTE

A mass-produced product order is accepted by a unit of 1000.

F5/F6 Series (K2 type)

FUJITSU MEDIA DEVICES LIMITED

For further information please contact:

Japan

FUJITSU MEDIA DEVICE LIMITED
International Sales & Marketing DEPT.
Shin-Yokohama Square Bldg., 14F,
Shin-yokohama 2-3-12,
Kohoku-ku, Yokohama,
Kanagawa 222-0033, Japan
Tel: +81-45-471-0061
Fax: +81-45-471-0076

<http://edevice.fujitsu.com/fmd/>

North and South America

FUJITSU MEDIA DEVICES OF AMERICA, INC.
1731 Technology Drive, Suite 800,
San Jose, CA 95110 U.S.A.
Tel: (1)-408-437-8900
Fax: (1)-408-437-0700

<http://www.fujitsumedia.com/>

Europe

FUJITSU MICROELECTRONICS EUROPE GmbH
Am Siebenstein 6-10,
D-63303 Dreieich-Buchsschlag,
Germany
Tel: +49-6103-690-0
Fax: +49-6103-690-122

<http://www.fujitsu-fme.com/>

Asia Pacific

FUJITSU MICROELECTRONICS ASIA PTE. LTD.
#05-08, 151 Lorong Chuan,
New Tech Park,
Singapore 556741
Tel: +65-281-0770
Fax: +65-281-0220

<http://www.fmal.fujitsu.com/>

F0107

© FUJITSU LIMITED Printed in Japan

All Rights Reserved.

The contents of this document are subject to change without notice. Customers are advised to consult with FUJITSU MEDIA DEVICES sales representatives before ordering.

The information and circuit diagrams in this document are presented as examples of device applications, and are not intended to be incorporated in devices for actual use. Also, FUJITSU MEDIA DEVICES is unable to assume responsibility for infringement of any patent rights or other rights of third parties arising from the use of this information or circuit diagrams.

The products described in this document are designed, and manufactured as contemplated for general use, including without limitation, ordinary industrial use, general office use, personal use, and household use, but are not designed, developed and manufactured as contemplated (1) for use accompanying fatal risks or dangers that, unless extremely high safety is secured, could have a serious effect to the public, and could lead directly to death, personal injury, severe physical damage or other loss (i.e., nuclear reaction control in nuclear facility, aircraft flight control, air traffic control, mass transport control, medical life support system, missile launch control in weapon system), or (2) for use requiring extremely high reliability (i.e., submersible repeater and artificial satellite).

Please note that Fujitsu will not be liable against you and/or any third party for any claims or damages arising in connection with above-mentioned uses of the products.

Any electronic devices have inherently a certain rate of failure. You must protect against injury, damage or loss from such failures by incorporating safety design measures into your facility and equipment such as redundancy, fire protection, and prevention of over-current levels and other abnormal operating conditions.

If any products described in this document represent goods or technologies subject to certain restrictions on export under the Foreign Exchange and Foreign Trade Control Law of Japan, the prior authorization by Japanese government should be required for export of those products from Japan.