

*ASSP Mobile Communication Systems***Piezoelectric SAW Dual BPF
(700 MHz to 2000 MHz)****G5/G6 Series (L2/D2 type)****DESCRIPTION**

As the market for mobile phones continues to increase, so has demand for smaller size, lighter weight and lower cost. Dual band phones, such as GSM + PCN and AMPS + PCS, are rising in popularity. To support these requests, Fujitsu has developed a new series of SAW dual filter (G5/G6 series) incorporating two SAW filters in one package. For example, Fujitsu can offer a GSM Rx filter and a PCN Rx filter of combination in small 3.8 mm × 3.8 mm. package.

The G5/G6 series of SAW dual filter applies to the 700 MHz to 2000 MHz, frequency range, and are available in two package types : 2 input/2 output type or 1 input/2 output (2 input/1 output) .

FEATURES

- Two functions are incorporated in one package
(Useful for multi-band phone and multi-mode phone)
- Ultra compact and light package (3.8 mm × 3.8 mm. or 3.0 mm × 3.0 mm.)
- 50 Ω of input/output impedance
- Low insertion
- 2 in/2 out and 1 in/2 out (2 in/1 out) of package types are available

PACKAGES

< G5CN >
< G6CN >

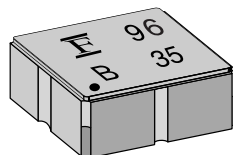

< G6CH >

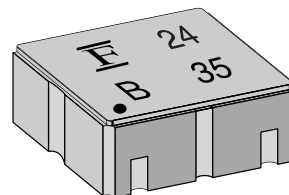

G5/G6 Series

■ PIN ASSIGNMENTS

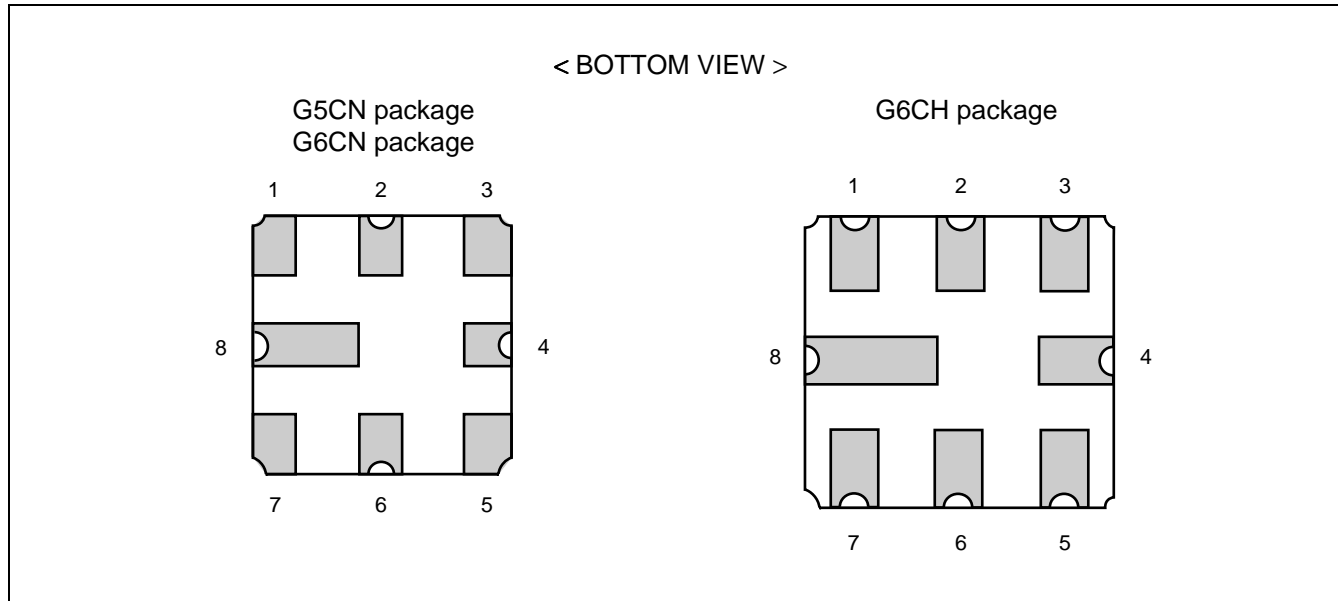

■ PIN DESCRIPTIONS

- 1 in/2 out type

Pin	Pin name	Description
1	IN	Input Pin (Common)
2	GND	Ground Pin
3	GND	Ground Pin
4	GND	Ground Pin
5	OUT	Filter 2 Output Pin
6	GND	Ground Pin
7	OUT	Filter 1 Output Pin
8	GND	Ground Pin

- 2 in/2 out type

Pin	Pin name	Description
1	IN	Filter 1 Input Pin
2	GND	Ground Pin
3	IN	Filter 2 Input Pin
4	GND	Ground Pin
5	OUT	Filter 2 Output Pin
6	GND	Ground Pin
7	OUT	Filter 1 Output Pin
8	GND	Ground Pin

INTERNAL BLOCK DIAGRAM

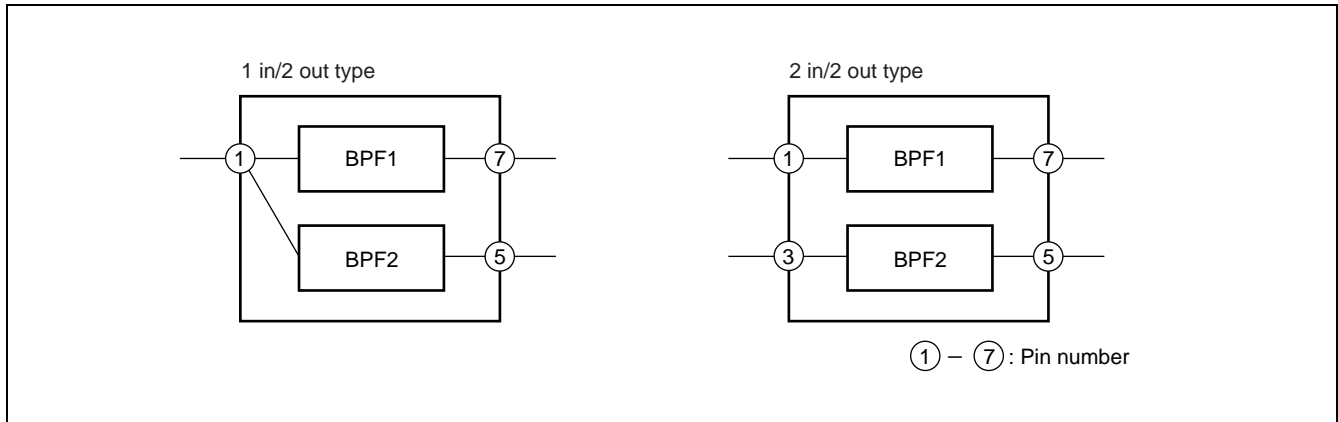

G5/G6 Series

■ ABSOLUTE MAXIMUM RATINGS

Parameter	Symbol	Rating		Unit
		Min.	Max.	
Operating temperature	Ta	-30	+85	°C
Storage temperature	Tstg	-40	+100	°C
Input power	P _{IN}	Depends on each design. See "■ ELECTRICAL CHARACTERISTICS".		
Input DC voltage	—	-5	+5	V

WARNING: Semiconductor devices can be permanently damaged by application of stress (voltage, current, temperature, etc.) in excess of absolute maximum ratings. Do not exceed these ratings.

■ RECOMMENDED OPERATING CONDITIONS

Parameter	Symbol	Value		Unit
		Min.	Max.	
Operating temperature	Ta	-30	+85	°C

WARNING: The recommended operating conditions are required in order to ensure the normal operation of the semiconductor device. All of the device's electrical characteristics are warranted when the device is operated within these ranges.

Always use semiconductor devices within their recommended operating condition ranges. Operation outside these ranges may adversely affect reliability and could result in device failure.

No warranty is made with respect to uses, operating conditions, or combinations not represented on the data sheet. Users considering application outside the listed conditions are advised to contact their FUJITSU representatives beforehand.

■ STANDARD DEVICES

No.	Part number	System	Frequency (MHz)	Part symbol	Input/Output	Remarks
1	FAR-G5CN-942M50-D296	PDC800 Tx	893 MHz to 898 MHz	96	1 in/ 2 out	3.0 mm × 3.0 mm
			925 MHz to 960 MHz			
2	FAR-G5CN-877M50-D292	PDC800 Rx	810 MHz to 843 MHz	92	1 in/ 2 out	3.0 mm × 3.0 mm
			870 MHz to 885 MHz			
3	FAR-G6CH-1G8800-L214	AMPS/TDMA/ CDMA + PCS Tx	824 MHz to 849 MHz	14	2 in/ 2 out	3.8 mm × 3.8 mm
			1850 MHz to 1910 MHz			
4	FAR-G6CH-1G9600-L215	AMPS/TDMA/ CDMA + PCS Rx	869 MHz to 894 MHz	15	2 in/ 2 out	3.8 mm × 3.8 mm
			1930 MHz to 1990 MHz			
5	FAR-G6CH-1G7475-L216	GSM + PCN Tx	890 MHz to 915 MHz	16	2 in/ 2 out	3.8 mm × 3.8 mm
			1710 MHz to 1785 MHz			
6	FAR-G6CH-1G8425-L217	GSM + PCN Rx	935 MHz to 960 MHz	17	2 in/ 2 out	3.8 mm × 3.8 mm
			1805 MHz to 1880 MHz			
7	FAR-G6CH-1G8425-L218	EGSM + PCN Rx	925 MHz to 960 MHz	18	2 in/ 2 out	3.8 mm × 3.8 mm Low insertion loss type
			1805 MHz to 1880 MHz			
8	FAR-G6CH-1G8425-L222	EGSM + PCN Rx	925 MHz to 960 MHz	22	2 in/ 2 out	3.8 mm × 3.8 mm High Aff. type
			1805 MHz to 1880 MHz			
9	FAR-G6CH-1G8425-L227B	EGSM + PCN Rx	925 MHz to 960 MHz	27	2 in/ 2 out	3.8 mm × 3.8 mm
			1805 MHz to 1880 MHz			
10	FAR-G6CH-1G9600-L228A	EGSM + PCS Rx	925 MHz to 960 MHz	28	2 in/ 2 out	3.8 mm × 3.8 mm
			1930 MHz to 1990 MHz			
11	FAR-G6CH-1G9600-L219	PCN + PCS Rx	1805 MHz to 1880 MHz	19	2 in/ 2 out	3.8 mm × 3.8 mm
			1930 MHz to 1990 MHz			
12	FAR-G6CN-1G8950-L233	PCS Tx Split	Low 1850 MHz to 1880 MHz	33	2 in/ 2 out	3.0 mm × 3.0 mm
			High 1880 MHz to 1910 MHz			
13	FAR-G6CH-1G9750-L230	PCS Rx Split	Low 1930 MHz to 1960 MHz	30	2 in/ 2 out	3.8 mm × 3.8 mm
			High 1960 MHz to 1990 MHz			

G5/G6 Series

■ ELECTRICAL CHARACTERISTICS AND TYPICAL FREQUENCY RESPONSE

1. PDC800 (Tx) 1 in/2 out

Part number : FAR-G5CN-942M50-D296

(Ta = -30 °C to +85 °C)

Parameter		Condition	Value			Unit	Remarks
			Min.	Typ.	Max.		
Filter 1	Insertion loss	893 MHz to 898 MHz	—	—	4.0	dB	-30 °C to +20 °C
		893 MHz to 898 MHz	—	2.7	3.5	dB	+20 °C to +30 °C
		893 MHz to 898 MHz	—	—	3.5	dB	+30 °C to +85 °C
	Pass-band ripple	893 MHz to 898 MHz	—	0.5	1.5	dB	
	Absolute stop-band attenuation	520 MHz to 570 MHz	40	48	—	dB	
		570 MHz to 640 MHz	35	40	—	dB	
		640 MHz to 750 MHz	30	33	—	dB	
		750 MHz to 810 MHz	24	28	—	dB	
		810 MHz to 870 MHz	15	21	—	dB	
		870 MHz to 885 MHz	11	—	—	dB	-30 °C to +20 °C
			11	18	—	dB	+20 °C to +30 °C
		7	—	—	dB	+30 °C to +85 °C	
	925 MHz to 1000 MHz	10	17	—	dB		
	1000 MHz to 1200 MHz	25	31	—	dB		
Pass-band VSWR (Return loss)	893 MHz to 898 MHz	— (6.0)	1.9 (10.2)	3.0 —	— (dB)		
Input power	893 MHz to 898 MHz	—	—	15	dBm		
Filter 2	Insertion loss	925 MHz to 960 MHz	—	2.9	4.0	dB	
	Pass-band ripple	925 MHz to 960 MHz	—	1.6	2.7	dB	
	Absolute stop-band attenuation	550 MHz to 650 MHz	38	42	—	dB	
		650 MHz to 700 MHz	40	51	—	dB	
		700 MHz to 780 MHz	32	36	—	dB	
		780 MHz to 885 MHz	23	33	—	dB	
		1000 MHz to 1050 MHz	14	17	—	dB	
	1050 MHz to 1200 MHz	30	35	—	dB		
Pass-band VSWR (Return loss)	925 MHz to 960 MHz	— (6.0)	1.9 (10.2)	3.0 —	— (dB)		
Input power	925 MHz to 960 MHz	—	—	15	dBm		

(Continued)

(Continued)

Part number : FAR-G5CN-942M50-D296

Filter 1 (Pass-band : 893 MHz to 898 MHz)

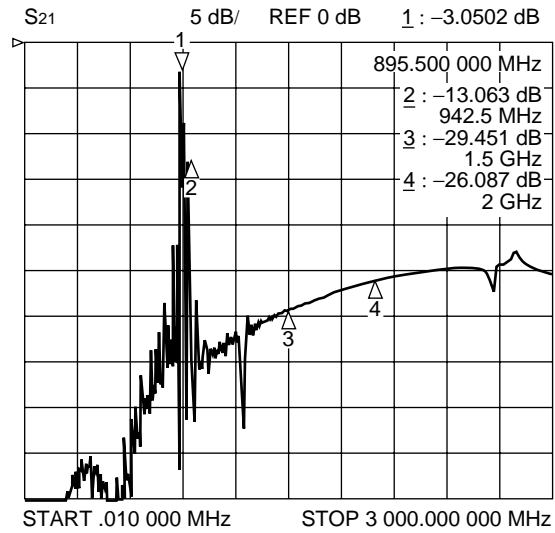
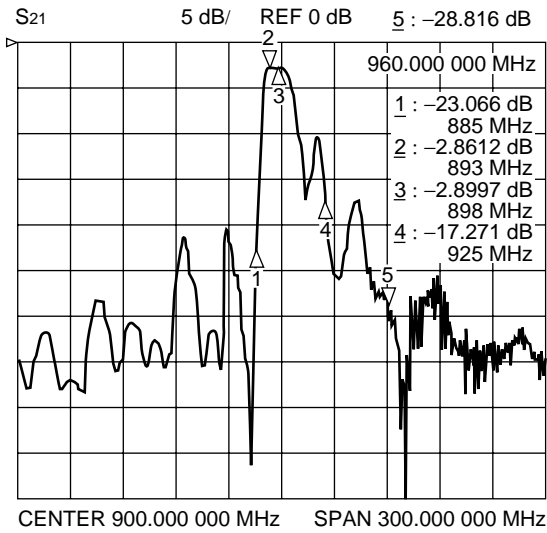

Filter 2 (Pass-band : 925 MHz to 960 MHz)

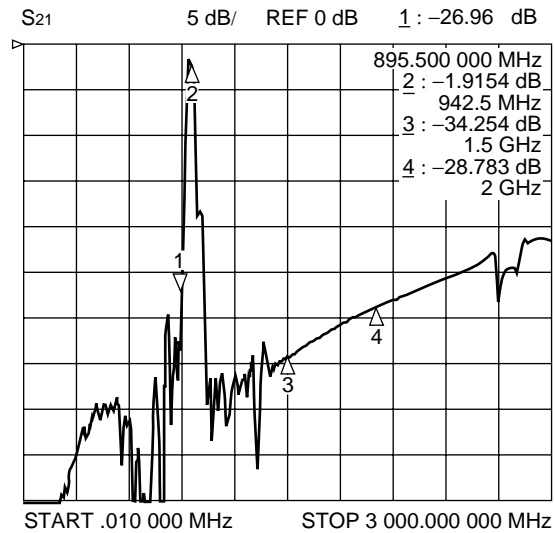
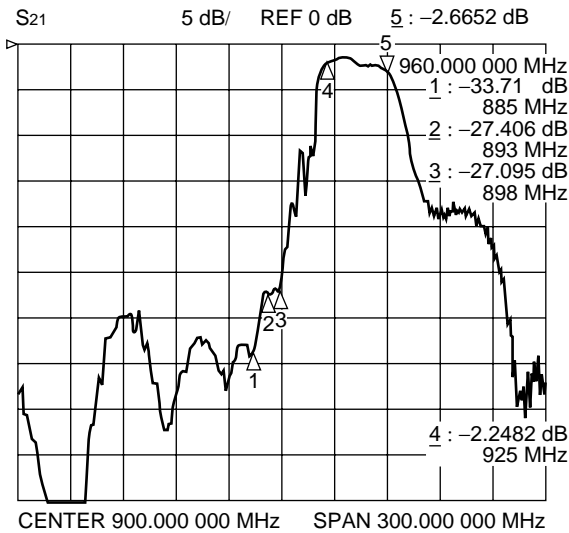

G5/G6 Series

2. PDC800 (Rx) 1 in/2 out Part number : FAR-G5CN-877M50-D292

(Ta = -30 °C to +85 °C)

Parameter	Condition	Value			Unit	Remarks	
		Min.	Typ.	Max.			
Filter 1	Insertion loss	810 MHz to 843 MHz	—	2.6	4.0	dB	
	Pass-band ripple	810 MHz to 843 MHz	—	0.8	2.2	dB	
	Absolute stop-band attenuation	550 MHz to 585 MHz	40	47	—	dB	
		585 MHz to 650 MHz	28	32	—	dB	
		650 MHz to 780 MHz	20	24	—	dB	
		865 MHz to 889 MHz	16	19	—	dB	
		889 MHz to 900 MHz	19	23	—	dB	
		900 MHz to 1070 MHz	20	27	—	dB	
	1070 MHz to 1110 MHz	30	33	—	dB		
Pass-band VSWR (Return loss)	810 MHz to 828 MHz	— (6.5)	2.1 (9.0)	2.8 —	— (dB)		
Input power	810 MHz to 828 MHz	—	—	15	dBm		
Filter 2	Insertion loss	870 MHz to 885 MHz	—	2.7	3.5	dB	
	Pass-band ripple	870 MHz to 885 MHz	—	0.2	1.0	dB	
	Absolute stop-band attenuation	610 MHz to 630 MHz	40	46	—	dB	
		630 MHz to 700 MHz	35	40	—	dB	
		700 MHz to 840 MHz	20	27	—	dB	
		925 MHz to 960 MHz	15	19	—	dB	
		960 MHz to 1130 MHz	30	37	—	dB	
		1130 MHz to 1145 MHz	32	35	—	dB	
	Pass-band VSWR (Return loss)	870 MHz to 885 MHz	— (7.4)	1.9 (10.2)	2.5 —	— (dB)	
Input power	870 MHz to 885 MHz	—	—	15	dBm		

(Continued)

(Continued)

Part number : FAR-G5CN-877M50-D292

Filter 1 (Pass-band : 810 MHz to 843 MHz)

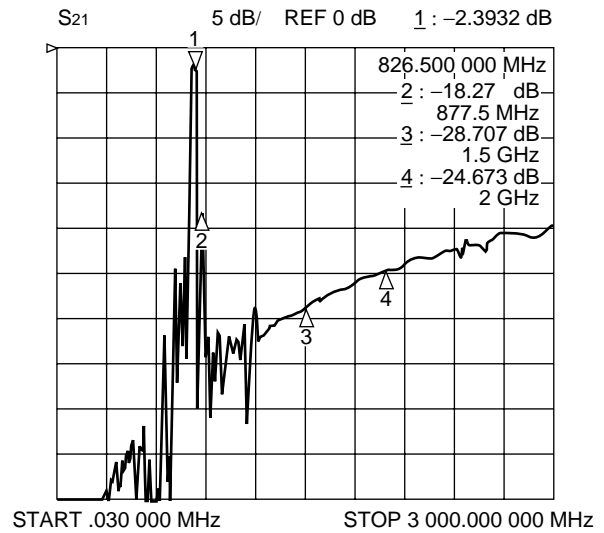
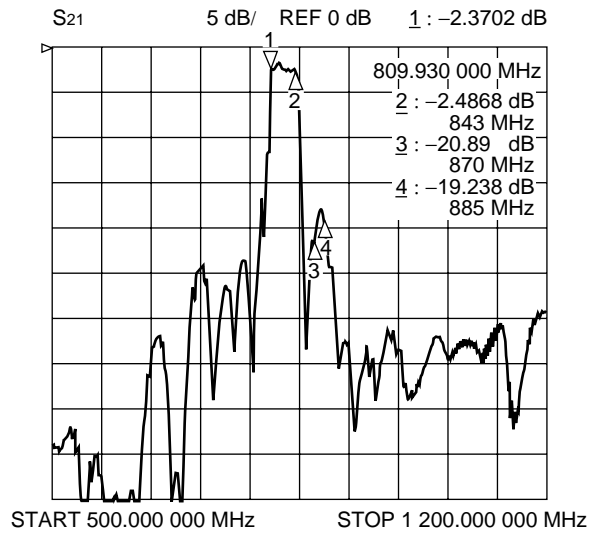

Filter 2 (Pass-band : 870 MHz to 885 MHz)

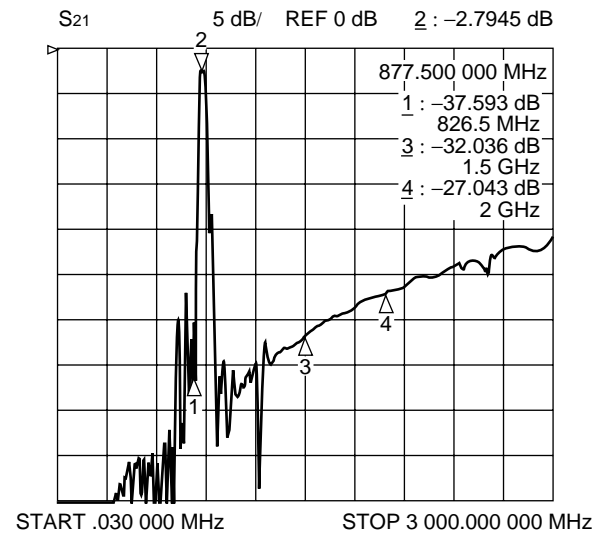
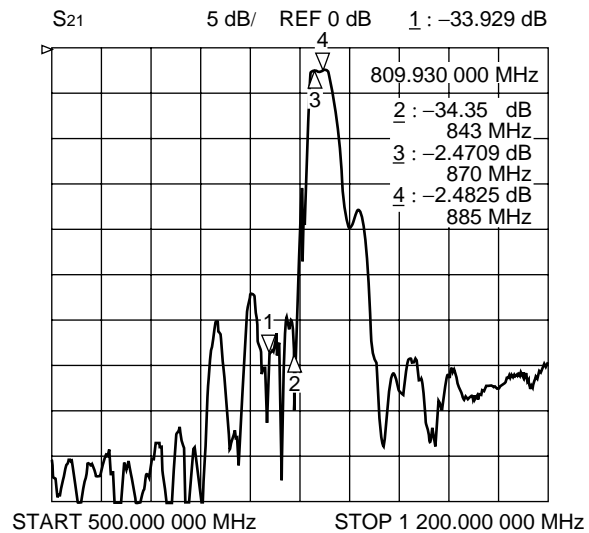

G5/G6 Series

3. AMPS/TDMA/CDMA Tx + PCS Tx (2 in/2 out)

Part number : FAR-G6CH-1G8800-L214

(Ta = -30 °C to +85 °C)

Parameter	Condition	Value			Unit	Remarks	
		Min.	Typ.	Max.			
Filter 1	Insertion loss	824 MHz to 849 MHz	—	2.9	3.6	dB	
	Pass-band ripple	824 MHz to 849 MHz	—	0.9	1.6	dB	
	Absolute stop-band attenuation	DC to 800 MHz	40	45	—	dB	
		869 MHz to 894 MHz	28	32	—	dB	
		1000 MHz to 1500 MHz	40	47	—	dB	
		1500 MHz to 2000 MHz	25	33	—	dB	
	Pass-band VSWR (Return loss)	824 MHz to 849 MHz	— (9.5)	1.6 (12.7)	2.0 —	— (dB)	
Input power	824 MHz to 849 MHz	—	—	15	dBm		
Filter 2	Insertion loss	1850 MHz to 1910 MHz	—	3.2	4.3	dB	
	Pass-band ripple	1850 MHz to 1910 MHz	—	1.6	2.7	dB	
	Absolute stop-band attenuation	DC to 1500 MHz	21	23	—	dB	
		1500 MHz to 1800 MHz	23	25	—	dB	
		1930 MHz to 1990 MHz	7	17	—	dB	
		2000 MHz to 2100 MHz	28	33	—	dB	
		2200 MHz to 3000 MHz	19	23	—	dB	
		3000 MHz to 4000 MHz	15	19	—	dB	
Pass-band VSWR (Return loss)	1850 MHz to 1910 MHz	— (8.1)	1.8 (10.9)	2.3 —	— (dB)		
Input power	1850 MHz to 1910 MHz	—	—	13	dBm		

(Continued)

(Continued)

Part number : FAR-G6CH-1G8800-L214

Filter 1 (Pass-band : 824 MHz to 849 MHz)

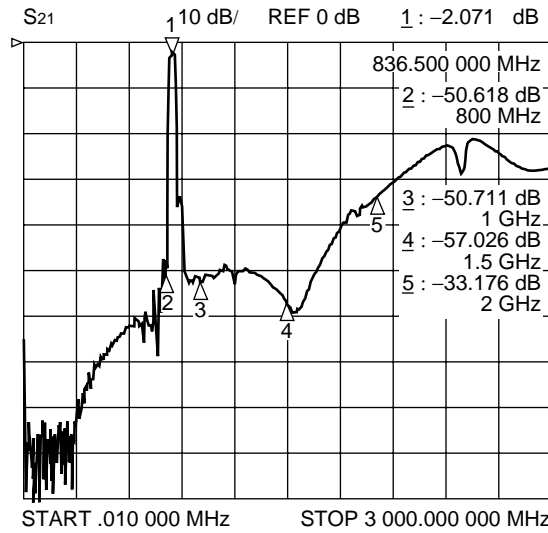
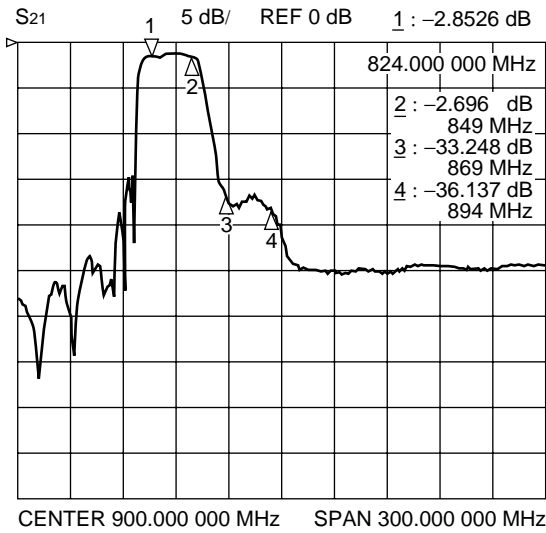

Filter 2 (Pass-band : 1850 MHz to 1910 MHz)

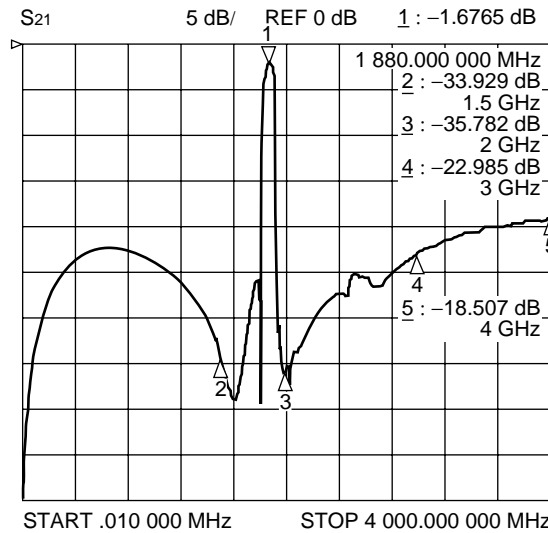
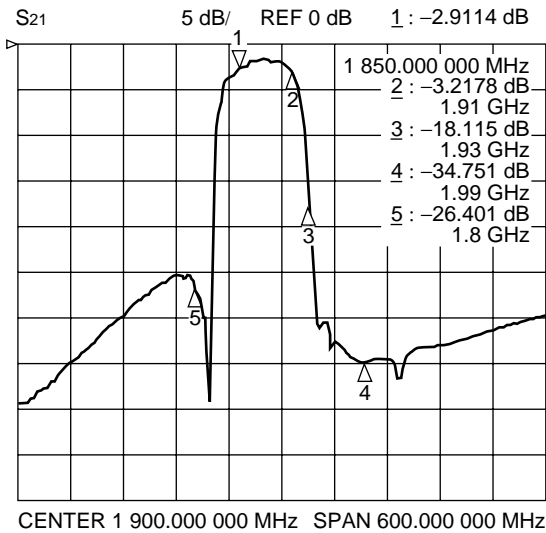

G5/G6 Series

4. AMPS/TDMA/CDMA Rx + PCS Rx (2 in/2 out) Part number : FAR-G6CH-1G9600-L215

(Ta = -30 °C to +85 °C)

Parameter	Condition	Value			Unit	Remarks	
		Min.	Typ.	Max.			
Filter 1	Insertion loss	869 MHz to 894 MHz	—	3.0	3.6	dB	
	Pass-band ripple	869 MHz to 894 MHz	—	1.0	1.6	dB	
	Absolute stop-band attenuation	DC to 800 MHz	42	50	—	dB	
		824 MHz to 849 MHz	30	45	—	dB	
		920 MHz to 1000 MHz	28	30	—	dB	
		1000 MHz to 1500 MHz	40	45	—	dB	
		1500 MHz to 2000 MHz	23	32	—	dB	
	Pass-band VSWR (Return loss)	869 MHz to 894 MHz	— (9.5)	1.5 (14.0)	2.0 —	— (dB)	
Input power	869 MHz to 894 MHz	—	—	15	dBm		
Filter 2	Insertion loss	1930 MHz to 1990 MHz	—	3.2	4.3	dB	
	Pass-band ripple	1930 MHz to 1990 MHz	—	1.5	2.6	dB	
	Absolute stop-band attenuation	DC to 1500 MHz	21	23	—	dB	
		1500 MHz to 1850 MHz	23	25	—	dB	
		1850 MHz to 1910 MHz	8	25	—	dB	
		2040 MHz to 2200 MHz	25	30	—	dB	
		2500 MHz to 3000 MHz	20	24	—	dB	
		3000 MHz to 4000 MHz	15	18	—	dB	
Pass-band VSWR (Return loss)	1930 MHz to 1990 MHz	— (8.1)	1.5 (14.0)	2.3 —	— (dB)		
Input power	1930 MHz to 1990 MHz	—	—	13	dBm		

(Continued)

(Continued)

Part number : FAR-G6CH-1G9600-L215

Filter 1 (Pass-band : 869 MHz to 894 MHz)

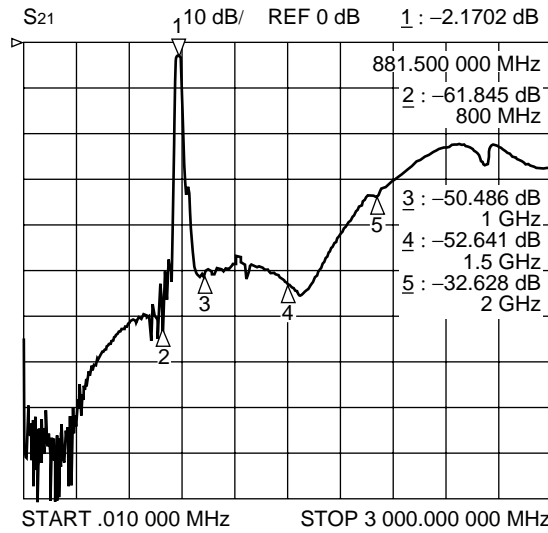
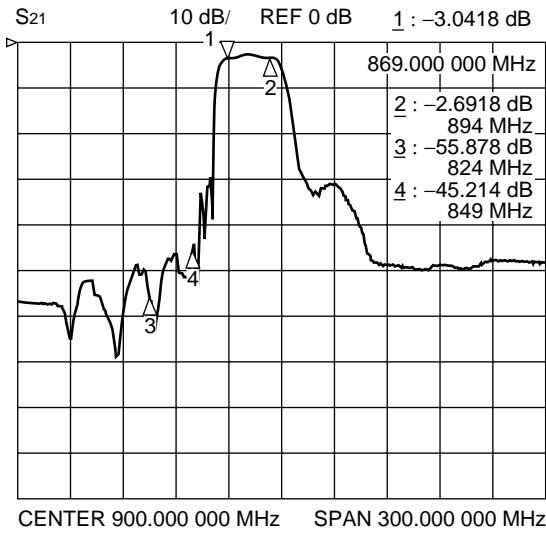

Filter 2 (Pass-band : 1930 MHz to 1960 MHz)

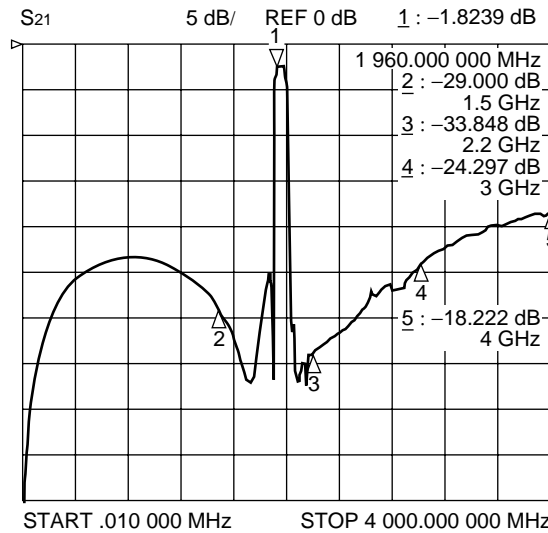
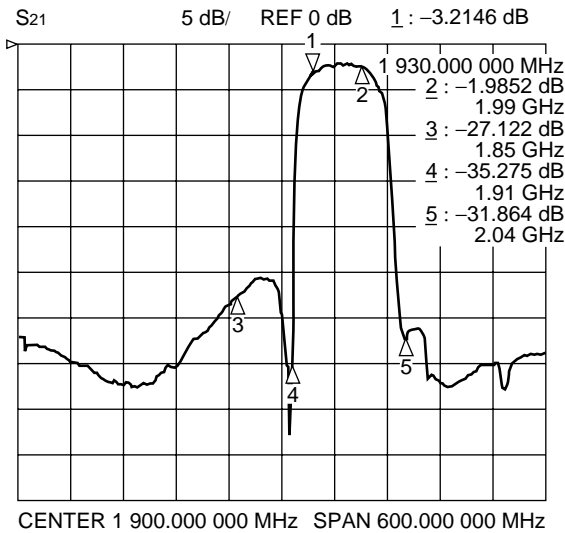

G5/G6 Series

5. GSM Tx + PCN Tx (2 in/2 out) Part number : FAR-G6CH-1G7475-L216

(Ta = -30 °C to +85 °C)

Parameter	Condition	Value			Unit	Remarks	
		Min.	Typ.	Max.			
Filter 1	Insertion loss	890 MHz to 915 MHz	—	3.1	3.6	dB	
	Pass-band ripple	890 MHz to 915 MHz	—	1.2	1.7	dB	
	Absolute stop-band attenuation	DC to 800 MHz	45	50	—	dB	
		800 MHz to 870 MHz	30	43	—	dB	
		935 MHz to 960 MHz	28	31	—	dB	
		1000 MHz to 1500 MHz	40	45	—	dB	
		1500 MHz to 2000 MHz	25	34	—	dB	
	Pass-band VSWR (Return loss)	890 MHz to 915 MHz	— (9.5)	1.5 (14.0)	2.0 —	— (dB)	
Input power	890 MHz to 915 MHz	—	—	15	dBm		
Filter 2	Insertion loss	1710 MHz to 1785 MHz	—	3.0	4.3	dB	
	Pass-band ripple	1710 MHz to 1785 MHz	—	1.6	2.9	dB	
	Absolute stop-band attenuation	DC to 1500 MHz	17	18	—	dB	
		1500 MHz to 1670 MHz	22	26	—	dB	
		1805 MHz to 1880 MHz	7	19	—	dB	
		1900 MHz to 2000 MHz	25	28	—	dB	
		2100 MHz to 3000 MHz	20	24	—	dB	
	3000 MHz to 3570 MHz	15	19	—	dB		
Pass-band VSWR (Return loss)	1710 MHz to 1785 MHz	— (7.7)	1.8 (10.9)	2.4 —	— (dB)		
Input power	1710 MHz to 1785 MHz	—	—	13	dBm		

(Continued)

(Continued)

Part number : FAR-G6CH-1G7475-L216

Filter 1 (Pass-band : 890 MHz to 915 MHz)

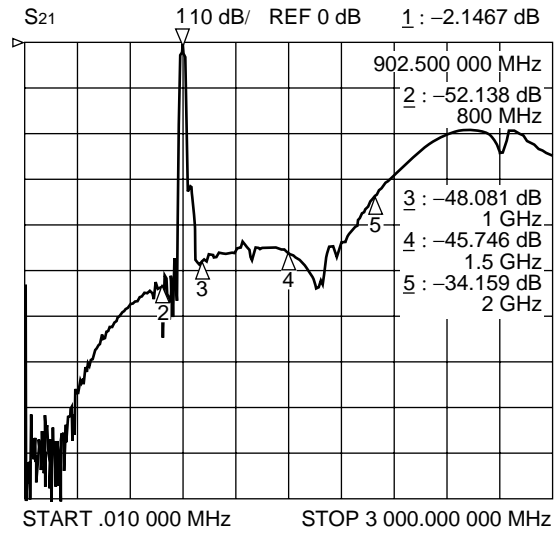
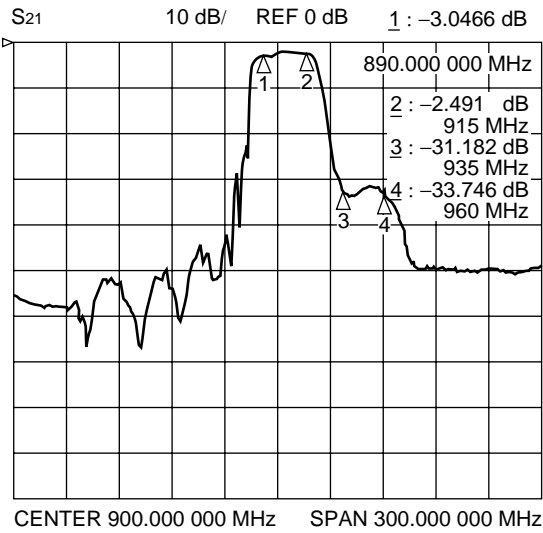

Filter 2 (Pass-band : 1710 MHz to 1785 MHz)

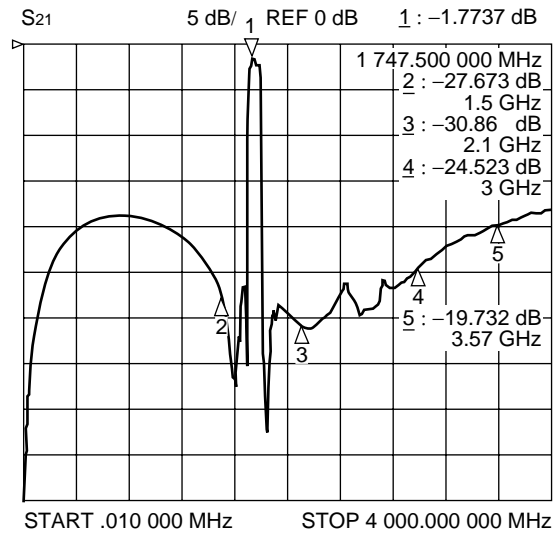
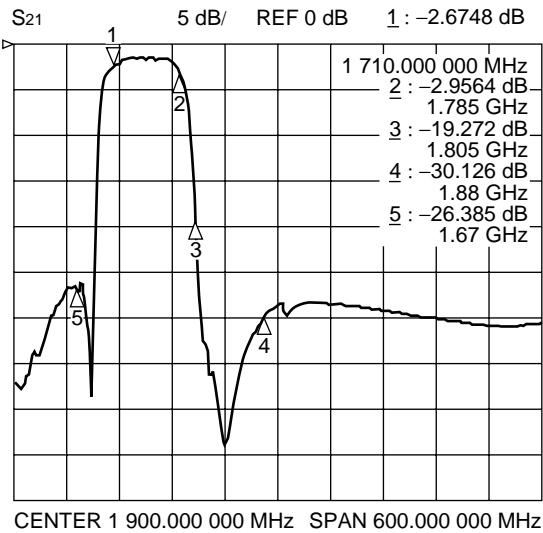

G5/G6 Series

6. GSM Rx + PCN Rx (2 in/2 out) Part number : FAR-G6CH-1G8425-L217

(Ta = -30 °C to +85 °C)

Parameter	Condition	Value			Unit	Remarks	
		Min.	Typ.	Max.			
Filter 1	Insertion loss	935 MHz to 960 MHz	—	3.1	3.5	dB	
	Pass-band ripple	935 MHz to 960 MHz	—	1.1	1.5	dB	
	Absolute stop-band attenuation	DC to 800 MHz	45	53	—	dB	
		890 MHz to 915 MHz	30	43	—	dB	
		980 MHz to 1030 MHz	25	30	—	dB	
		1100 MHz to 1500 MHz	40	45	—	dB	
		1500 MHz to 2000 MHz	25	36	—	dB	
	Pass-band VSWR (Return loss)	930 MHz to 960 MHz	— (9.5)	1.6 (12.7)	2.0 —	— (dB)	
Input power	930 MHz to 960 MHz	—	—	15	dBm		
Filter 2	Insertion loss	1805 MHz to 1880 MHz	—	2.8	4.0	dB	
	Pass-band ripple	1805 MHz to 1880 MHz	—	1.2	2.4	dB	
	Absolute stop-band attenuation	DC to 1300 MHz	17	18	—	dB	
		1355 MHz to 1430 MHz	17	20	—	dB	
		1500 MHz to 1710 MHz	20	22	—	dB	
		1710 MHz to 1785 MHz	11	25	—	dB	
		1920 MHz to 1980 MHz	20	30	—	dB	
		2000 MHz to 3000 MHz	22	25	—	dB	
		3000 MHz to 3760 MHz	15	18	—	dB	
Pass-band VSWR (Return loss)	1805 MHz to 1880 MHz	— (7.7)	2.0 (9.5)	2.4 —	— (dB)		
Input power	1805 MHz to 1880 MHz	—	—	13	dBm		

(Continued)

(Continued)

Part number : FAR-G6CH-1G8425-L217

Filter 1 (Pass-band : 935 MHz to 960 MHz)

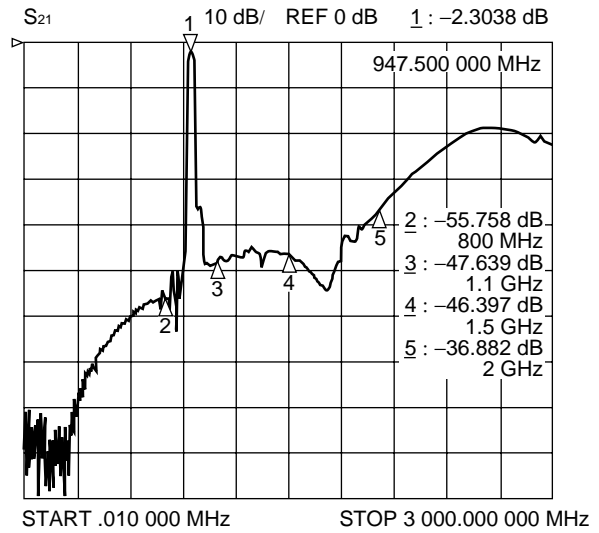
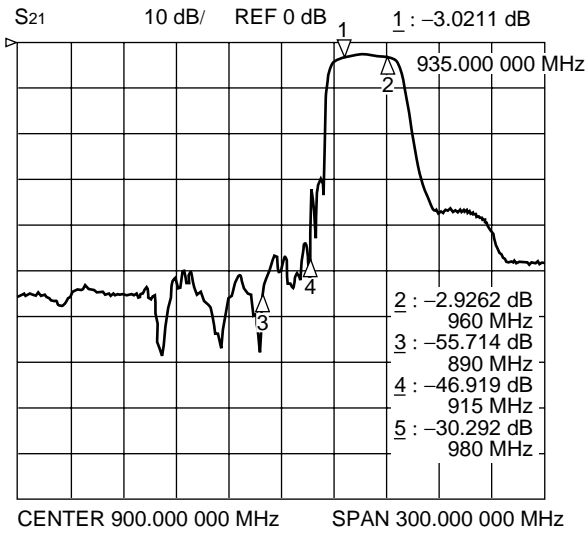

Filter 2 (Pass-band : 1805 MHz to 1880 MHz)

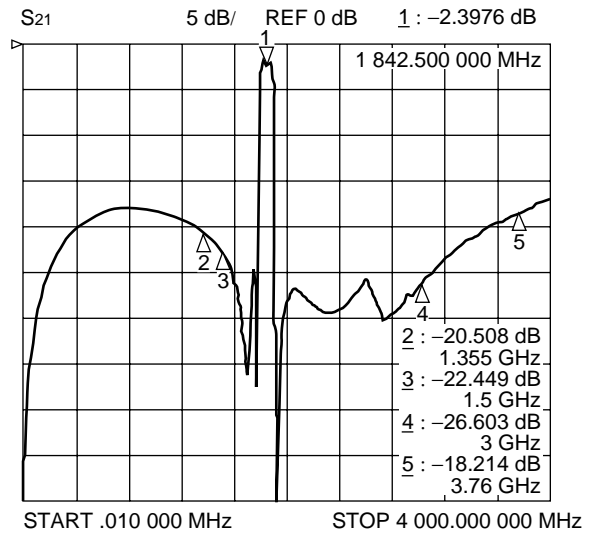
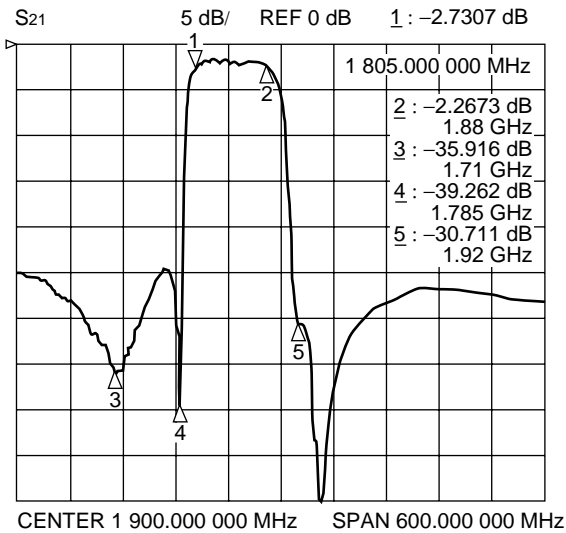

G5/G6 Series

7. EGSM Rx + PCN Rx (2 in/2 out) Part number : FAR-G6CH-1G8425-L218

(Ta = -30 °C to +85 °C)

Parameter	Condition	Value			Unit	Remarks	
		Min.	Typ.	Max.			
Filter 1	Insertion loss	925 MHz to 960 MHz	—	—	2.5	dB	+20 °C to +30 °C
			—	2.2	3.0	dB	-30 °C to +85 °C
	Pass-band ripple	925 MHz to 960 MHz	—	0.8	1.6	dB	
	Absolute stop-band attenuation	DC to 880 MHz	16	18	—	dB	
			10	—	—	dB	+20 °C to +30 °C
		880 MHz to 915 MHz	5	17	—	dB	-30 °C to +85 °C
			13	22	—	dB	
		1375 MHz to 1410 MHz	20	24	—	dB	
		1850 MHz to 1920 MHz	25	32	—	dB	
	2775 MHz to 2880 MHz	15	18	—	dB		
Pass-band VSWR (Return loss)	925 MHz to 960 MHz	— (7.4)	2.1 (9.0)	2.5 —	— (dB)		
Input power	925 MHz to 960 MHz	—	—	23	dBm		
Filter 2	Insertion loss	1805 MHz to 1880 MHz	—	—	3.2	dB	+20 °C to +30 °C
			—	2.7	3.7	dB	-30 °C to +85 °C
	Pass-band ripple	1805 MHz to 1880 MHz	—	1.1	2.1	dB	
	Absolute stop-band attenuation	DC to 1300 MHz	17	18	—	dB	
			18	20	—	dB	
		1500 MHz to 1710 MHz	20	22	—	dB	
			17	—	—	dB	+20 °C to +30 °C
		1710 MHz to 1785 MHz	8	25	—	dB	-30 °C to +85 °C
			15	29	—	dB	
		3610 MHz to 3760 MHz	15	17	—	dB	
5415 MHz to 5640 MHz	12	17	—	dB			
Pass-band VSWR (Return loss)	1805 MHz to 1880 MHz	— (7.7)	2.0 (9.5)	2.4 —	— (dB)		
Input power	1805 MHz to 1880 MHz	—	—	13	dBm		

(Continued)

(Continued)

Part number : FAR-G6CH-1G8425-L218

Filter 1 (Pass-band : 925 MHz to 960 MHz)

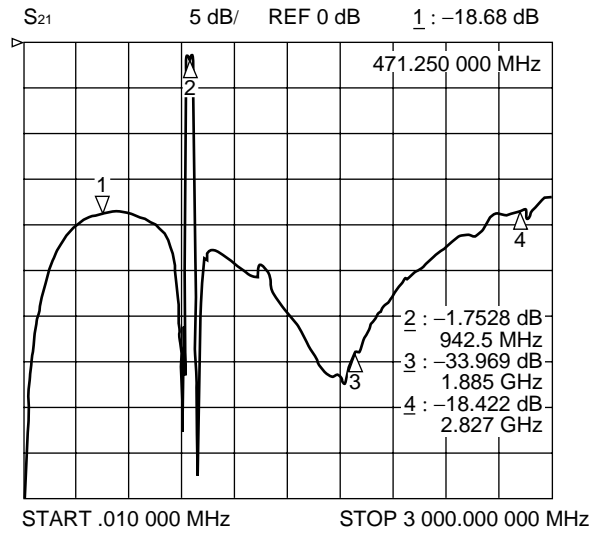
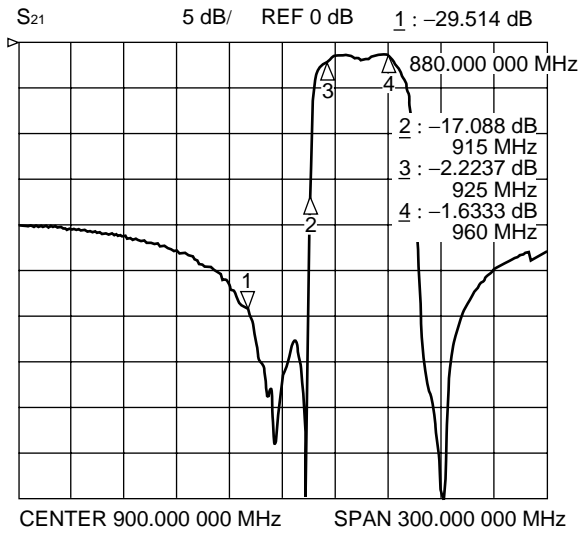

Filter 2 (Pass-band : 1805 MHz to 1880 MHz)

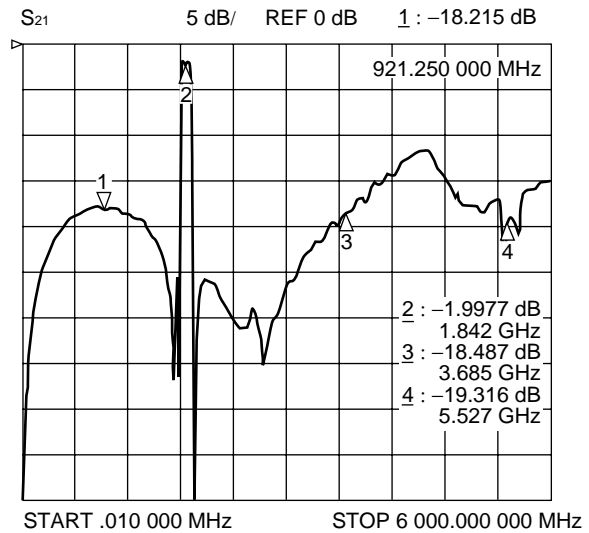
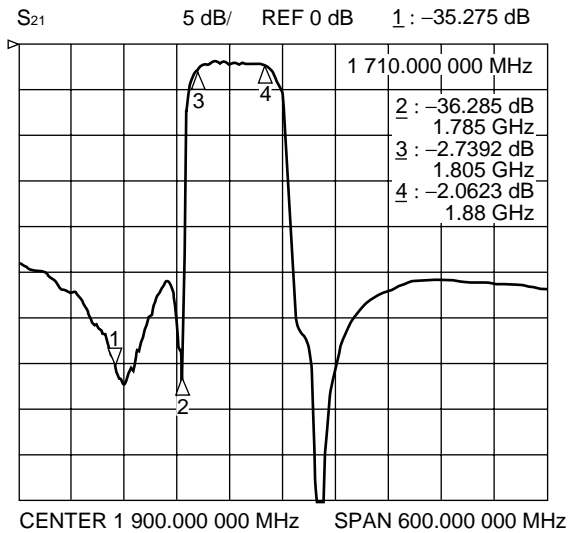

G5/G6 Series

8. EGSM Rx + PCN Rx (2 in/2 out) Part number : FAR-G6CH-1G8425-L222

(Ta = -30 °C to +85 °C)

Parameter	Condition	Value			Unit	Remarks	
		Min.	Typ.	Max.			
Filter 1	Insertion loss	925 MHz to 960 MHz	—	3.6	4.8	dB	
	Pass-band ripple	925 MHz to 960 MHz	—	1.6	2.8	dB	
	Absolute stop-band attenuation	DC to 800 MHz	40	50	—	dB	
		880 MHz to 915 MHz	15	22	—	dB	
		980 MHz to 1030 MHz	25	31	—	dB	
		1375 MHz to 1410 MHz	40	46	—	dB	
		1850 MHz to 1920 MHz	30	44	—	dB	
	Pass-band VSWR (Return loss)	925 MHz to 960 MHz	— (6.5)	2.3 (8.1)	2.8 —	— (dB)	
Input power	925 MHz to 960 MHz	—	—	15	dBm		
Filter 2	Insertion loss	1805 MHz to 1880 MHz	—	3.4	4.5	dB	
	Pass-band ripple	1805 MHz to 1880 MHz	—	1.8	2.9	dB	
	Absolute stop-band attenuation	DC to 1300 MHz	20	22	—	dB	
		1355 MHz to 1430 MHz	21	23	—	dB	
		1500 MHz to 1710 MHz	22	25	—	dB	
		1710 MHz to 1785 MHz	10	23	—	dB	
		1920 MHz to 1980 MHz	25	34	—	dB	
	3610 MHz to 3760 MHz	20	36	—	dB		
Pass-band VSWR (Return loss)	1805 MHz to 1880 MHz	— (6.5)	2.3 (8.1)	2.8 —	— (dB)		
Input power	1805 MHz to 1880 MHz	—	—	13	dBm		

(Continued)

(Continued)

Part number : FAR-G6CH-1G8425-L222

Filter 1 (Pass-band : 925 MHz to 960 MHz)

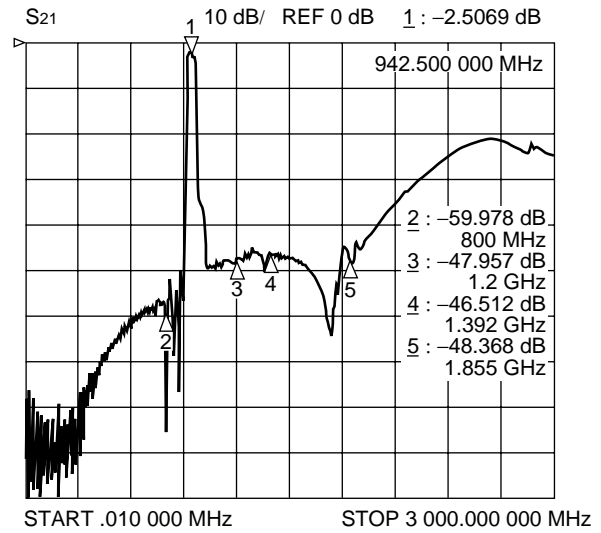
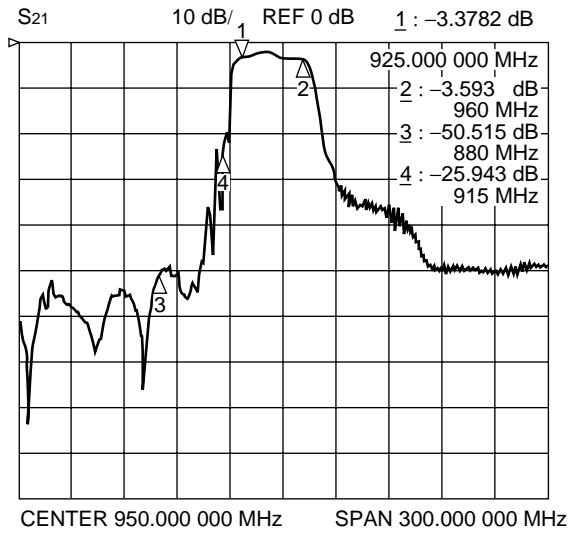

Filter 2 (Pass-band : 1805 MHz to 1880 MHz)

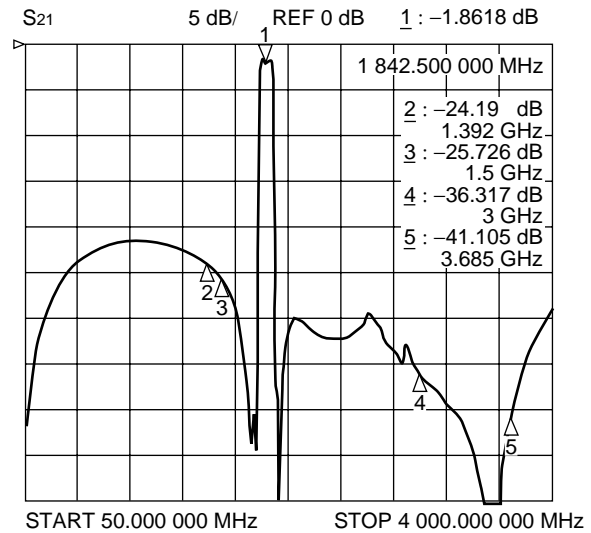
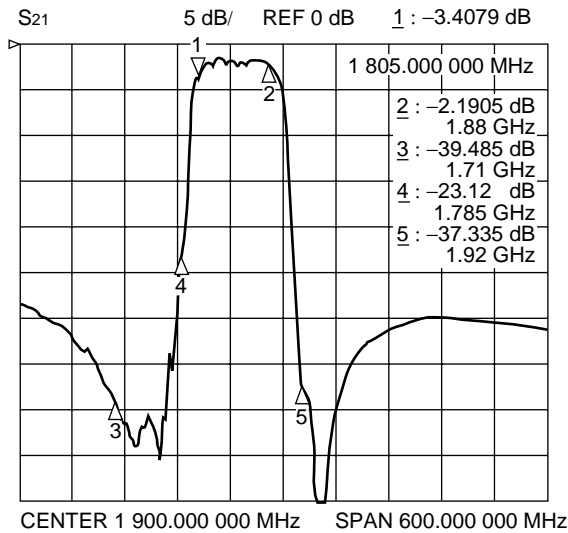

G5/G6 Series

9. EGSM Rx + PCN Rx (2 in/2 out) Part number : FAR-G6CH-1G8425-L227B

(Ta = -30 °C to +85 °C)

Parameter	Condition	Value			Unit	Remarks	
		Min.	Typ.	Max.			
Filter 1	Insertion loss	925 MHz to 960 MHz	—	—	3.0	dB	+20 °C to +30 °C
			—	2.7	3.7	dB	-30 °C to +85 °C
	Pass-band ripple	925 MHz to 960 MHz	—	1.1	2.1	dB	
	Absolute stop-band attenuation	DC to 880 MHz	22	23	—	dB	
		880 MHz to 905 MHz	28	32	—	dB	
		905 MHz to 915 MHz	11	32	—	dB	-30 °C to +30 °C
			7	—	—	dB	+30 °C to +85 °C
		980 MHz to 1200 MHz	20	30	—	dB	
		1375 MHz to 1410 MHz	30	38	—	dB	
	1850 MHz to 1920 MHz	20	26	—	dB		
Pass-band VSWR (Return loss)	925 MHz to 960 MHz	— (7.7)	1.9 (10.2)	2.4 —	— (dB)		
Input power	925 MHz to 960 MHz	—	—	23	dBm		
Filter 2	Insertion loss	1805 MHz to 1880 MHz	—	—	3.5	dB	+20 °C to +30 °C
			—	2.8	3.9	dB	-30 °C to +85 °C
	Pass-band ripple	1805 MHz to 1880 MHz	—	1.3	2.4	dB	
	Absolute stop-band attenuation	DC to 1300 MHz	17	18	—	dB	
		1355 MHz to 1430 MHz	17	19	—	dB	
		1600 MHz to 1710 MHz	20	22	—	dB	
		1710 MHz to 1785 MHz	20	25	—	dB	-30 °C to +30 °C
			10	—	—	dB	+30 °C to +85 °C
		1920 MHz to 1980 MHz	20	29	—	dB	
	3610 MHz to 3760 MHz	15	19	—	dB		
Pass-band VSWR (Return loss)	1805 MHz to 1880 MHz	— (7.7)	1.9 (10.2)	2.4 —	— (dB)		
Input power	1805 MHz to 1880 MHz	—	—	13	dBm		

(Continued)

(Continued)

Part number : FAR-G6CH-1G8425-L227B

Filter 1 (Pass-band : 925 MHz to 960 MHz)

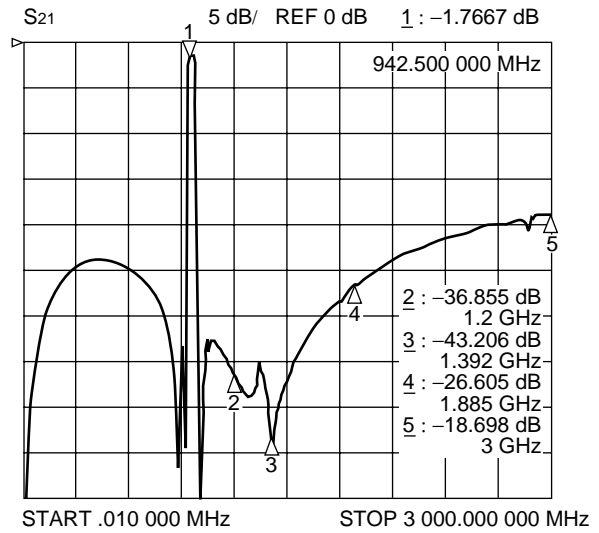
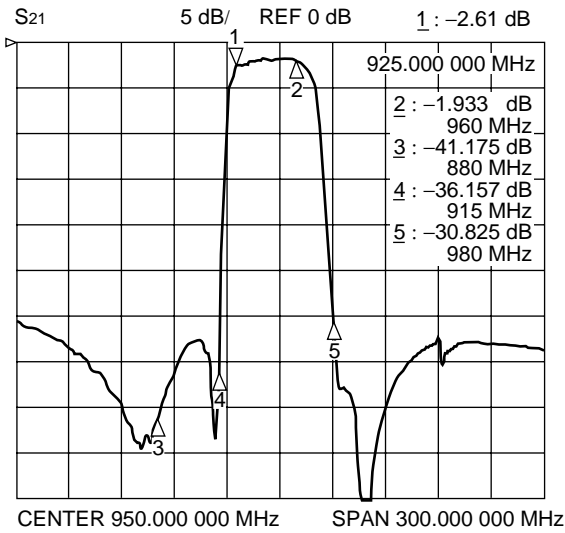

Filter 2 (Pass-band : 1805 MHz to 1880 MHz)

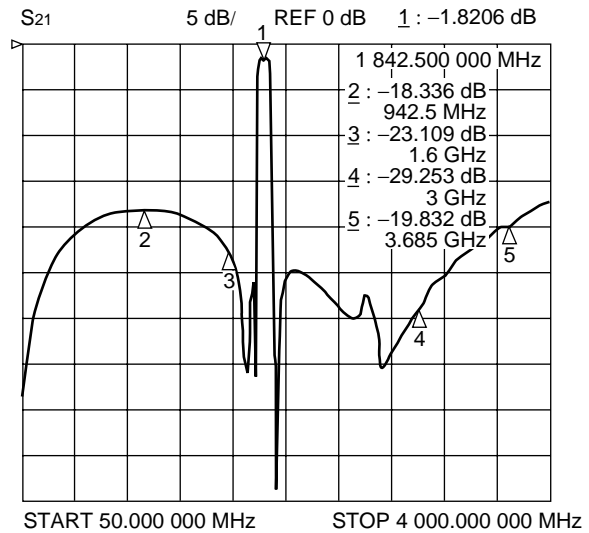
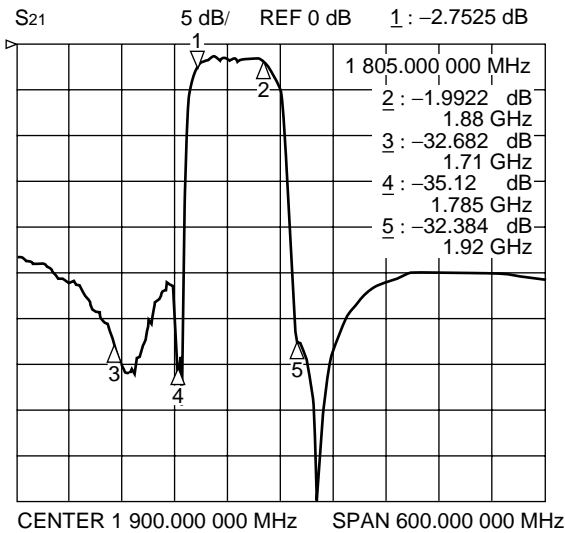

G5/G6 Series

10. EGSM Rx + PCN Rx (2 in/2 out) Part number : FAR-G6CH-1G9600-L228A

(Ta = -30 °C to +85 °C)

Parameter	Condition	Value			Unit	Remarks	
		Min.	Typ.	Max.			
Filter 1	Insertion loss	925 MHz to 960 MHz	—	—	3.0	dB	+20 °C to +30 °C
			—	2.7	3.7	dB	-30 °C to +85 °C
	Pass-band ripple	925 MHz to 960 MHz	—	1.1	2.1	dB	
	Absolute stop-band attenuation	DC to 880 MHz	22	23	—	dB	
		880 MHz to 905 MHz	28	32	—	dB	
		905 MHz to 915 MHz	11	32	—	dB	-30 °C to +30 °C
			7	—	—	dB	+30 °C to +85 °C
		980 MHz to 1200 MHz	20	—	—	dB	-30 °C to +20 °C
			25	32	—	dB	+20 °C to +85 °C
	1375 MHz to 1410 MHz	30	38	—	dB		
1850 MHz to 1920 MHz	20	26	—	dB			
Pass-band VSWR (Return loss)	925 MHz to 960 MHz	— (7.7)	1.9 (10.2)	2.4 —	— (dB)		
Input power	925 MHz to 960 MHz	—	—	23	dBm		
Filter 2	Insertion loss	1930 MHz to 1990 MHz	—	—	3.9	dB	+20 °C to +30 °C
			—	3.5	4.2	dB	-30 °C to +85 °C
	Pass-band ripple	1930 MHz to 1990 MHz	—	1.9	2.6	dB	
	Absolute stop-band attenuation	DC to 1850 MHz	20	22	—	dB	
		1850 MHz to 1910 MHz	7	10	—	dB	-30 °C to +30 °C
			5	—	—	dB	+30 °C to +85 °C
		2010 MHz to 2100 MHz	5	—	—	dB	-30 °C to +20 °C
			6	10	—	dB	+20 °C to +85 °C
		2500 MHz to 2700 MHz	20	25	—	dB	
	3000 MHz to 4000 MHz	15	18	—	dB		
Pass-band VSWR (Return loss)	1930 MHz to 1990 MHz	— (7.0)	2.1 (9.0)	2.6 —	— (dB)		
Input power	1930 MHz to 1990 MHz	—	—	13	dBm		

(Continued)

(Continued)

Part number : FAR-G6CH-1G9600-L228A

Filter 1 (Pass-band : 925 MHz to 960 MHz)

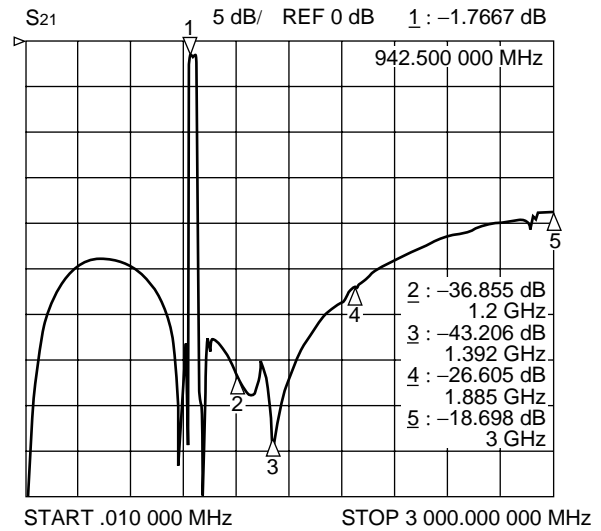
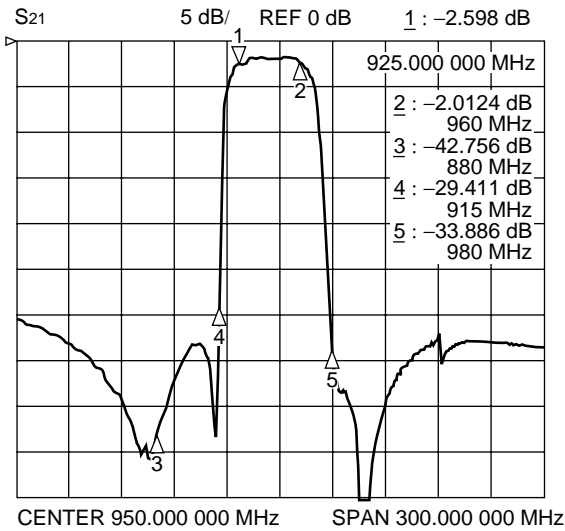

Filter 2 (Pass-band : 1930 MHz to 1990 MHz)

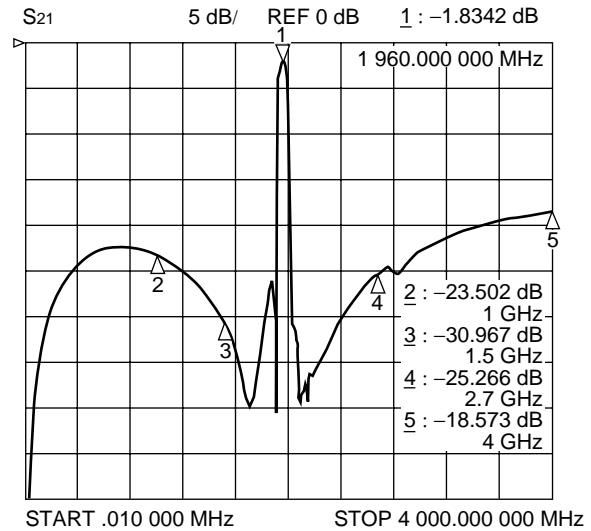
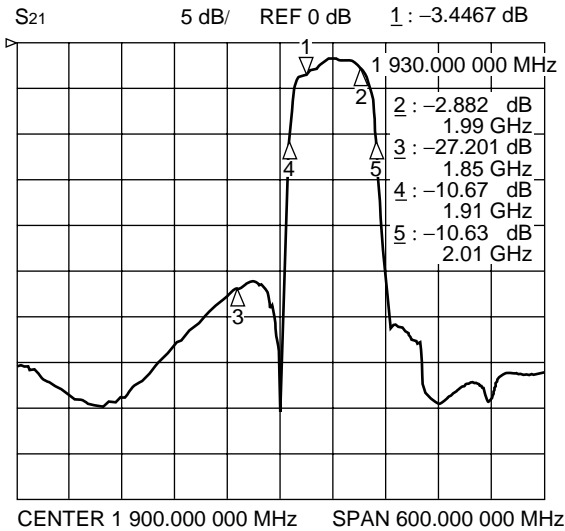

G5/G6 Series

11. PCN Rx + PCS Rx (2 in/2 out) Part number : FAR-G6CH-1G9600-L219

(Ta = -30 °C to +85 °C)

Parameter	Condition	Value			Unit	Remarks	
		Min.	Typ.	Max.			
Filter 1	Insertion loss	1805 MHz to 1880 MHz	—	3.1	4.0	dB	
	Pass-band ripple	1805 MHz to 1880 MHz	—	1.4	2.3	dB	
	Absolute stop-band attenuation	DC to 1500 MHz	17	18	—	dB	
		1600 MHz to 1710 MHz	22	25	—	dB	
		1710 MHz to 1785 MHz	10	24	—	dB	
		1920 MHz to 1980 MHz	20	30	—	dB	
		2000 MHz to 2400 MHz	25	27	—	dB	
		3610 MHz to 3760 MHz	16	18	—	dB	
	5415 MHz to 5640 MHz	14	16	—	dB		
Pass-band VSWR (Return loss)	1805 MHz to 1880 MHz	— (7.7)	2.0 (9.5)	2.4 —	— (dB)		
Input power	1805 MHz to 1880 MHz	—	—	13	dBm		
Filter 2	Insertion loss	1930 MHz to 1990 MHz	—	3.1	4.3	dB	
	Pass-band ripple	1930 MHz to 1990 MHz	—	1.2	2.4	dB	
	Absolute stop-band attenuation	DC to 1500 MHz	21	23	—	dB	
		1500 MHz to 1850 MHz	22	25	—	dB	
		1850 MHz to 1910 MHz	8	23	—	dB	
		2040 MHz to 2200 MHz	25	28	—	dB	
		2500 MHz to 3000 MHz	19	21	—	dB	
		3860 MHz to 3980 MHz	16	19	—	dB	
	5790 MHz to 5970 MHz	8	11	—	dB		
Pass-band VSWR (Return loss)	1930 MHz to 1990 MHz	— (8.1)	1.5 (14.0)	2.3 —	— (dB)		
Input power	1930 MHz to 1990 MHz	—	—	13	dBm		

(Continued)

(Continued)

Part number : FAR-G6CH-1G9600-L219

Filter 1 (Pass-band : 1805 MHz to 1880 MHz)

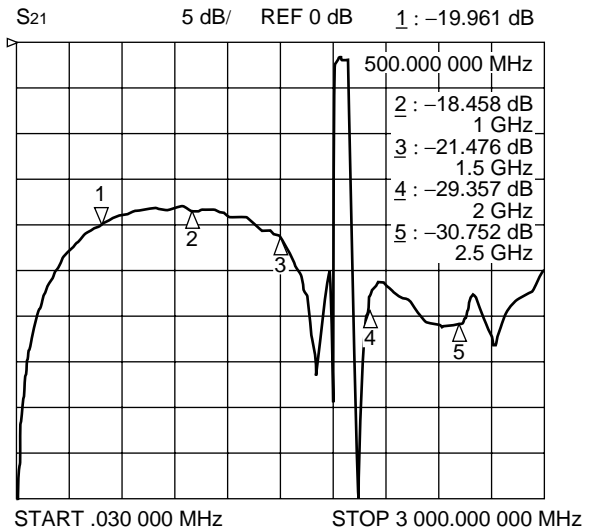
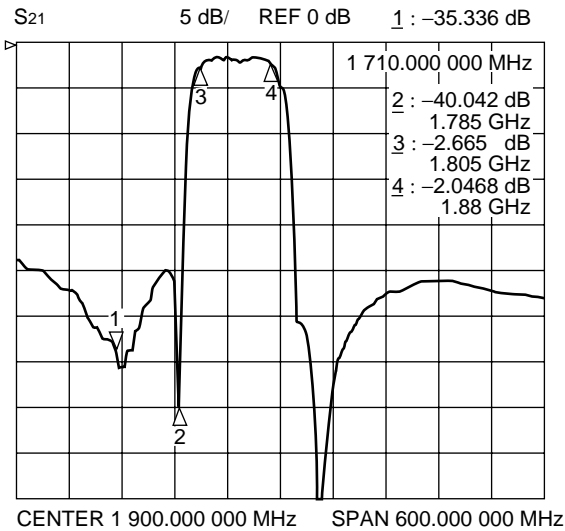

Filter 2 (Pass-band : 1930 MHz to 1990 MHz)

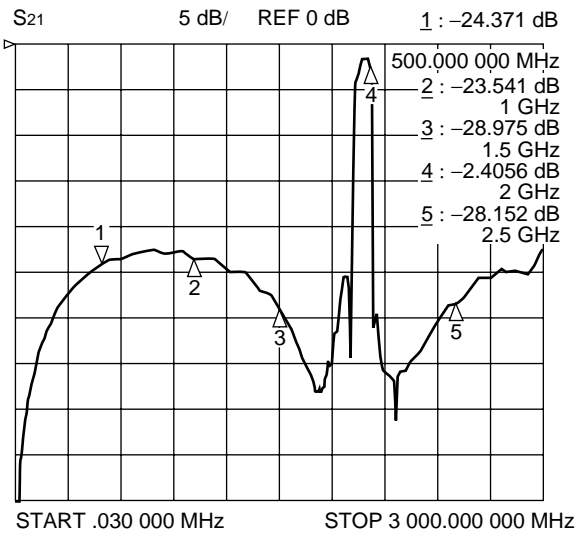
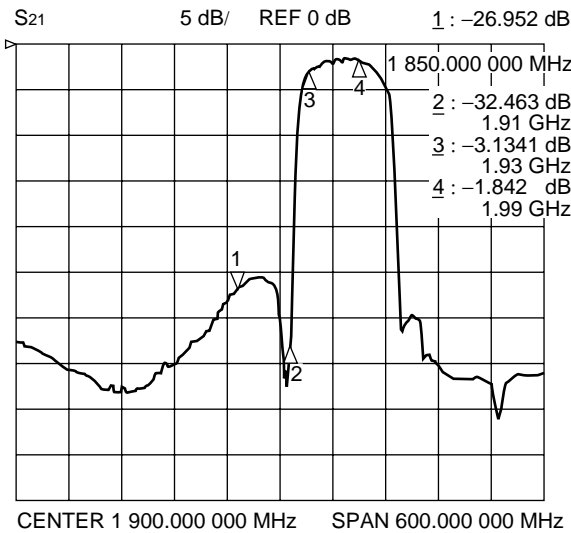

G5/G6 Series

12. PCS Tx split band (low band + high band dual) (2 in/2 out)

Part number : FAR-G6CN-1G8950-L233

(Ta = -30 °C to +85 °C)

Parameter	Condition	Value			Unit	Remarks	
		Min.	Typ.	Max.			
Filter 1	Insertion loss	1850 MHz to 1880 MHz	—	2.1	3.2	dB	
	Pass-band ripple	1850 MHz to 1880 MHz	—	0.4	1.5	dB	
	Absolute stop-band attenuation	DC to 1700 MHz	20	23	—	dB	
		1700 MHz to 1760 MHz	28	38	—	dB	
		1930 MHz to 1960 MHz	30	38	—	dB	
		2000 MHz to 2100 MHz	30	35	—	dB	
		2100 MHz to 3000 MHz	25	35	—	dB	
	Pass-band VSWR (Return loss)	1850 MHz to 1880 MHz	— (8.5)	1.4 (15.6)	2.2 —	— (dB)	
Input power	1850 MHz to 1880 MHz	—	—	13	dBm		
Filter 2	Insertion loss	1880 MHz to 1910 MHz	—	2.4	3.2	dB	
	Pass-band ripple	1880 MHz to 1910 MHz	—	0.6	1.5	dB	
	Absolute stop-band attenuation	DC to 1700 MHz	21	24	—	dB	
		1700 MHz to 1760 MHz	28	37	—	dB	
		1800 MHz to 1830 MHz	15	26	—	dB	
		1960 MHz to 1990 MHz	30	37	—	dB	
		2000 MHz to 2100 MHz	30	38	—	dB	
	2100 MHz to 3000 MHz	25	32	—	dB		
Pass-band VSWR (Return loss)	1880 MHz to 1910 MHz	— (8.5)	1.5 (14.0)	2.2 —	— (dB)		
Input power	1880 MHz to 1910 MHz	—	—	13	dBm		

(Continued)

(Continued)

Part number : FAR-G6CN-1G8950-L233

Filter 1 (Pass-band : 1850 MHz to 1880 MHz)

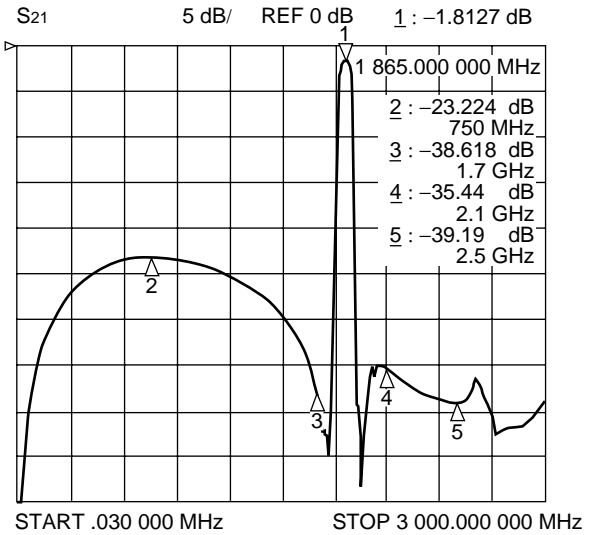
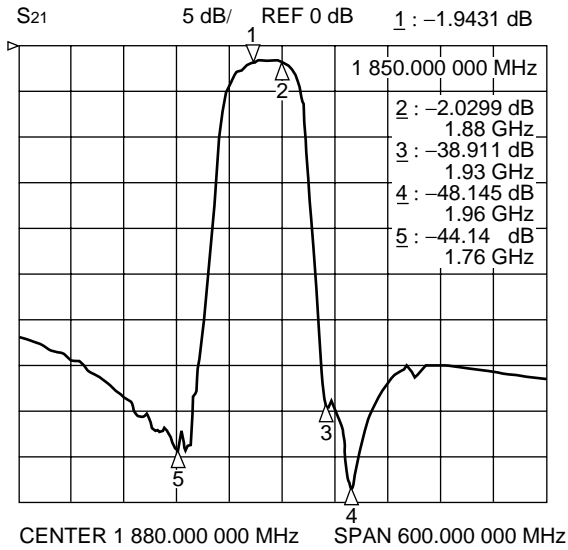

Filter 2 (Pass-band : 1880 MHz to 1910 MHz)

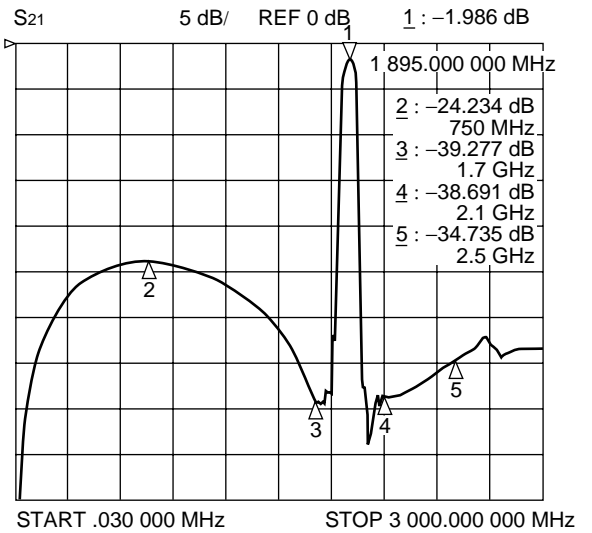
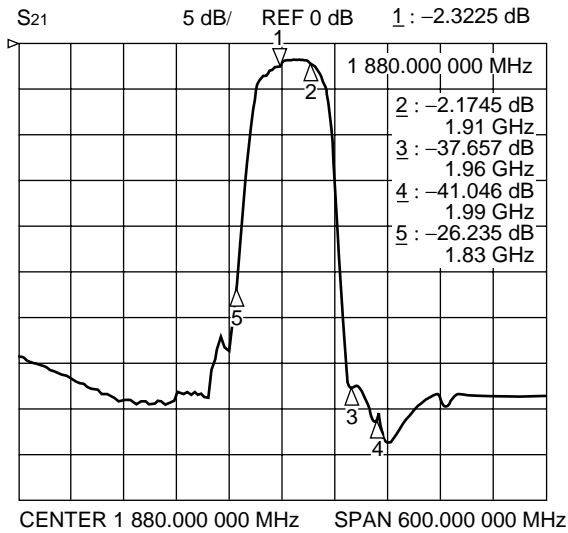

G5/G6 Series

13. PCS Rx split band (low band + high band dual) (2 in/2 out) Part number : FAR-G6CH-1G9750-L230

(Ta = -30 °C to +85 °C)

Parameter	Condition	Value			Unit	Remarks	
		Min.	Typ.	Max.			
Filter 1	Insertion loss	1930 MHz to 1960 MHz	—	2.4	3.2	dB	
	Pass-band ripple	1930 MHz to 1960 MHz	—	0.6	1.4	dB	
	Absolute stop-band attenuation	DC to 1850 MHz	20	21	—	dB	
		1850 MHz to 1880 MHz	30	36	—	dB	
		2040 MHz to 2070 MHz	20	30	—	dB	
		2500 MHz to 3000 MHz	20	32	—	dB	
	Pass-band VSWR (Return loss)	1930 MHz to 1960 MHz	— (9.0)	1.7 (11.7)	2.1 —	— (dB)	
Input power	1930 MHz to 1960 MHz	—	—	13	dBm		
Filter 2	Insertion loss	1960 MHz to 1990 MHz	—	2.3	3.2	dB	
	Pass-band ripple	1960 MHz to 1990 MHz	—	0.5	1.4	dB	
	Absolute stop-band attenuation	DC to 1880 MHz	20	21	—	dB	
		1880 MHz to 1910 MHz	30	40	—	dB	
		2070 MHz to 2100 MHz	20	31	—	dB	
		2500 MHz to 3000 MHz	20	31	—	dB	
	Pass-band VSWR (Return loss)	1960 MHz to 1990 MHz	— (9.0)	1.7 (11.7)	2.1 —	— (dB)	
Input power	1960 MHz to 1990 MHz	—	—	13	dBm		

(Continued)

(Continued)

Part number : FAR-G6CH-1G9750-L230

Filter 1 (Pass-band : 1930 MHz to 1960 MHz)

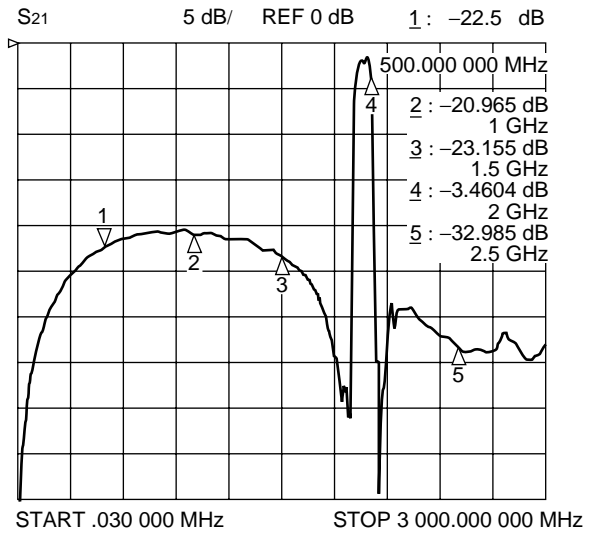
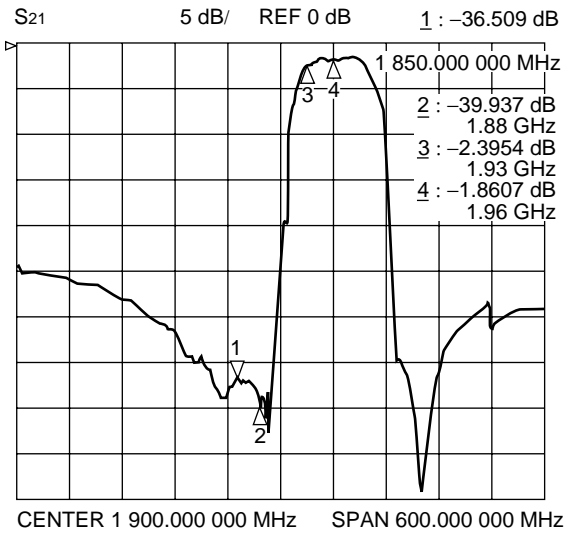

Filter 2 (Pass-band : 1960 MHz to 1990 MHz)

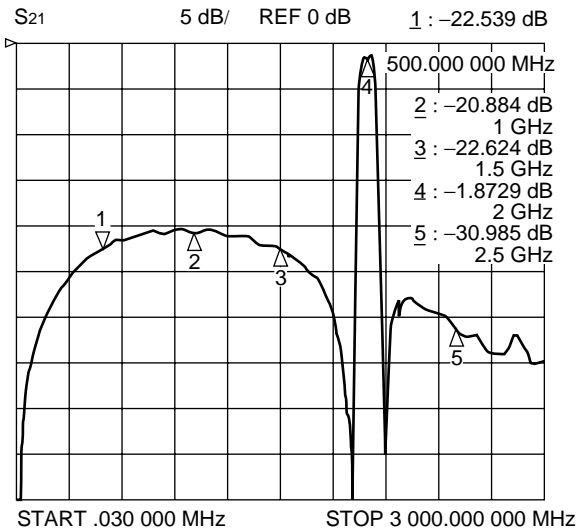
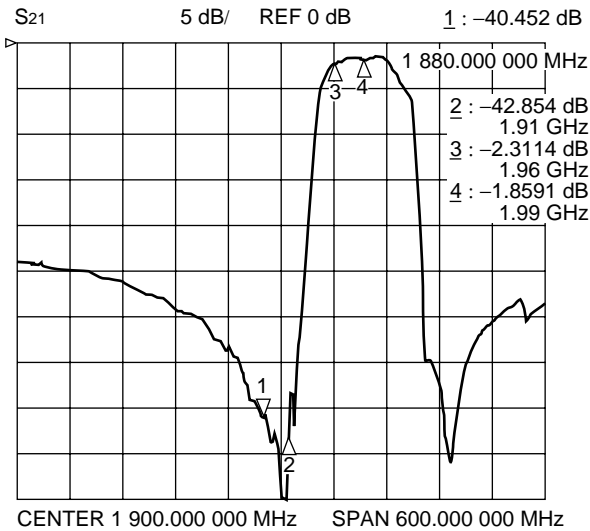

G5/G6 Series

MEASUREMENT CIRCUIT

- 1 in/2 out type (G5CN filters)

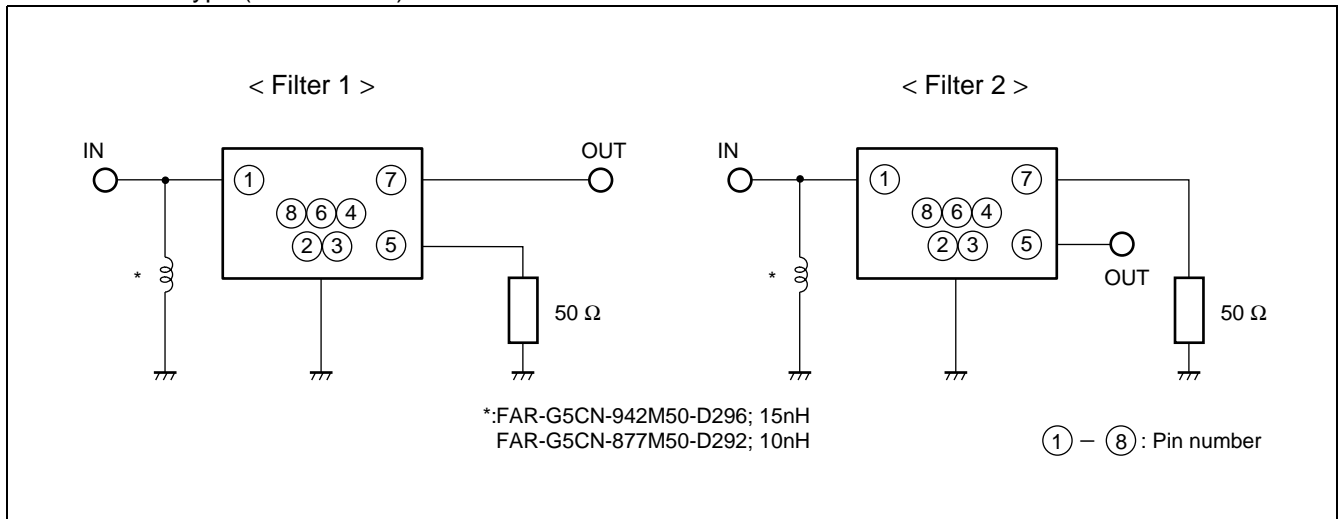

- 2 in/2 out type (G6CH filters)

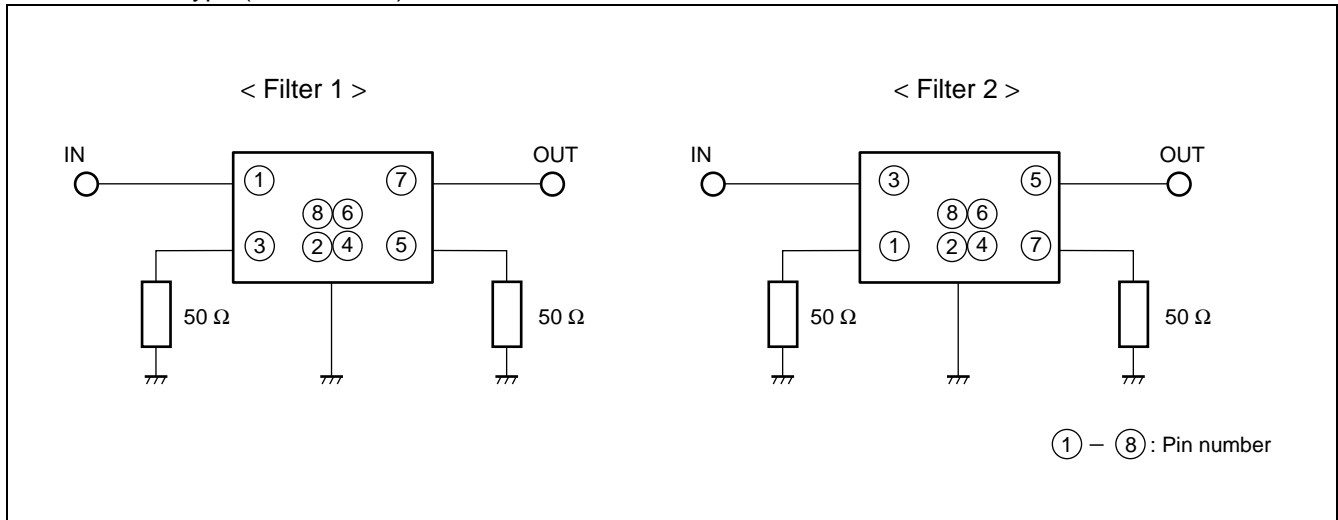

RECOMMENDED EXTERNAL CIRCUIT OF 1 IN/2 OUT TYPE

(G5CN filters)

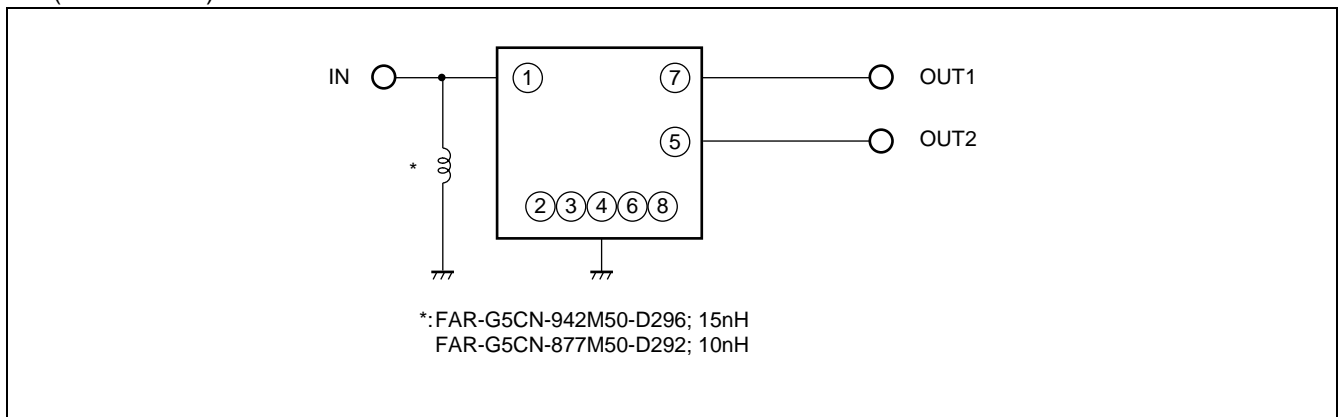

■ PART NUMBER DESIGNATION

[Designation example]

< G5CN FILTER >

FAR-G5CN-□□□□□□ -D2 □□ - □
 (1) (2) (3)

- (1) Frequency : This specifies the nominal center frequency of higher frequency side using six alphanumeric.
 M (for MHz) indicates the decimal point.
 [Example] 877M50 ⇒ 877.5 MHz
- (2) Part symbol : 01 to 99 (Numbers specified by Fujitsu)
- (4) Packing : Y; 1 k pcs/reel
 X ; 5 k pcs/reel

< G6CH FILTER >

FAR-G6CH-□□□□□□ -L2 □□ - □
 (1) (2) (3)

- (1) Frequency : This specifies the nominal center frequency of higher frequency side using six alphanumeric.
 G (for GHz) indicates the decimal point.
 [Example] 1G8800 ⇒ 1.88 GHz
- (2) Part symbol : 01 to 99 (Numbers specified by Fujitsu)
- (4) Packing : T; 1 k pcs/reel
 R; 3 k pcs/reel

< G6CN FILTER >

FAR-G6CN-□□□□□□ -L2 □□ - □
 (1) (2) (3)

- (1) Frequency : This specifies the nominal center frequency of higher frequency side using six alphanumeric.
 G (for GHz) indicates the decimal point.
 [Example] 1G8950 ⇒ 1.895 GHz
- (2) Part symbol : 01 to 99 (Numbers specified by Fujitsu)
- (4) Packing : Y; 1 k pcs/reel
 X ; 5 k pcs/reel

■ MARKING

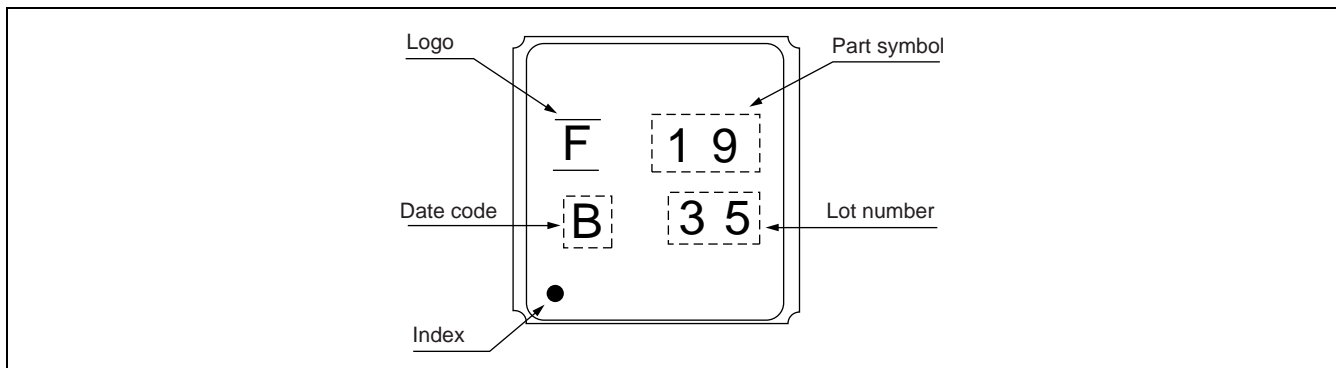

G5/G6 Series

PACKAGE DIMENSIONS

< G5CN package >
< G6CN package >

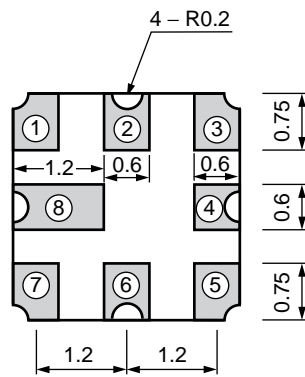
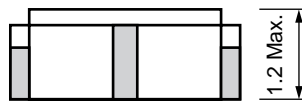
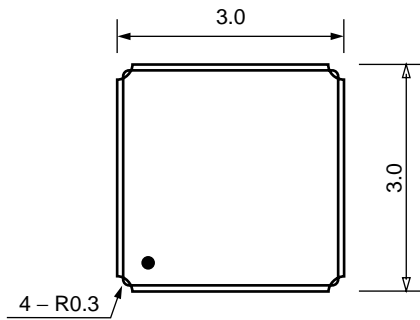

< G6CH package >

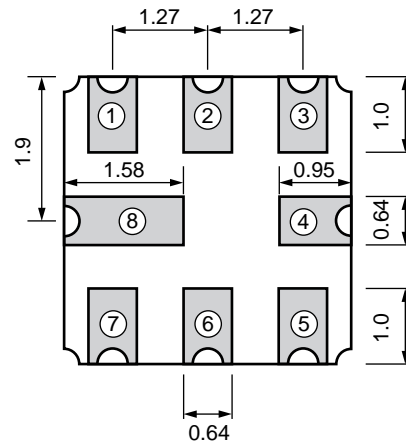
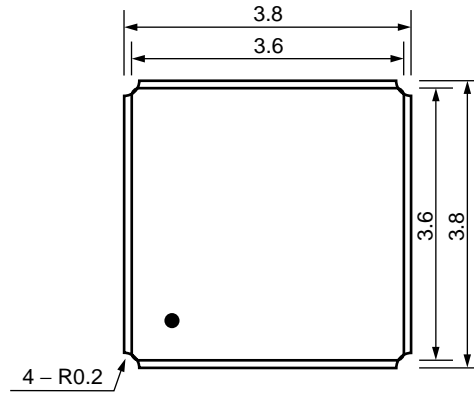

Dimensions in mm.

RECOMMENDED LAND PATTERN

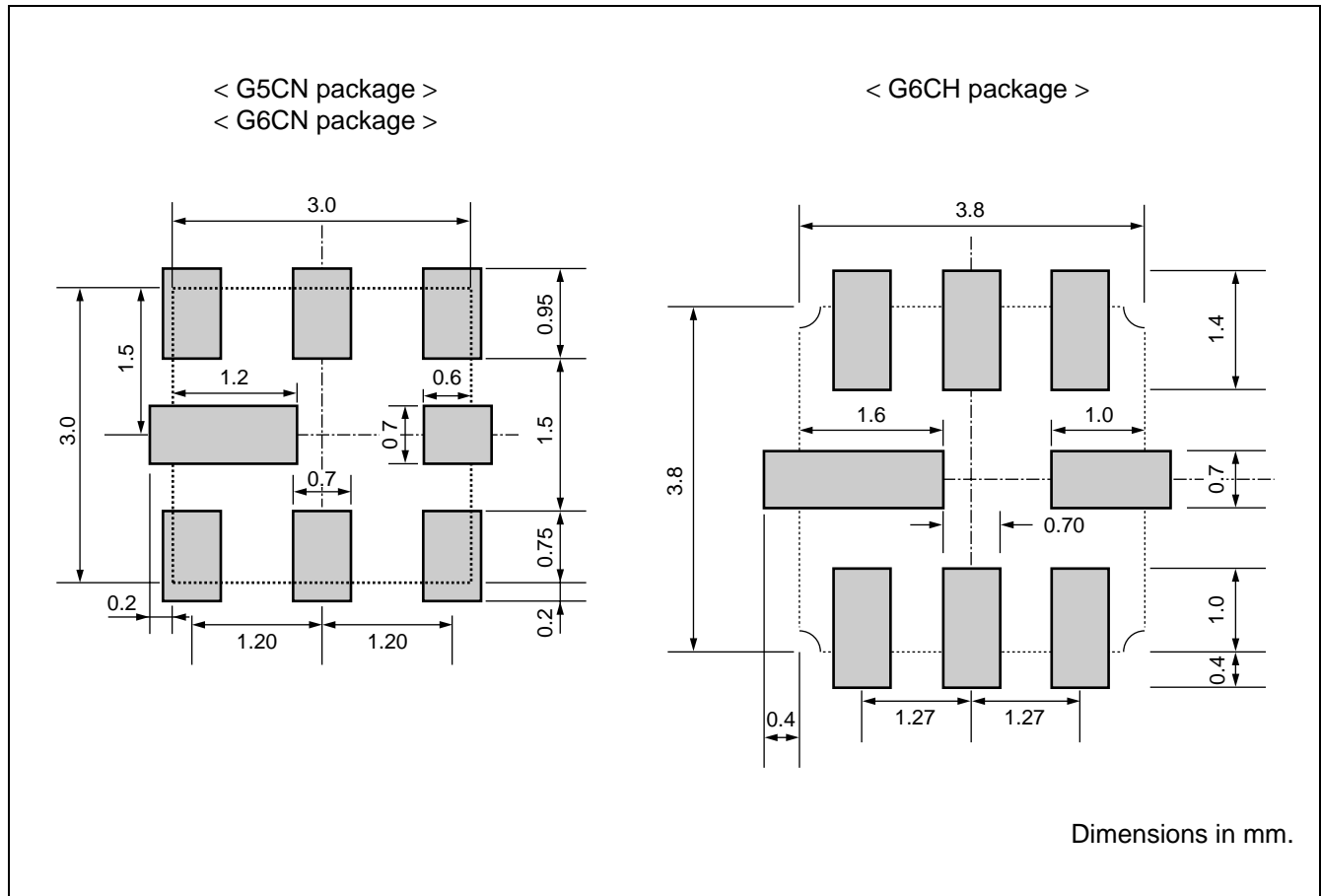

G5/G6 Series

PACKING

1. Reel Dimensions

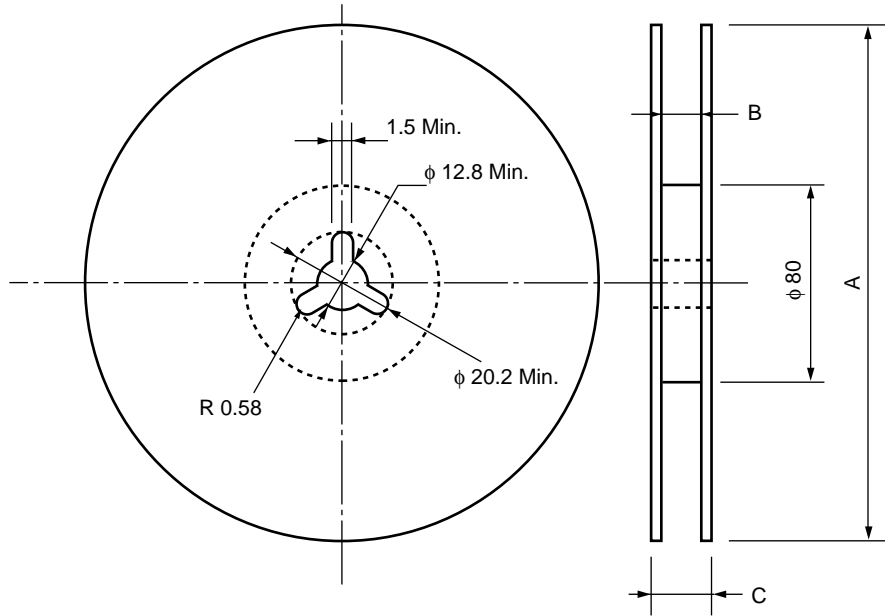

< G5CN filter >

< G6CN filter >

Type	A	B	C	Volume
Y	φ 250	9.5 ± 0.5	13.8 Max.	1 k pcs
X	φ 250	9.5 ± 0.5	13.8 Max.	5 k pcs

< G6CH filter >

Type	A	B	C	Volume
T	φ 250	12.4 ^{+2.0} _{-0.0}	18.4 Max.	1 k pcs
R	φ 330	12.4 ^{+2.0} _{-0.0}	18.4 Max.	3 k pcs

Dimensions in mm.

2. Packing Style

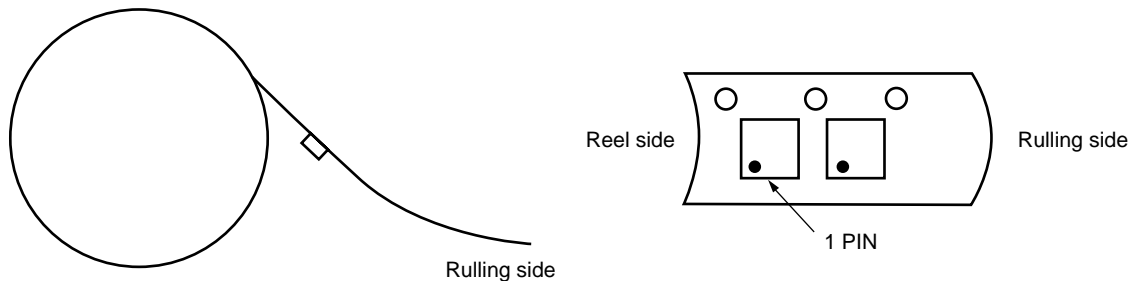

3. Tape Dimensions

< G5CN filters >
< G6CN filters >

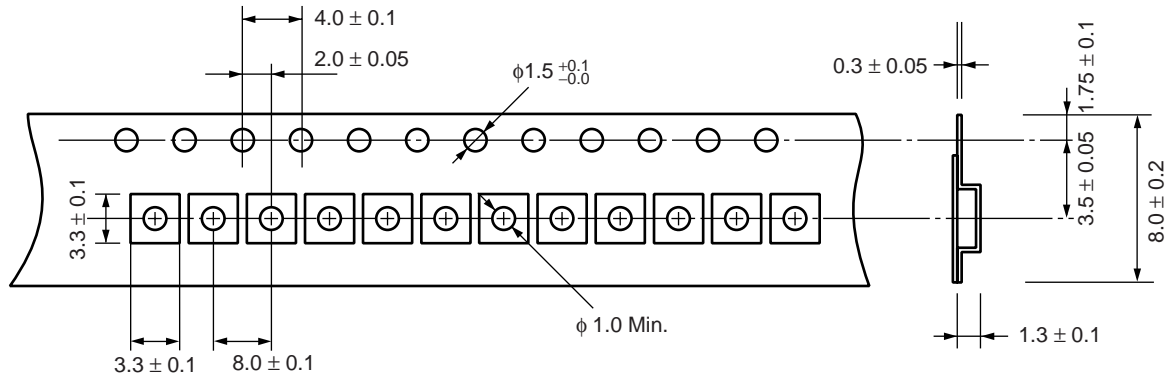

< G6CH filters >

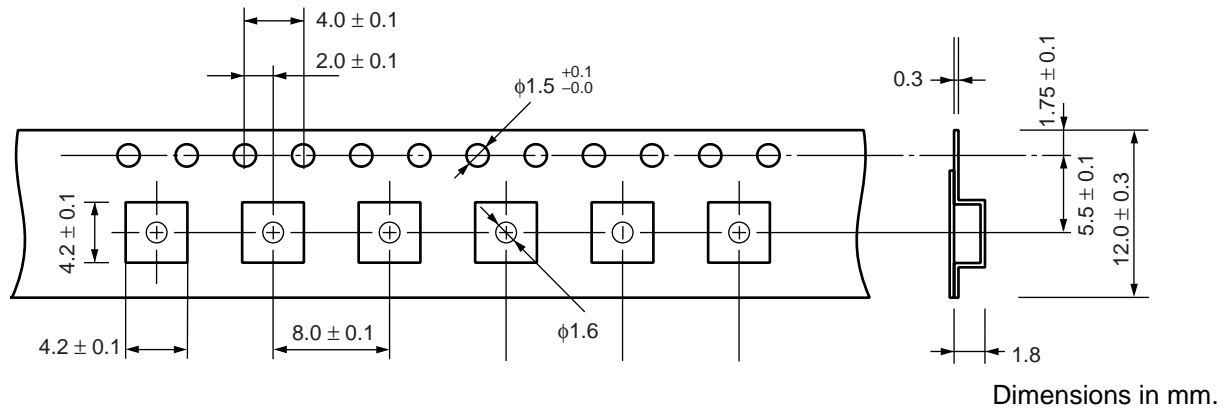

Dimensions in mm.

4. Peel strength of top cover tape

Peel off by the force of 0.1 N to 1.0 N under the condition at the right.
(Conforms to EIA.)

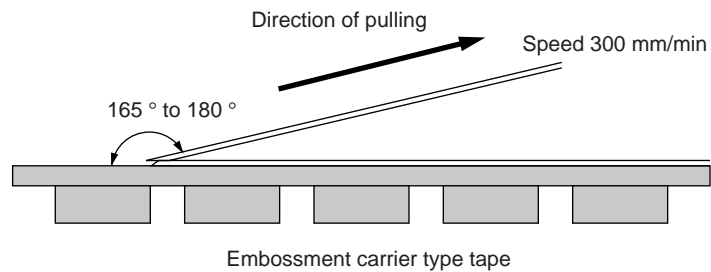

G5/G6 Series

RECOMMENDED REFLOW PROFILE

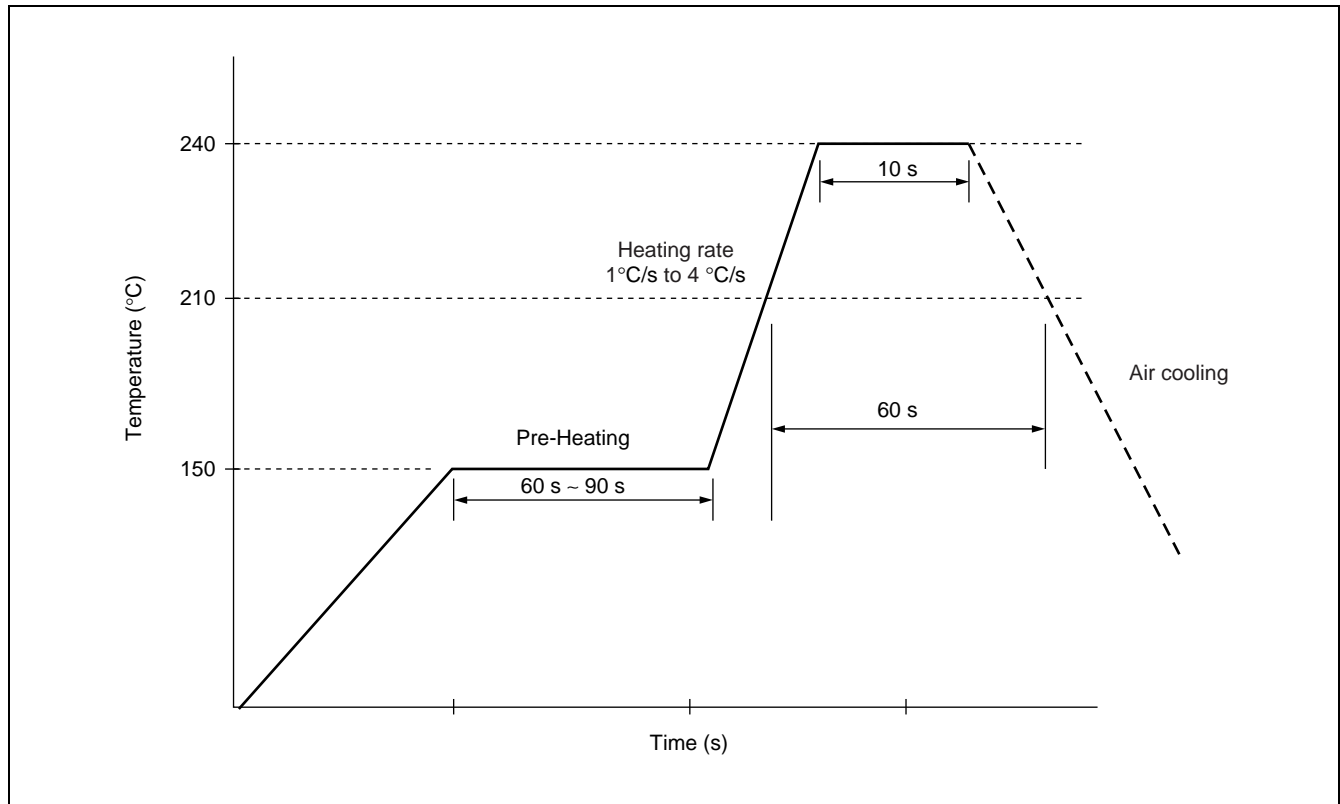

NOTE

Mass-produced product order is accepted by a unit of 1000.

FUJITSU MEDIA DEVICES LIMITED

For further information please contact:

Japan

FUJITSU MEDIA DEVICE LIMITED
International Sales & Marketing DEPT.
Shin-Yokohama Square Bldg., 14F,
Shin-yokohama 2-3-12,
Kohoku-ku, Yokohama,
Kanagawa 222-0033, Japan
Tel: +81-45-471-0061
Fax: +81-45-471-0076

<http://edevice.fujitsu.com/fmd/>

North and South America

FUJITSU MEDIA DEVICES OF AMERICA, INC.
1731 Technology Drive, Suite 800,
San Jose, CA 95110 U.S.A.
Tel: (1)-408-437-8900
Fax: (1)-408-437-0700

<http://www.fujitsumedia.com/>

Europe

FUJITSU MICROELECTRONICS EUROPE GmbH
Am Siebenstein 6-10,
D-63303 Dreieich-Buchsschlag,
Germany
Tel: +49-6103-690-0
Fax: +49-6103-690-122

<http://www.fujitsu-fme.com/>

Asia Pacific

FUJITSU MICROELECTRONICS ASIA PTE. LTD.
#05-08, 151 Lorong Chuan,
New Tech Park,
Singapore 556741
Tel: +65-281-0770
Fax: +65-281-0220

<http://www.fmal.fujitsu.com/>

F0107

© FUJITSU LIMITED Printed in Japan

All Rights Reserved.

The contents of this document are subject to change without notice. Customers are advised to consult with FUJITSU MEDIA DEVICES sales representatives before ordering.

The information and circuit diagrams in this document are presented as examples of device applications, and are not intended to be incorporated in devices for actual use. Also, FUJITSU MEDIA DEVICES is unable to assume responsibility for infringement of any patent rights or other rights of third parties arising from the use of this information or circuit diagrams.

The products described in this document are designed, and manufactured as contemplated for general use, including without limitation, ordinary industrial use, general office use, personal use, and household use, but are not designed, developed and manufactured as contemplated (1) for use accompanying fatal risks or dangers that, unless extremely high safety is secured, could have a serious effect to the public, and could lead directly to death, personal injury, severe physical damage or other loss (i.e., nuclear reaction control in nuclear facility, aircraft flight control, air traffic control, mass transport control, medical life support system, missile launch control in weapon system), or (2) for use requiring extremely high reliability (i.e., submersible repeater and artificial satellite).

Please note that Fujitsu will not be liable against you and/or any third party for any claims or damages arising in connection with above-mentioned uses of the products.

Any electronic devices have inherently a certain rate of failure. You must protect against injury, damage or loss from such failures by incorporating safety design measures into your facility and equipment such as redundancy, fire protection, and prevention of over-current levels and other abnormal operating conditions.

If any products described in this document represent goods or technologies subject to certain restrictions on export under the Foreign Exchange and Foreign Trade Control Law of Japan, the prior authorization by Japanese government should be required for export of those products from Japan.