

ASSP For Screen Display Control

CMOS

ON-Screen Display Controller

MB90097

■ DESCRIPTION

The MB90097 is the on-screen display controller for displaying text and graphics on the TV screen. Since it has a three-channel output control function, small package, and low voltage requirement for operation, it is suitable for on-screen display on video equipment such as camera-integrated VTRs.

The MB90097 provides a display screen made up of 28 characters by 12 lines, capable of displaying 512 different characters each consisting of 12×18 dots. The display functions of the MB90097 includes a wealth of character qualifying functions such as character background shading (shadow casting) and individual character size setting, supporting 16-color display for each character. They also include the line background, screen background, and sprite character display functions, enabling the screen to be displayed in a variety of configurations. The integrated font ROM contains 512 different character patterns all of which can be set by the user.

■ FEATURES

- Character screen configuration: 28 characters \times 12 lines (maximum)
- Character types: 512 different characters (integrated in ROM, user-definable through the entire area)

(Continued)

■ PACKAGE

20-pin Plastic SSOP

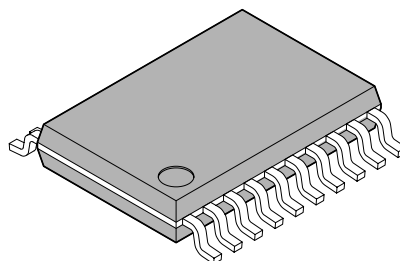

(FPT-20P-M03)

(Continued)

- Font configuration: 12 × 18 dots (font ROM configuration)
Capable of specifying the horizontal and vertical sizes of characters to be displayed.
 - One of the following three horizontal sizes (S, M, L) can be set for each character:
 - S size : 6 dots
 - M size : 9 dots
 - L size : 12 dots
 - Either of the following two vertical sizes (A, B) can be set for each line.
 - A : 18 dots
 - B : 12 dots
- Display modes: Character trimming Enabled/Disabled (Set for each line)
 - Character background None/Solid-fill/Shaded background (concaved)/Shaded background (convex) (Set for each line)
 - Horizontal character merge/independent display with shaded background (Set for each character)
 - Vertical line merge/independent display with shaded background (Set for each line)
 - Character background extended display ON/OFF for line spacings (Set for each line)
 - Line background None/Solid-fill/Shaded background (concaved)/Shaded background (convex) (Set for each line)
(Display extended to the left and right margins of the screen and to the line spacing)
 - Character enlargement: Four types supported: Normal, Double width, Double height, Double width × double height
(Set for each line)
 - Enlarged display dot interpolation function (Set for each line)
- Character screen display position control:
 - Horizontal display position Control in 2-dot units (movable through the entire screen)
 - Vertical display position Control in 2-dot units (movable through the entire screen)
 - Line spacing control Control in 1-dot units (Set between 0 to 7 dots for each line; Displayed simultaneously at two areas above and below the line.)
- Sprite character control:
 - Sprite character display OFF/ON
 - Sprite character types 256 types (character codes: 000_H to 0FF_H)
 - Sprite character trimming Enabled/Disabled
 - Sprite character configuration Two types: 1 character/Stack of 2 characters
 - Sprite character horizontal display position Control in 1-dot units (movable through the entire screen)
 - Sprite character vertical display position Control in 1-dot units (movable through the entire screen)

(Continued)

(Continued)

- Screen background control: Screen background color OFF/ON
- Display colors
 - Character color: 16 colors (Set for each character)
 - Character trimming color: 16 colors (Set for each line)
 - Character background color: 16 colors (Set for each character) *
 - Line background color: 16 colors (Set for each line)
 - Screen background color: 16 colors
 - Sprite character color: 16 colors
 - Sprite character trimming color: 16 colors
 - Shaded background frame highlight color: 16 colors
 - Shaded background frame shadow color: 16 colors
- Display signal output: Color signal output: 4 bits (Supporting 16 colors)
Display period signals: 3 channels (Output selector circuit provided)
- External interface: 16-bit serial inputs
 - Chip select
 - Serial clock
 - Serial data
- Package : SSOP-20
- Supply voltage: 3.3 V

*: Transparent (Displaying the lower-layer color) when the character background color (color code) = "0"

MB90097

■ PIN ASSIGNMENT

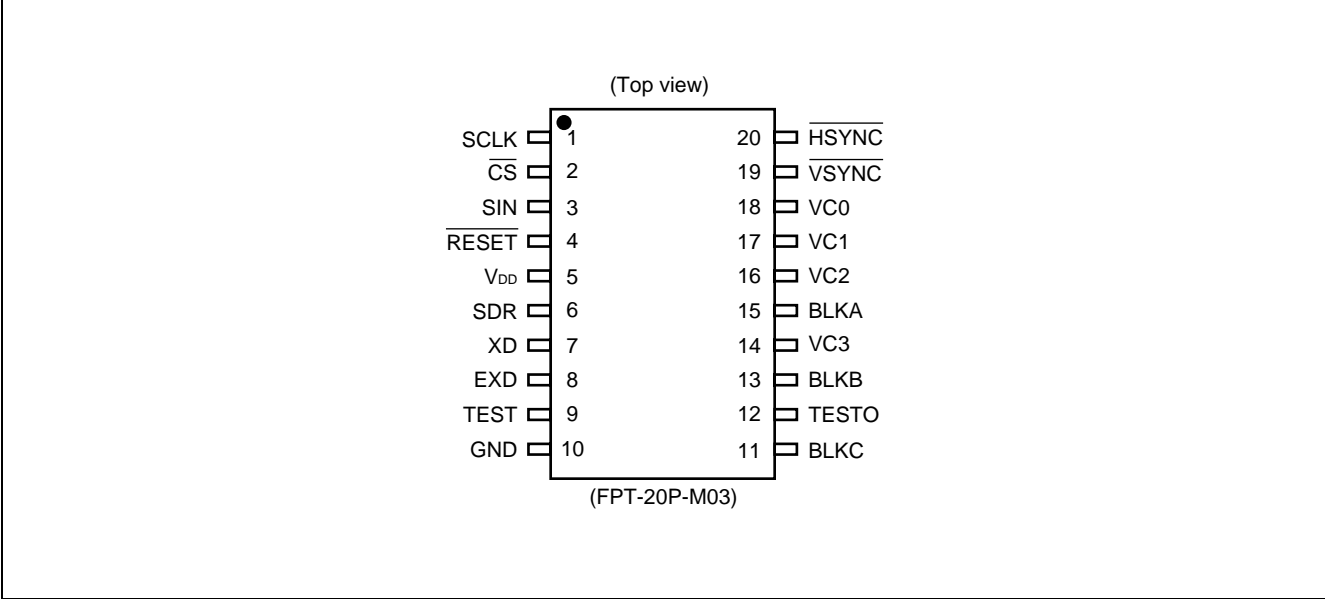

■ PIN DESCRIPTIONS

Pin no.	Pin name	I/O	Function
1	SCLK	I	Shift clock input pin for serial transfer This pin has an internal pull-up resistor.
2	$\overline{\text{CS}}$	I	Chip select pin This pin inputs a Low level signal for serial transfer. The pin has an internal pull-up resistor.
3	SIN	I	Serial data input pin This pin has an internal pull-up resistor.
4	$\overline{\text{RESET}}$	I	Reset input pin This pin inputs a Low level signal when turning the power on.
5	V _{DD}	—	+ 3 V power supply pin
6	SDR	I	Data input direction select pin for serial transfer This pin inputs the Low level signal in the LSB-first transfer mode for data input; it inputs the High level signal in the MSB-first transfer mode.
7 8	XD EXD	O I	External circuit pins for display dot clock generator Connect these pins to external "L" and "C" to form an LC oscillator circuit. For external input of a display dot clock, input the clock signal to the EXD pin and leave the XD pin open.
9	TEST	I	LSI test input pin Input the Low level signal during normal use.
10	GND	—	Ground pin
20	$\overline{\text{HSYNC}}$	I	Horizontal sync signal input pin
19	$\overline{\text{VSYNC}}$	I	Vertical sync signal input pin
18 17 16 14	VC0 VC1 VC2 VC3	O O O O	Color code signal output pin
15	BLKA	O	Display period signal output pin for output channel A
13	BLKB	O	Display period signal output pin for output channel B
11	BLKC	O	Display period signal output pin for output channel C
12	TESTO	O	LSI test output pin Leave this pin open (unconnected) during normal use.

■ ABSOLUTE MAXIMUM RATINGS

($V_{GND} = 0\text{ V}$)

Parameter	Symbol	Rating		Unit	Remarks
		Min.	Max.		
Power supply voltage	V_{DD}	$V_{GND} - 0.3$	$V_{GND} + 4.5$	V	
Input voltage	V_{IN}	$V_{GND} - 0.3$	$V_{DD} + 0.3$	V	
Output voltage	V_{OUT}	$V_{GND} - 0.3$	$V_{DD} + 0.3$	V	
Power consumption	P_d	—	100	mW	
Operating temperature	T_a	- 40	+ 85	°C	
Storage temperature	T_{stg}	- 55	+ 150	°C	

WARNING: Semiconductor devices can be permanently damaged by application of stress (voltage, current, temperature, etc.) in excess of absolute maximum ratings. Do not exceed these ratings.

■ RECOMMENDED OPERATING CONDITIONS

($V_{GND} = 0\text{ V}$)

Parameter	Symbol	Value		Unit	Remarks
		Min.	Max.		
Power supply voltage	V_{DD}	3.0	3.6	V	
“H” level input voltage	V_{IHS}	$0.8 \times V_{DD}$	$V_{DD} + 0.3$	V	
“L” level input voltage	V_{ILS}	V_{GND}	$0.2 \times V_{DD}$	V	
Operating temperature	T_a	- 40	+ 85	°C	

WARNING: The recommended operating conditions are required in order to ensure the normal operation of the semiconductor device. All of the device’s electrical characteristics are warranted when the device is operated within these ranges.

Always use semiconductor devices within their recommended operating condition ranges. Operation outside these ranges may adversely affect reliability and could result in device failure.

No warranty is made with respect to uses, operating conditions, or combinations not represented on the data sheet. Users considering application outside the listed conditions are advised to contact their FUJITSU representatives beforehand.

■ ELECTRICAL CHARACTERISTICS

1. DC Characteristics

($V_{GND} = 0\text{ V}$, $T_a = -40^\circ\text{C}$ to $+85^\circ\text{C}$)

Parameter	Symbol	Pin name	Conditions	Value			Unit
				Min.	Typ.	Max.	
"H" level output voltage 1	V_{OH1}	VC3 VC2 VC1 VC0	$V_{DD} = 3.0\text{ V}$ $I_{OH} = -4.0\text{ mA}$	$V_{DD} - 0.5$	—	—	V
"L" level output voltage 1	V_{OL1}	BLKC BLKB BLKA	$V_{DD} = 3.0\text{ V}$ $I_{OL} = 4.0\text{ mA}$	—	—	0.4	V
"H" level output voltage 2	V_{OH2}	XD	$V_{DD} = 3.0\text{ V}$ $I_{OH} = -0.5\text{ mA}$	$V_{DD} - 0.5$	—	—	V
"L" level output voltage 2	V_{OL2}		$V_{DD} = 3.0\text{ V}$ $I_{OL} = 0.5\text{ mA}$	—	—	0.4	V
"H" level input current	I_{IH}	SDR HSYNC VSYNC	$V_{DD} = 3.3\text{ V}$ $V_{IH} = V_{DD}$	—	—	-10	μA
"L" level input current	I_{IL}	EXD TEST RESET	$V_{DD} = 3.3\text{ V}$ $V_{IL} = 0\text{ V}$	—	—	10	μA
PULL-UP resistance	R_{PULL}	SIN SCLK CS	$V_{DD} = 3.3\text{ V}$	20	—	110	$\text{k}\Omega$
Power supply current	I_{CC}	V_{DD}	$V_{DD} = 3.0\text{ V}$ $f_{DC} = 8\text{ MHz}$	—	4	6	mA
			$V_{DD} = 3.6\text{ V}$ $f_{DC} = 8\text{ MHz}$	—	5	7	mA
Input capacitance	C	except V_{DD} , GND	—	—	10	—	pF

2. AC Characteristics

(1) Serial input timings

($V_{DD} = 3.0\text{ V to }3.6\text{ V}$, $V_{GND} = 0\text{ V}$, $T_a = -40^\circ\text{C to }+85^\circ\text{C}$)

Parameter	Symbol	Pin name	Value		Unit
			Min.	Max.	
Shift clock cycle time	t_{CYC}	SCLK	250	—	ns
Shift clock pulse width	t_{WCH}	SCLK	100	—	ns
	t_{WCL}		100	—	ns
Shift clock signal rise/fall time	t_{CR}	SCLK	—	200	ns
	t_{CF}		—	200	ns
Shift clock start time	t_{SS}	SCLK	100	—	ns
Data setup time	t_{SU}	SIN	100	—	ns
Data hold time	t_H	SIN	50	—	ns
Chip select end time	t_{EC}	\overline{CS}	100	—	ns
Chip select signal rise/fall time	t_{CRC}	\overline{CS}	—	200	ns
	t_{CFC}		—	200	ns

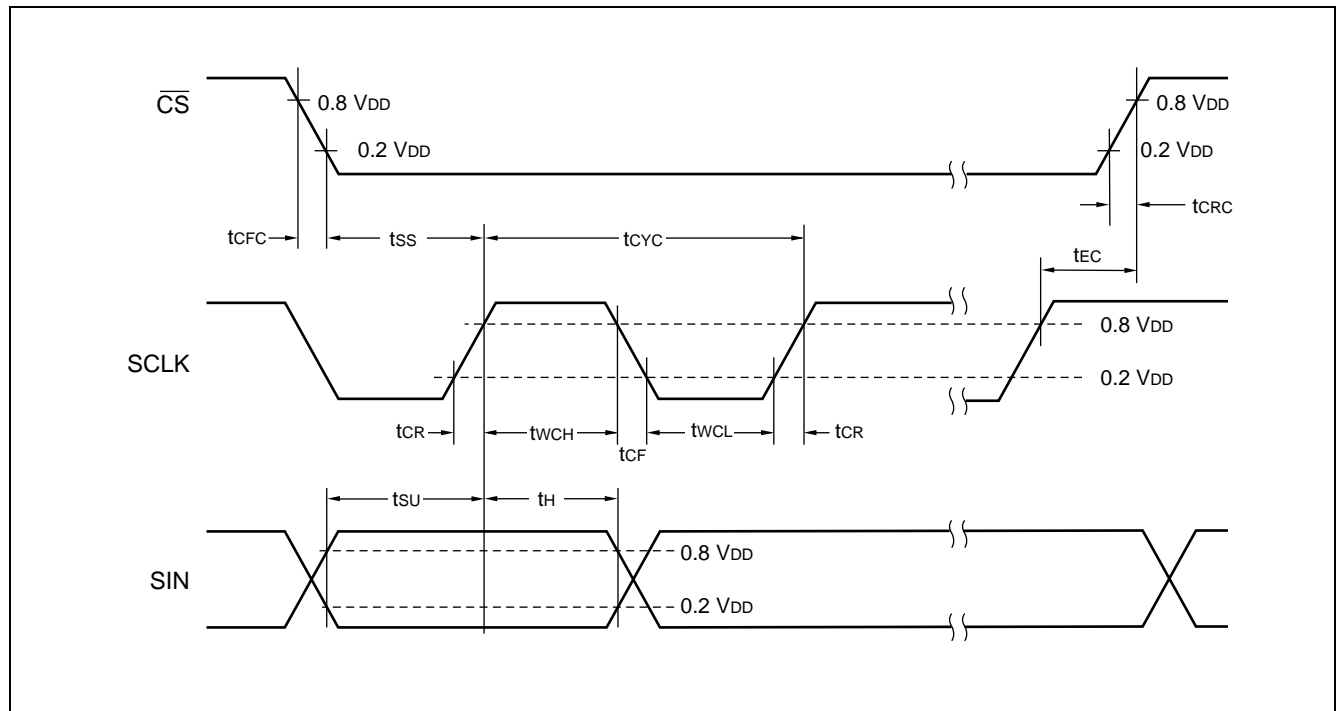

(2) Vertical and horizontal sync signal input timings

($V_{DD} = 3.0\text{ V to }3.6\text{ V}$, $V_{GND} = 0\text{ V}$, $T_a = -40^\circ\text{C to }+85^\circ\text{C}$)

Parameter	Symbol	Pin name	Value		Unit
			Min.	Max.	
Horizontal sync signal rise time	t_{HR}	$\overline{\text{HSYNC}}$	—	200	ns
Horizontal sync signal fall time	t_{HF}	$\overline{\text{HSYNC}}$	—	200	ns
Vertical sync signal rise time	t_{VR}	$\overline{\text{VSYNC}}$	—	200	ns
Vertical sync signal fall time	t_{VF}	$\overline{\text{VSYNC}}$	—	200	ns
Horizontal sync signal pulse width ^{*1}	t_{WH}	$\overline{\text{HSYNC}}$	18	—	Dot clock
			—	6	μs
Vertical sync signal setup time ^{1,2} (Except for $\text{WE} = 1$, $\text{VHE} = 1$, $\text{HE} = 1$) ^{*3}	t_{VS}	$\overline{\text{VSYNC}}$	4	$1H - 4$	Dot clock
Vertical sync signal setup time ^{2,2} ($\text{WE} = 1$, $\text{VHE} = 1$, $\text{HE} = 1$) ^{*3}	t_{VS}	$\overline{\text{VSYNC}}$	-6	$1H - 14$	Dot clock
Vertical sync signal detection hold time	t_{VH}	$\overline{\text{VSYNC}}$	2	—	H
Vertical sync signal pulse width	t_{wv}	$\overline{\text{VSYNC}}$	2	20	H

*1: During the horizontal sync signal pulse period, the MB90097 stops its internal operation, disabling writing to the internal VRAM. Therefore, set the horizontal sync signal pulse width and VRAM write cycle (command 2 or command 4 issuance cycle) to ensure that: horizontal sync signal pulse width < VRAM write cycle.

*2: Do not change the vertical sync signal (detection edge) in the vicinity of the horizontal sync signal edge of vertical sync signal detection. Otherwise, it results in a deflection in the display when the sync signal fluctuates.

*3: VVE, VHE and HE are control bits of Command 13-0 (I/O pin control) .

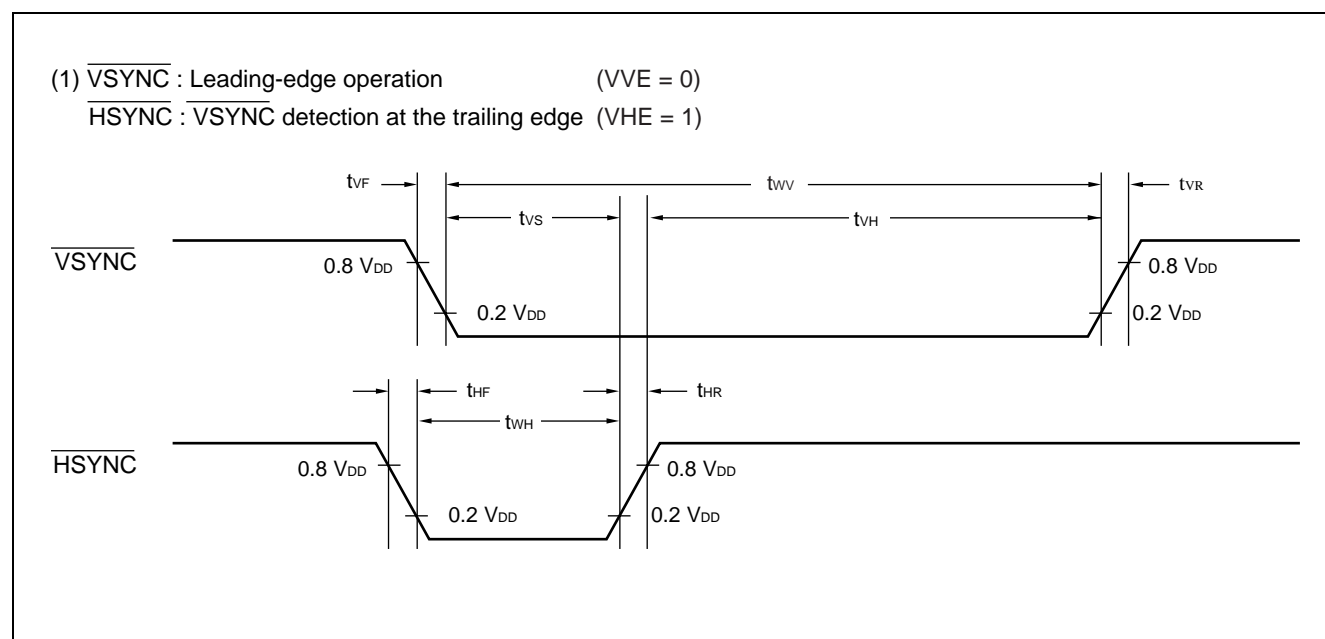

Note: The above diagrams assume that sync signal input control (SIX bit) of I/O pin control (command 13-0) has been set to negative logic (0). The H and L levels are inverted if it has been set to positive logic.

(Continued)

(Continued)

(2) $\overline{\text{VSYNC}}$: Trailing-edge operation (VVE = 1)
 $\overline{\text{HSYNC}}$: $\overline{\text{VSYNC}}$ detection at the trailing edge (VHE = 1 and HE = 0)

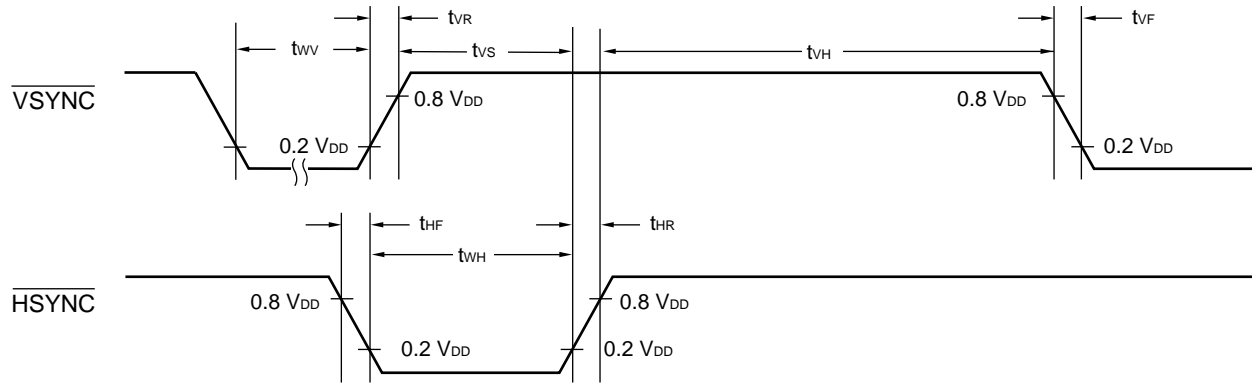

(3) $\overline{\text{VSYNC}}$: Leading-edge operation (VVE = 0)
 $\overline{\text{HSYNC}}$: $\overline{\text{VSYNC}}$ detection at the leading edge (VHE = 0)

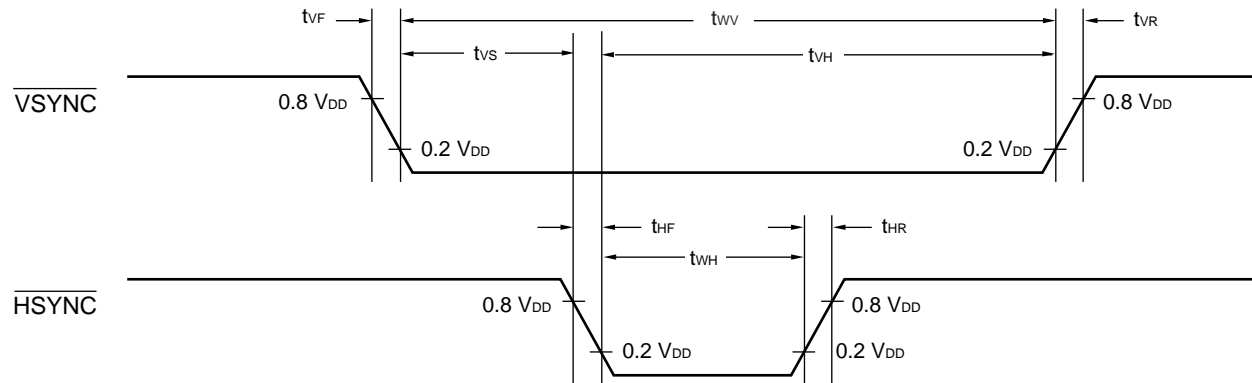

(4) $\overline{\text{VSYNC}}$: Trailing-edge operation (VVE = 1)
 $\overline{\text{HSYNC}}$: $\overline{\text{VSYNC}}$ detection at the leading edge (VHE = 0) or (VHE = 1 and HE = 1)

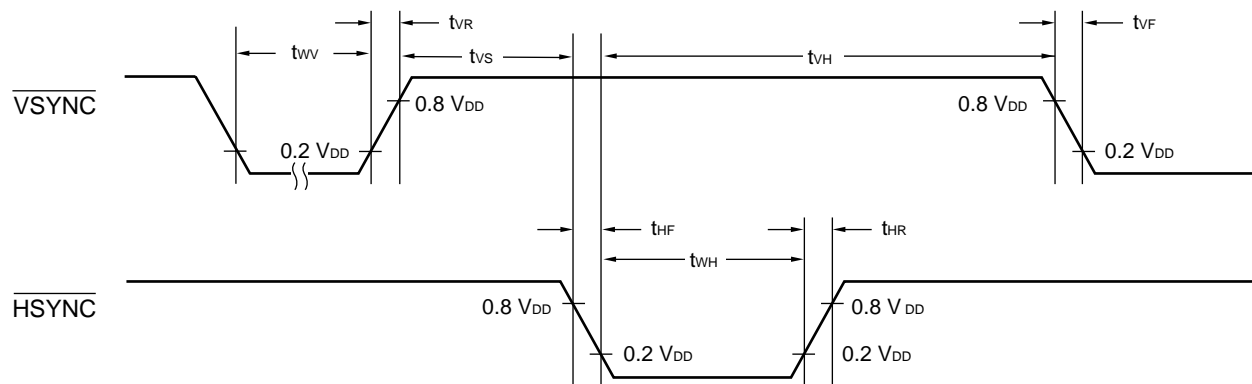

(4) Dot clock input timing

($V_{DD} = 3.0\text{ V to }3.6\text{ V}$, $V_{GND} = 0\text{ V}$, $T_a = -40^\circ\text{C to }+85^\circ\text{C}$)

Parameter	Symbol	Pin name	Value		Unit	Remarks
			Min.	Max.		
Dot clock cycle time	t_{DCYC1}	EXD	112	166	ns	*1
	t_{DCYC2}	EXD	56	83	ns	*2
Dot clock pulse time	t_{DWH1}	EXD	48	—	ns	*1
	t_{DWL1}		48	—	ns	
	t_{DWH2}	EXD	24	—	ns	*2
	t_{DWL2}		24	—	ns	
$\overline{\text{HSYNC}}$, $\overline{\text{VSYNC}}$ setup time	t_{DS}	$\overline{\text{HSYNC}}$	13	—	ns	*3
$\overline{\text{HSYNC}}$, $\overline{\text{VSYNC}}$ hold time	t_{DH}	$\overline{\text{VSYNC}}$	0	—	ns	*3
Data output delay time 1	t_{DD1}	VC3, VC2, VC1, VC0,	7	t_{DD2}	ns	*3
Data output delay time 2	t_{DD2}	BLKA, BLKB, BLKC	t_{DD1}	45	ns	

*1: Assumes a dot clock LC oscillator circuit or external dot clock input.

*2: Assumes frequency-doubled external dot clock input.

*3: Assumes dot clock external input.

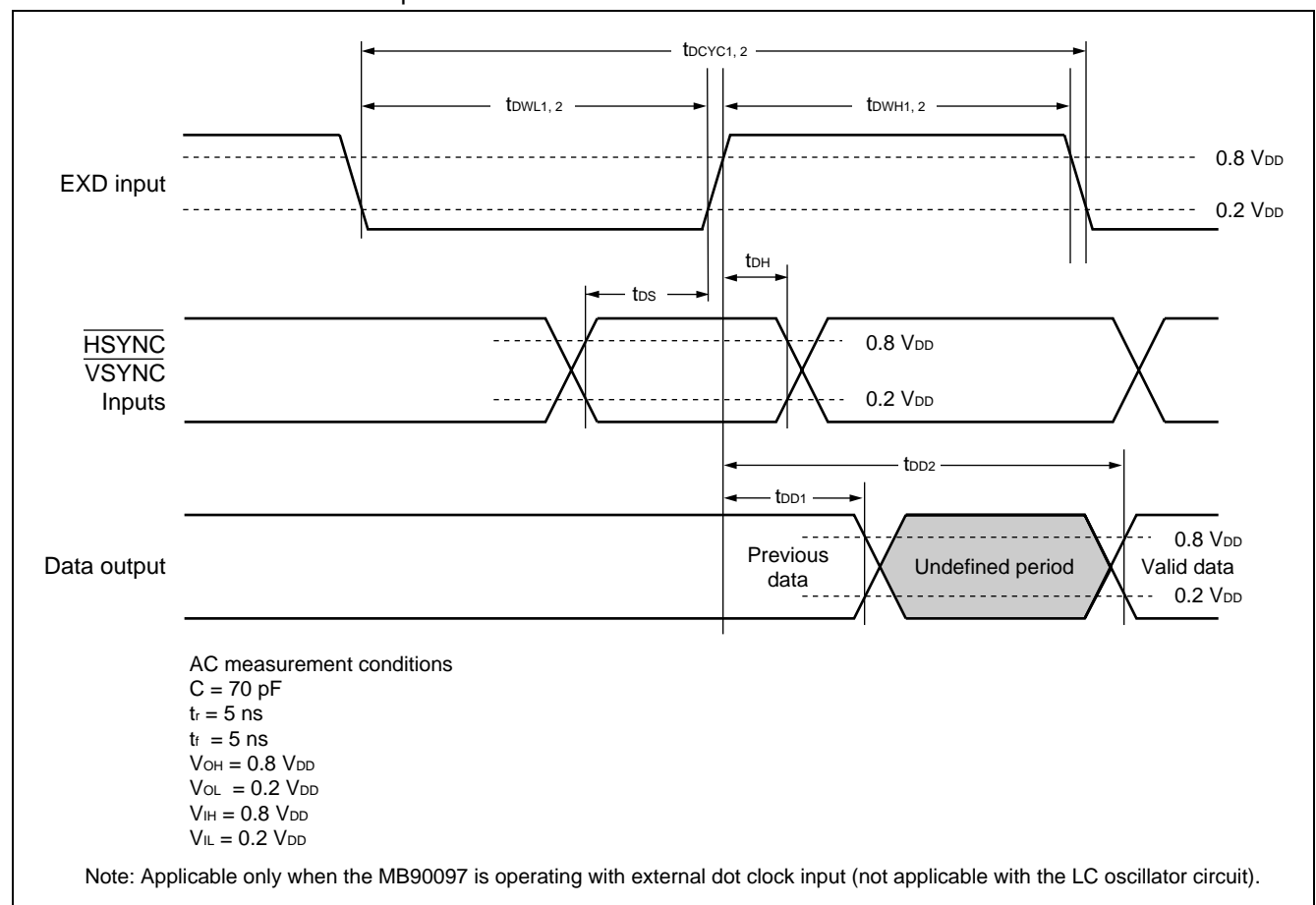

(4) Reset input timing

($V_{DD} = 3.0\text{ V to }3.6\text{ V}$, $V_{GND} = 0\text{ V}$, $T_a = -40^\circ\text{C to }+85^\circ\text{C}$)

Parameter	Symbol	Pin name	Value		Unit	Remarks
			Min.	Max.		
Reset pulse width	t_{WRST}	RESET	1	—	μs	
Clock input time	t_{WRSD}	EXD	5	—	Dot clock	Note

Note: To feed the EXD pin with the dot clock, it is necessary to input the clock during RESET. Configuring LC oscillator circuit using the external L and C will eliminate this need because it will automatically oscillate.

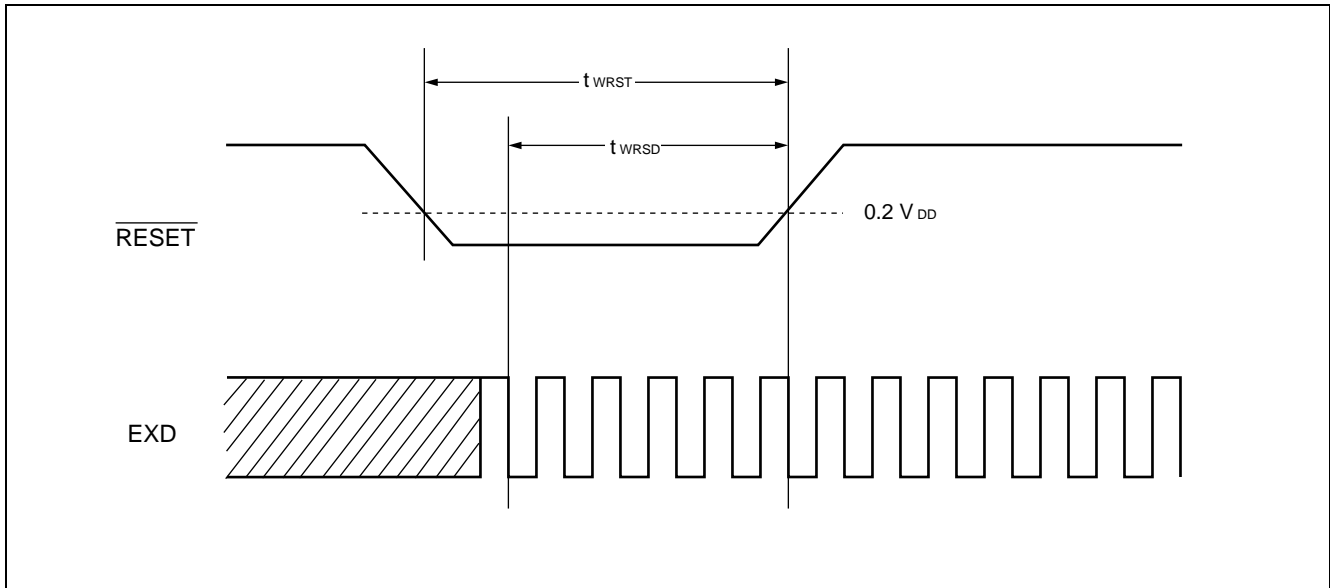

■ COMMAND LIST

1. Display Control Commands

Command no.	Function	Command code/data													
		15 to 12	11	10	9	8	7	6	5	4	3	2	1	0	
0	VRAM write address setting	0000	AY3	AY2	AY1	AY0	FL	0	0	AX4	AX3	AX2	AX1	AX0	
1	Character data setting 1	0001	MS1	MS0	MM1	MM0	MB3	MB2	MB1	MB0	MC3	MC2	MC1	MC0	
2	Character data setting 2	0010	MR	MO1	MO0	M8	M7	M6	M5	M4	M3	M2	M1	M0	
3	Line control data setting 1	0011	LHS	LW2	LW1	LW0	LFD	LFC	LFB	LFA	LF3	LF2	LF1	LF0	
4	Line control data setting 2	0100	LDS	LGS	LG1	LG0	LD	LE	LM1	LM0	L3	L2	L1	L0	
5-00	Screen output control 1A	0101	0	0	0	0	SDS	UDS	0	DSP	0	OA2	OA1	OA0	
5-01	Screen output control 1B	0101	0	0	0	1	SOB	BGB	BLB	0	0	OB2	OB1	OB0	
5-02	Screen output control 1C	0101	0	0	1	0	SOC	BGC	BLC	0	0	OC2	OC1	OC0	
5-2	Vertical display position control	0101	1	0	0	Y8	Y7	Y6	Y5	Y4	Y3	Y2	Y1	Y0	
5-3	Horizontal display position control	0101	1	1	0	X8	X7	X6	X5	X4	X3	X2	X1	X0	
6-1	Shaded background frame color control	0110	0	1	0	0	BH3	BH2	BH1	BH0	BS3	BS2	BS1	BS0	
7-3	Screen background control	0111	1	1	0	0	0	0	0	0	U3	U2	U1	U0	
8-0	Sprite character control 1	1000	0	0	SFB	SFA	SF3	SF2	SF1	SF0	SC3	SC2	SC1	SC0	
8-1	Sprite character control 2	1000	0	1	SD1	SD0	SM7	SM6	SM5	SM4	SM3	SM2	SM1	SM0	
9-0	Sprite character control 4	1001	0	0	SY9	SY8	SY7	SY6	SY5	SY4	SY3	SY2	SY1	SY0	
9-1	Sprite character control 5	1001	1	0	SX9	SX8	SX7	SX6	SX5	SX4	SX3	SX2	SX1	SX0	
11-0	Screen extension control	1011	0	0	0	0	0	EG0	0	0	0	0	0	0	
11-2	Dot clock control 1	1011	1	0	0	0	0	0	0	0	0	DC2	DC1	DC0	
13-0	I/O pin control	1101	0	0	VVE	VHE	HE	0	SIX	0	0	0	DBX	DCX	
13-1	Horizontal blanking control 1	1101	0	1	0	0	0	0	BB5	BB4	BB3	BB2	BB1	BB0	
13-2	Horizontal blanking control 2	1101	1	0	0	BF8	BF7	BF6	BF5	BF4	BF3	BF2	BF1	BF0	

2. Command Description

- **Command 0 (VRAM write address setting)**

Command 0 sets the write address in VRAM and controls execution of “VRAM fill.”

The sets the write address by specifying the row and column addresses.

VRAM fill is activated by executing command 2 (character data setting 2).

15	14	13	12	11	10	9	8	7	6	5	4	3	2	1	0
0	0	0	0	AY3	AY2	AY1	AY0	FL	0	0	AX4	AX3	AX2	AX1	AX0

AY3 to AY0: Row address
(0 to B_H)

AX4 to AX0: Column address
(0 to 1B_H)

FL: VRAM fill control
(0: OFF, 1: ON)

- **Command 1 (Character data setting 1)**

Command 1 sets character data.

Executing command 2 (character data setting 2) sets VRAM to reflect it on the screen.

15	14	13	12	11	10	9	8	7	6	5	4	3	2	1	0
0	0	0	1	MS1	MS0	MM1	MM0	MB3	MB2	MB1	MB0	MC3	MC2	MC1	MC0

MC3 to MC0: Character color

(From among 16 colors)

MB3 to MB0: Character background color

(From among 16 colors)

MM1, MM0: Character background control

(0, 0: OFF)

(0, 1: Solid-fill display)

(1, 0: Concaved, shaded background)

(1, 1: Convexed, shaded background)

MS1, MS0: Character horizontal size control

(0, 0: S size, 6 dots)

(0, 1: M size, 9 dots)

(1, 0: L size, 12 dots)

(1, 1: Setting prohibited)

- **Command 2 (Character data setting 2)**

Command 2 writes additional character data to the location in VRAM specified by command 0 (VRAM write address setting 1), along with the character data set by command 1 (character data setting 1).

The VRAM write address is incremented automatically after execution of command 2.

15	14	13	12	11	10	9	8	7	6	5	4	3	2	1	0
0	0	1	0	MR	MO1	MO0	M8	M7	M6	M5	M4	M3	M2	M1	M0

MR: Shaded background succeeding character merge control

(0: Disables succeeding character merge display.)

(1: Enables succeeding character merge display.)

M8 to M0: Character code

MO1, MO0: Character output control

• Command 3 (Line control data setting 1)

Command 3 sets line control data.

Executing command 4 (line control data setting 2) sets VRAM to reflect it on the screen.

15	14	13	12	11	10	9	8	7	6	5	4	3	2	1	0
0	0	1	1	LHS	LW2	LW1	LW0	LFD	LFC	LFB	LFA	LF3	LF2	LF1	LF0

LHS: Line character vertical size type control
(0: Character vertical size A)
(1: Character vertical size B)

LW2 to LW0: Line spacing control
(0 to 7 dots in 1-dot units)

LF3 to LF0: Trimming color
(From among 16 colors)

LFD, LFC: Trimming output control
(0, 0: All OFF)

(0, 1: Trimming ON for character with no character background)

(1, 0: Trimming ON for solid-filled character with no character background)

(1, 1: All ON)

LFB, LFA: Trimming control

(0, 0: Trimming OFF)

(0, 1: Reserved (Setting prohibited))

(1, 0: Reserved (Setting prohibited))

(1, 1: Eight-direction trimming)

• Command 4 (Line control data setting 2)

Command 4 writes additional line control data to the row address in line RAM specified by command 0 (VRAM write address setting), along with the line control data set by command 3 (line control data setting1).

Executing this command will not alter the VRAM write address.

15	14	13	12	11	10	9	8	7	6	5	4	3	2	1	0
0	1	0	0	LDS	LGS	LG1	LG0	LD	LE	LM1	LM0	L3	L2	L1	L0

LDS: Line character output control
(Control of character + trimming + character background)
(0: OFF, 1: ON)

LGS: Line enlargement interpolation control
(0: OFF, 1: ON)

LG1, LG0: Line enlargement control
(0, 0: Normal)
(0, 1: Double width)
(1, 0: Double height)
(1, 1: Double width × double height)

LE: Character background extension control
(0: Normal, 1: Extended)

LD: Shaded background succeeding line merge control
(0: Independent, 1: Merge with the next line)

LM1, LM0: Line background control
(0, 0: OFF)
(0, 1: Solid-fill display)
(1, 0: Concaved, shaded display)
(1, 1: Convexed, shaded display)

L3 to L0: Line background color
(From among 16 colors)

• Command 5-00 (Screen output control 1A)

Command 5-00 controls screen display output.

15	14	13	12	11	10	9	8	7	6	5	4	3	2	1	0
0	1	0	1	0	0	0	0	SDS	UDS	0	DSP	0	OA2	OA1	OA0

SDS: Sprite character output control
(0: OFF, 1: ON)*

UDS: Screen background output control
(0: OFF, 1: ON)*

DSP: Display output control
(Control of character + trimming + character background + line background)
(0: OFF, 1: ON)*

OA2 to OA0: Output-A character control
(From among eight types)

*: The low level input to the $\overline{\text{RESET}}$ pin initializes the SDS, UDS, and DSP bits to 0.

- **Command 5-01 (Screen output control 1B)**

Command 5-01 controls output-B screen display output.

15	14	13	12	11	10	9	8	7	6	5	4	3	2	1	0
0	1	0	1	0	0	0	1	SOB	BGB	BLB	0	0	OB2	OB1	OB0

SOB: Output-B sprite character output control
(0: OFF, 1: ON)

OB2 to OB0: Output-B character control
(From among eight types)

BGB: Output-B screen background output control
(0: OFF, 1: ON)

BLB : Output-B line background output control
(0: OFF, 1: ON)

- **Command 5-02 (Screen output control 1C)**

Command 5-02 controls output-C screen display output.

15	14	13	12	11	10	9	8	7	6	5	4	3	2	1	0
0	1	0	1	0	0	1	0	SOC	BGC	BLC	0	0	OC2	OC1	OC0

SOC: Output-C sprite character output control
(0: OFF, 1: ON)

OC2 to OC0: Output-C character control
(From among eight types)

BGC: Output-C screen background output control
(0: OFF, 1: ON)

BLC : Output-C line background output control
(0: OFF, 1: ON)

- **Command 5-2 (Vertical display position control)**

This command controls the vertical display position of the screen.

15	14	13	12	11	10	9	8	7	6	5	4	3	2	1	0
0	1	0	1	1	0	0	Y8	Y7	Y6	Y5	Y4	Y3	Y2	Y1	Y0

Y8 to Y0: Vertical display position control
(0 to 1022 in 2-dot units)

- **Command 5-3 (Horizontal display position control)**

This command controls the horizontal display position of the screen.

15	14	13	12	11	10	9	8	7	6	5	4	3	2	1	0
0	1	0	1	1	1	0	X8	X7	X6	X5	X4	X3	X2	X1	X0

X8 to X0: Horizontal display position control
(0 to 1022 in 2-dot units)

- **Command 6-1 (Shaded background frame color control)**

Command 6-1 controls the frame color of a shaded background.

15	14	13	12	11	10	9	8	7	6	5	4	3	2	1	0
0	1	1	0	0	1	0	0	BH3	BH2	BH1	BH0	BS3	BS2	BS1	BS0

BH3 to BH0: Shaded background frame highlight color
(From among 16 colors)

BS3 to BS0: Shaded background frame shadow color
(From among 16 colors)

- **Command 7-3 (Screen background control)**

Command 7-3 controls the screen background color.

15	14	13	12	11	10	9	8	7	6	5	4	3	2	1	0
0	1	1	1	1	1	0	0	0	0	0	0	U3	U2	U1	U0

U3 to U0: Screen background color
(From among 16 colors)

- **Command 8-0 (Sprite character control 1)**

This command controls sprite characters.

15	14	13	12	11	10	9	8	7	6	5	4	3	2	1	0
1	0	0	0	0	0	SFB	SFA	SF3	SF2	SF1	SF0	SC3	SC2	SC1	SC0

SFB, SFA: Sprite character trimming control
(0, 0: Trimming OFF)
(0, 1: Reserved)
(1, 0: Reserved)
(1, 1: Eight-direction trimming)

SF3 to SF0 : Sprite character trimming color
(From among 16 colors)

SC3 to SC0: Sprite character color
(From among 16 colors)

- **Command 8-1 (Sprite character control 2)**

Command 8-1 controls sprite characters.

15	14	13	12	11	10	9	8	7	6	5	4	3	2	1	0
1	0	0	0	0	1	SD1	SD0	SM7	SM6	SM5	SM4	SM3	SM2	SM1	SM0

SD1, SD0: Sprite character configuration control
(0, 0: 1 character)
(0, 1: Reserved (Setting prohibited))
(1, 0: Stack of 2 characters)
(1, 1: Reserved (Setting prohibited))

SM7 to SM0: Sprite character code
(000_H to 0FF_H for 256 different characters)

- **Command 9-0 (Sprite character control 4)**

Command 9-0 controls sprite characters.

15	14	13	12	11	10	9	8	7	6	5	4	3	2	1	0
1	0	0	1	0	0	SY9	SY8	SY7	SY6	SY5	SY4	SY3	SY2	SY1	SY0

SY9 to SY0: Sprite character vertical display position control
(0 to 1023 in 1-dot units)

- **Command 9-1 (Sprite character control 5)**

This command controls sprite characters.

15	14	13	12	11	10	9	8	7	6	5	4	3	2	1	0
1	0	0	1	1	0	SX9	SX8	SX7	SX6	SX5	SX4	SX3	SX2	SX1	SX0

SX9 to SX0: Sprite character horizontal display position control
(0 to 1023 in 1-dot units)

- **Command 11-0 (Screen extension control)**

(Reserved)

15	14	13	12	11	10	9	8	7	6	5	4	3	2	1	0
1	0	1	1	0	0	0	0	0	EG0	0	0	0	0	0	0

EG0: (Reserved)
(0: Normal)*
(1: Reserved (Setting prohibited))

*: Set the EG0 bit to "0".

- **Command 11-2 (Dot clock control 1)**

Command 11-2 controls the dot clock.

15	14	13	12	11	10	9	8	7	6	5	4	3	2	1	0
1	0	1	1	1	0	0	0	0	0	0	0	0	DC2	DC1	DC0

DC2 to DC0: Dot clock selection control
(0, 0, 0: LC oscillation)
(0, 1, 0: External dot clock input)
(0, 1, 1: Frequency-doubled external dot clock input)

• Command 13-0 (I/O pin control)

Command 13-0 controls input/output pins.

15	14	13	12	11	10	9	8	7	6	5	4	3	2	1	0
1	1	0	1	0	0	VVE	VHE	HE	0	SIX	0	0	0	DBX	DCX

VVE: Edge selection for vertical synchronization detection*1
(0: Leading edge, 1: Trailing edge)

VHE: HSYNC edge selection for vertical synchronization detection*1
(0: Leading edge, 1: Trailing edge)

HE: Edge selection for horizontal synchronization operation*1
(0: Trailing edge, 1: Leading edge)

SIX : Logic control for sync signal input
(0: Negative logic, 1: Positive logic)

DCX: Logic control for display color signal output
(0: Positive logic, 1: Negative logic)*3

DBX: Logic control for display output period signal output
(0: Positive logic, 1: Negative logic)*3

*1:When it is set up VVE = 1, VHE = 1 and HE = 1, HSYNC edge for vertical synchronization detection is the standard of "Leading edge".

VVE	VHE	HE	Contents of vertical sync detection	Position of vertical sync detection*3
0	0	0	Detection of VSYNC Leading edge	HSYNC Leading edge
0	0	1	Detection of VSYNC Leading edge	HSYNC Leading edge
0	1	0	Detection of VSYNC Leading edge	HSYNC Trailing edge
0	1	1	Detection of VSYNC Leading edge	HSYNC Trailing edge
1	0	0	Detection of VSYNC Trailing edge	HSYNC Leading edge
1	0	1	Detection of VSYNC Trailing edge	HSYNC Leading edge
1	1	0	Detection of VSYNC Trailing edge	HSYNC Trailing edge
1	1	1	Detection of VSYNC Trailing edge	HSYNC Leading edge + 10 clock

*2:If there is the change of level for direction of VSYNC pin signal detection in the vicinity of position of vertical sync detection, it may occur disorder in the display (deflection of vertical direction) . Input the meaningful edge of VSYNC signal without this position of vertical sync detection.

*3:The low level input to the $\overline{\text{RESET}}$ pin initializes the DCX and DBX bits to 0.

• Command 13-1 (Horizontal blanking control 1)

Command 13-1 controls horizontal blanking (back porch).

15	14	13	12	11	10	9	8	7	6	5	4	3	2	1	0
1	1	0	1	0	1	0	0	0	0	BB5	BB4	BB3	BB2	BB1	BB0

BB5 to BB0: Back porch control
(0 to 126 in 2-dot units)

• Command 13-2 (Horizontal blanking control 2)

Command 13-2 controls horizontal blanking (front porch).

15	14	13	12	11	10	9	8	7	6	5	4	3	2	1	0
1	1	0	1	1	0	0	BF8	BF7	BF6	BF5	BF4	BF3	BF2	BF1	BF0

BF8 to BF0: Front porch control
(0 to 1022 in 2-dot units)

4. Notes on Issuing Commands

This section summarizes notes on issuing commands.

(1) Initialization

The MB90097 enters the display-off state * upon reset input (input of a Low-level signal to the $\overline{\text{RESET}}$ pin). The contents of VRAM (character RAM and line RAM) are not initialized then (undefined immediately after the power supply is turned on).

When the MB90097 is released from the reset input, issue the following commands to initialize control operation:

- Dot clock control 1 (Command 11-2)
- I/O pin control (Command 13-0)

After that, set all of other command data and the contents of VRAM.
(VRAM setting requires normal dot clock and sync signal inputs.)

* : The reset input initializes control bits to 0 as shown below

Screen output control 1A (command 5-00)	SDS = 0	Sprite OFF
	UDS = 0	Screen background OFF
	DSP = 0	Character, character background, line background OFF
I/O pin control (command 13-0)	DCX = 0	Sets the VC0, VC1, VC2, and VC3 pins to positive logic output.
	DBX = 0	Sets the BLKA, BLKB, and BLKC pins to positive logic output.

(2) Command refresh

Command data to the MB90097 and the contents of internal VRAM remain held as long as the MB90097 is powered. If the serial control, sync, and dot clock signals are affected by external noise, however, they may become abnormal signals, preventing the internal registers and VRAM from being set normally. You should therefore refresh all of command data and VRAM data periodically to restore them from the abnormal state.

(3) Command issuance timing

When a VRAM write command, such as a character data setting or line control data setting command, or any other control command is issued, the command is executed immediately, reflecting the result (command setting) on the screen. When such a command is issued during a display period, the display in the relevant field may involve transient distortion. To prevent this, you should issue the command during the vertical blanking interval. Also, a restriction on the internal circuit configuration may cause deviation of the display position in the first display field when the DSP, SDS, or UDS control bit of command 5-00 (screen output control 1A) is set from OFF to ON. To prevent this, you should issue command 5-00 within the 2H period after the leading edge of the V sync signal.

■ DISPLAY FUNCTIONS

1. Screen Configuration

1.1 Screen Elements

The display screen provided by the MB90097 consists of a pile of display screen elements.

	Display screen element name	Display configuration	Display position control
Top layer ↑	Sprite character (+ trimming)	1 (Stack of 2 characters)	Horizontal/vertical: 1-dot units
	Character (+ trimming)	28 characters × 12 lines	Horizontal/vertical: 2-dot units
	Character background	28 characters × 12 lines	(Controlled simultaneously with the character)
	Line background	12 lines	(Controlled simultaneously with the character)
↓ Bottom layer	Screen background	Full screen display in single color	(None)

• Screen configuration drawing

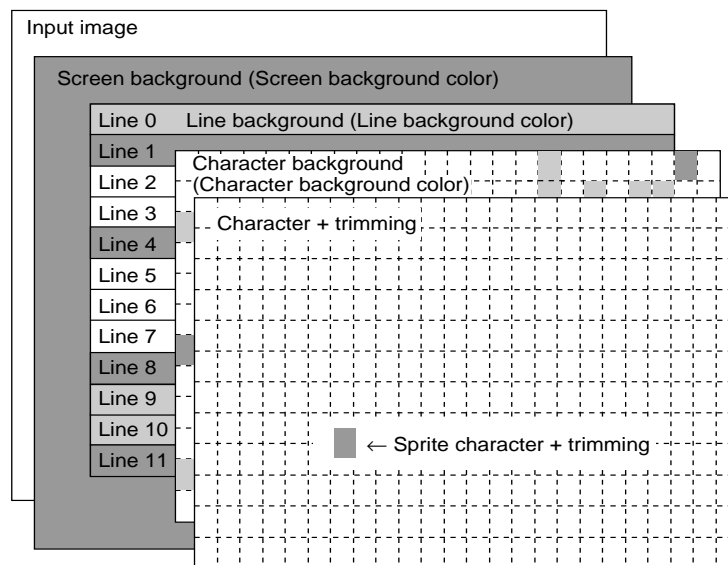

Note: When a character is displayed on a line, the display of the shaded background shadow frame for the line background overrides the character display.
The display of the shaded background shadow frame for the character background overrides the character display and the shaded background shadow frame for the line background.

1. 2 Screen Display Modes

Display screen element name	Display mode							
Screen background	Undisplay							
	Display							
Line background	Undisplay						Line spacing (0 to 7 dots)	
	Solid-fill display							
	Shaded background concaved display			Shaded background succeeding line merge	Independent			
	Shaded background convexed display			Merge				
Character background	Undisplay							
	Solid-fill display						Character background extended (enabled with line spacing)	
	Shaded background concaved display	Shaded background succeeding character merge	Independent	Shaded background succeeding line merge	Independent			Normal
	Shaded background convexed display		Merge		Merge			Extended
Character	Undisplay (blank character (Arbitrarily set))							
	Display	Trimming output control	Undisplay				Trimming type	Undisplay
			Display for characters with no character background					
			Display for characters with no character background or with solid-filled character background			Eight-direction trimming display		
Display for all characters								
Sprite character	Undisplay							
	Display	Consisting of a single character			Trimming type	Undisplay		
Consisting of a stack of characters			Eight-direction trimming display					

1.3 Screen Output Control

The screen output control commands can control three channels of outputs A, B, and C independently. Their output enable period signals are output to the BLKA, BLKB, and BLKC pins, respectively.

The output-A, -B, and -C control commands can set the character attribute display to OFF, line background display, and screen background display arbitrarily based on the basic display screen, allowing three independent screens to be configured and output.

The layer structure of the output screens exists only on the basic display screen. If the output-A, -B, or -C control command sets the display of an arbitrary area to OFF, the lower layer cannot be displayed but appears transparent.

The table below shows the relationships between screen output controls and control command bits.

Basic display screen control	Three-channel output controls		
Elements to be controlled/Control bit name (Unit of control)	Output-A control	Output-B control	Output-C control
Character + trimming + character background + line background DSP (per screen)	←	←	←
Character + trimming + character background LDS (per line)	←	←	←
Character M8-M0 (per character)	OA2-OA0 (per screen) × MO1, MO0 ^{*1} (per character)	OB2-OB0 (per screen) × MO1, MO0 ^{*1} (per character)	OC2-OC0 (per screen) × MO1, MO0 ^{*1} (per character)
Character trimming LFD-LFA (per line)			
Character background MM1, MM0 (per character)			
Line background LM1, LM0 (per line)	←	BLB ^{*2} (per screen)	BLC ^{*2} (per screen)
Screen background color UDS (per screen)	←	BGB (per screen)	BGC (per screen)
Sprite character SDS (per screen)	←	SOB ^{*3} (per screen)	SOC ^{*3} (per screen)
Sprite character trimming SFB, SFA (per screen)	←		

*1: If character display is set to OFF with the character/trimming/character background overlapping the line background or screen background, the corresponding area of the lower layer is not displayed but appears transparent.

*2: If line background display is set to OFF with the line background overlapping the screen background, the corresponding area of the screen background is not displayed but appears transparent.

*3: If sprite display is set to OFF with the sprite character/trimming overlapping a character, character background, line background, or screen background, the corresponding area of the lower layer is not displayed but appears transparent.

Note: Three-channel output control for each character serves as output control within the character area. When trimming dots for a character are displayed in part of the area for an adjacent character, the output of the trimming dots is controlled by the output control of that adjacent character. If there are trimming dots to the left of the leftmost character on a line, they cannot be controlled by three-channel output control for each character. In this case, set a blank character at the left end of the line.

When trimming dots are displayed to the right of the rightmost character on a line, they are controlled with the three-channel output attribute of the rightmost character.

1.4 Screen Display Position Control

(1) Display position control on the character screen

The MB90097 can simultaneously control the display start positions of a character (or a line of characters), character trimming, character background, and line background.

- Vertical display position: Vertical display position control (command 5-2), Bits Y8 to Y0
Set the vertical display start position* relative to the VSYNC position.
The position can be set between 0 and 1022 dots in 2-dot units.
- Horizontal display position: Horizontal display position control (command 5-3), Bits X8 to X0
Set the vertical display start position* relative to the HSYNC position.
The position can be set between 0 and 1022 dots in 2-dot units.
- Line spacing: Line control data setting 1 (command 3), Bits LW2 to LW0
Set the number of dots to specify the height of the areas to be kept above and below the characters on each line.
The spacing specified by the set value will be kept both above and below the characters.
The line spacing can be set between 0 and 7 dots in 1-dot units for each line.
(Note: When line double-height display is on, the line spacing is doubled as well.)

*: The actual display position is offset from the set value by several tens of dots in the positive direction.

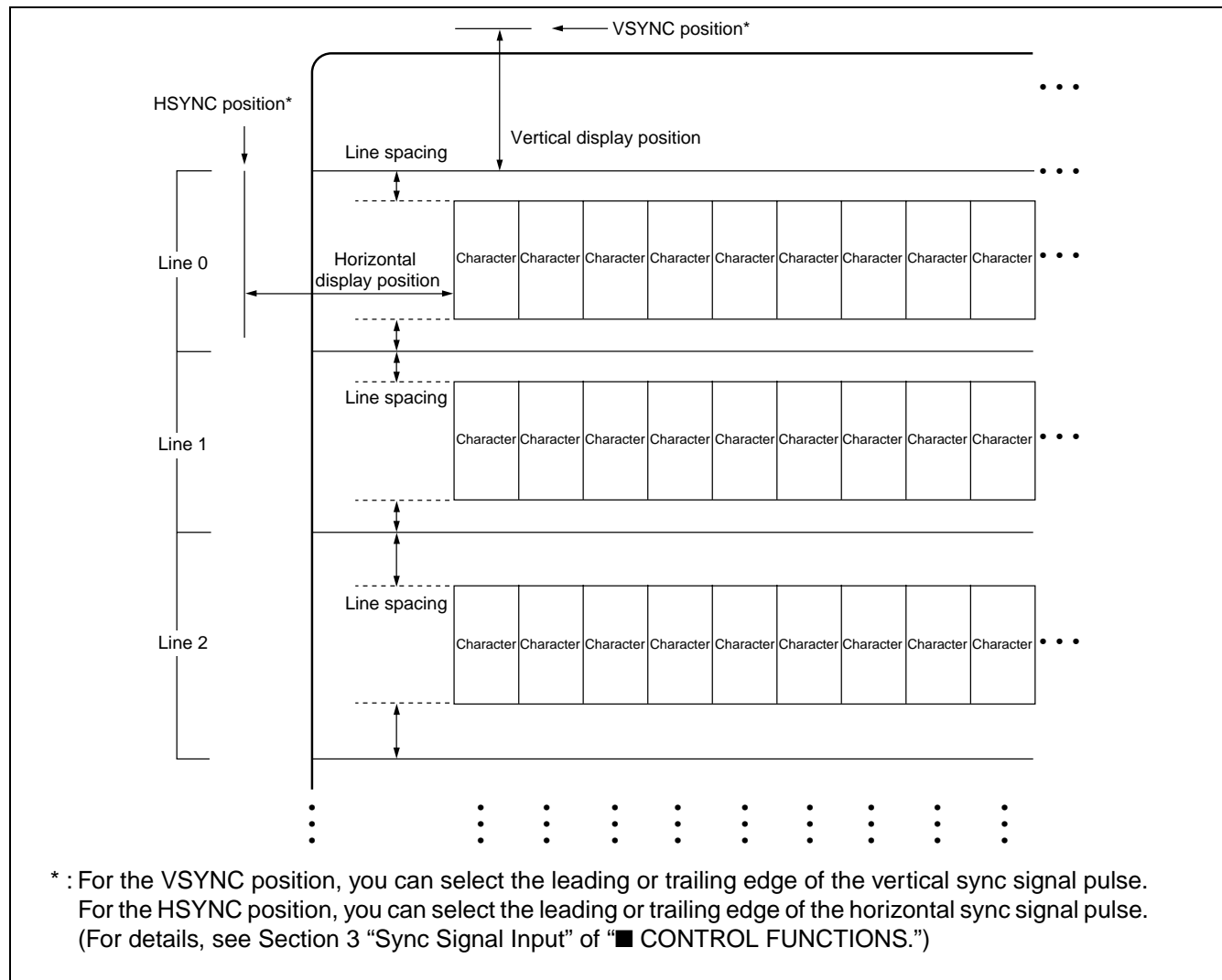

(2) Display position control of sprite characters

The MB90097 can control the display start positions of a sprite character and its trimming.

- Sprite character vertical display position: Sprite character control 4 (command 9-0), Bits SY9 to SY0
Set the vertical display start position* relative to the VSYNC position.

The position can be set between 0 and 1023 dots in 1-dot units.

- Sprite character horizontal display position: Sprite character control 5 (command 9-1), Bits SX9 to SX0
Set the vertical display start position* relative to the HSYNC position.

The position can be set between 0 and 1023 dots in 1-dot units.

*: The actual display position is offset from the set value by several tens of dots in the positive direction.

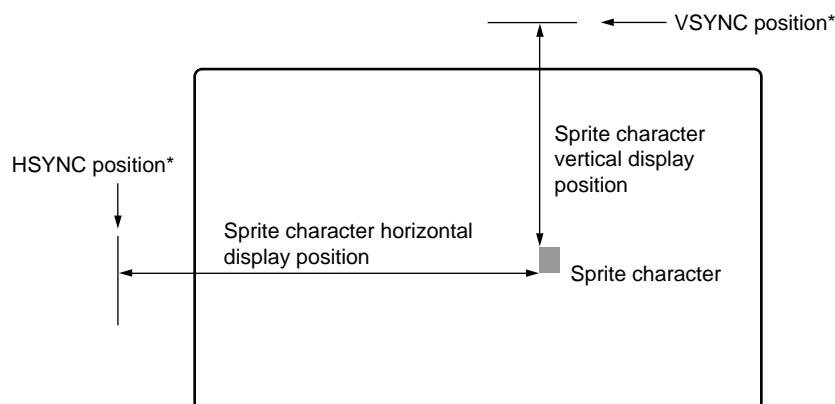

* : For the VSYNC position, you can select the leading or trailing edge of the vertical sync signal pulse.
For the HSYNC position, you can select the leading or trailing edge of the horizontal sync signal pulse.
(For details, see Section 3 "Sync Signal Input" of "■ CONTROL FUNCTIONS.")

2. Font ROM Configuration

The font ROM can incorporate 512 characters each made up of 12×18 dots.

- All of 512 characters can be set freely by the user.
(Note, however, that the blank character must be set as an arbitrary character code because even it is not set by default.)
- The user areas available to sprite characters are from 000H to 0FFH.

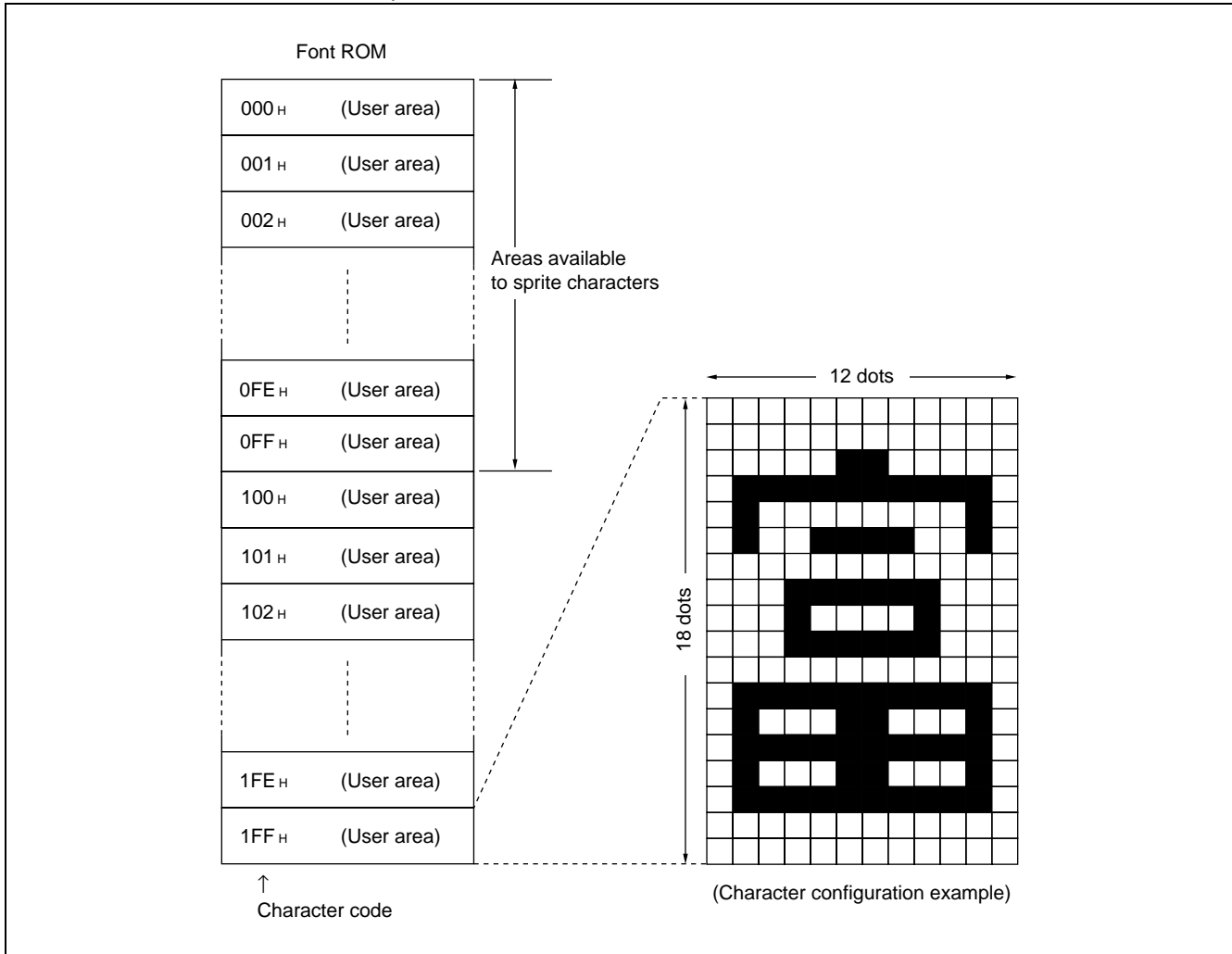

3. Display Memory (VRAM) Configuration

The display memory (VRAM) consists of the character RAM for setting individual characters and the line RAM for setting individual lines.

- Character RAM: 28 characters × 12 lines (336 characters in total)
- Line RAM: 12 lines

3.1 Display Memory and Display Screen

Areas of character RAM and those of line RAM correspond to displayed characters and lines on a one-to-one basis, respectively.

- Display memory configuration

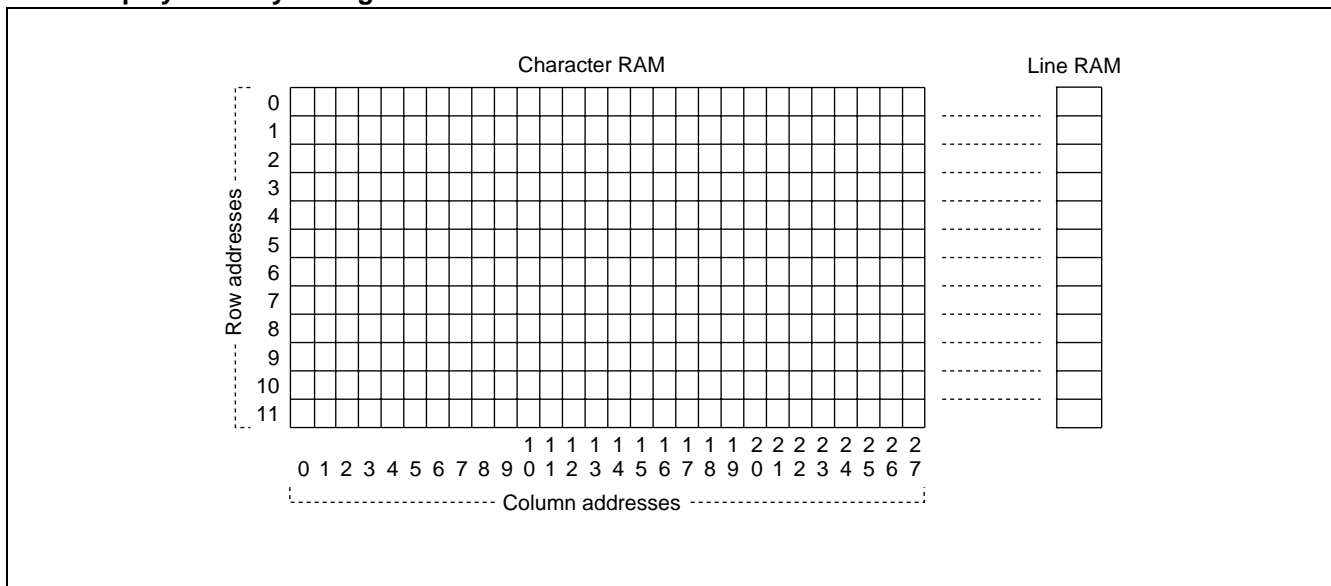

- Example of display screen configuration (with all characters in normal size)

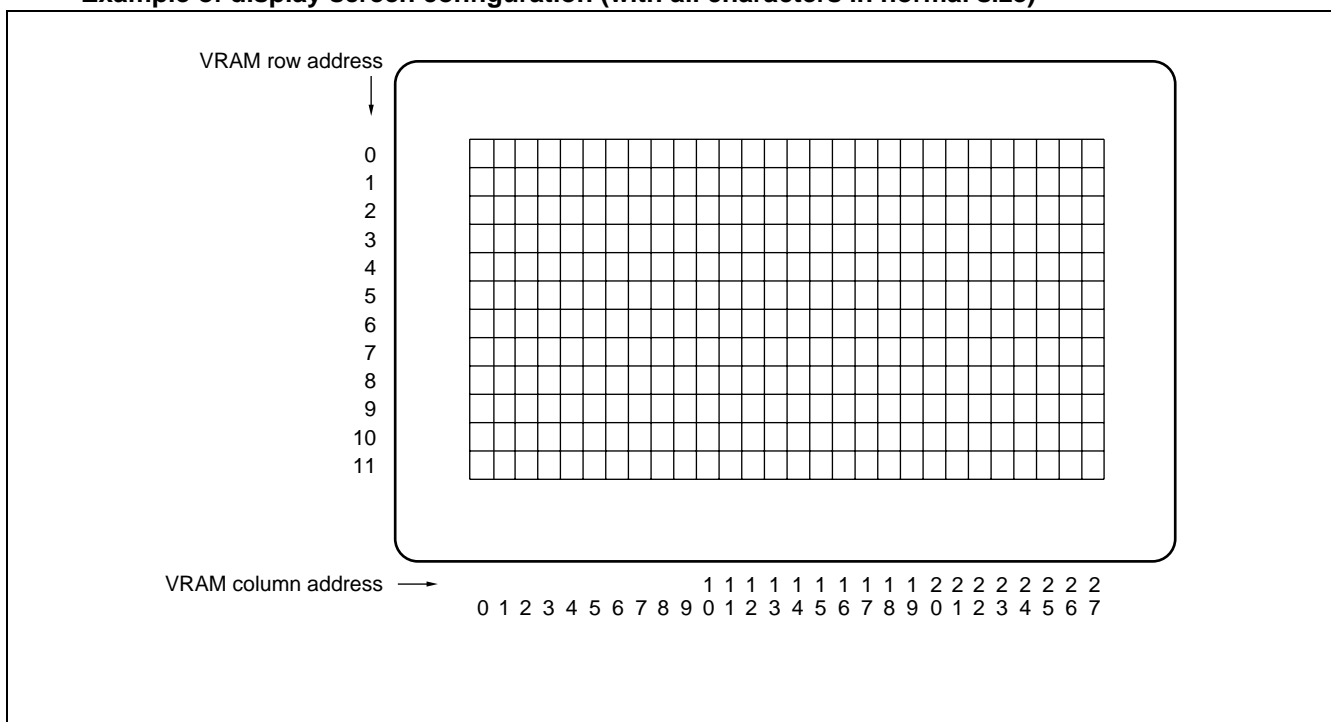

3.2 Writing to Display Memory

(1) Writing characters to character RAM

a) Writing a single character

Use the following commands to write data on an arbitrary character to an arbitrary address in character RAM:

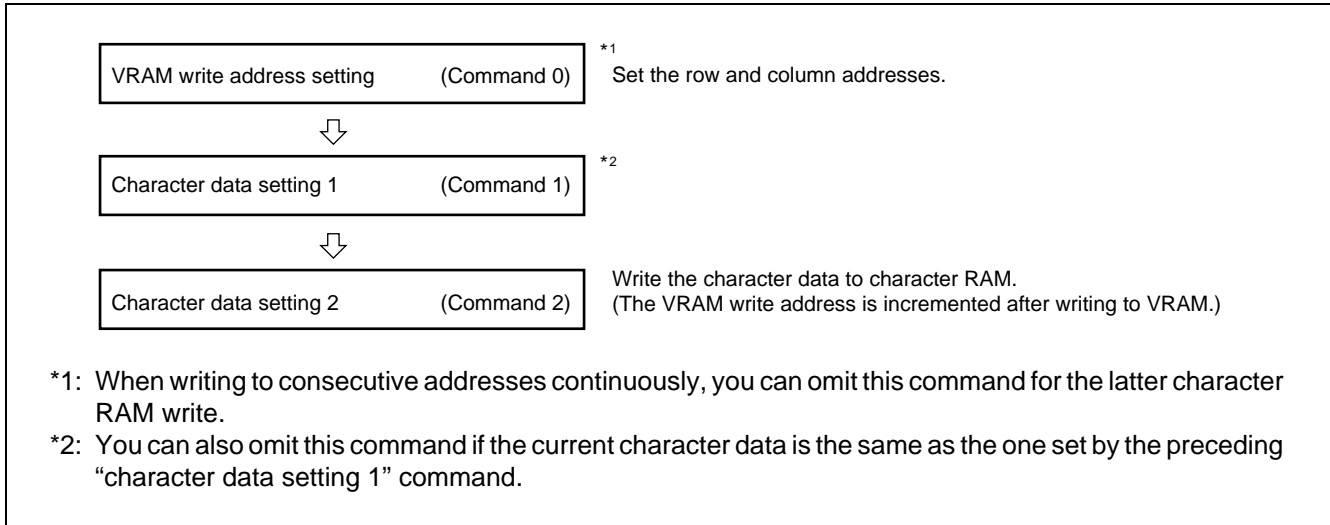

Note: Normal writing to VRAM requires input of a normal horizontal sync signal. Input of an invalid horizontal sync signal may cause VRAM write to fail.

Also, you must set the horizontal sync signal pulse width and VRAM write cycle (command 2 or command 4 issuance cycle) such that: horizontal sync signal pulse width < VRAM write cycle.

b) Writing multiple characters collectively (VRAM fill)

Use the following commands to write data on an arbitrary character to an area of character RAM from an arbitrary address to the last address, filling the area with that data:

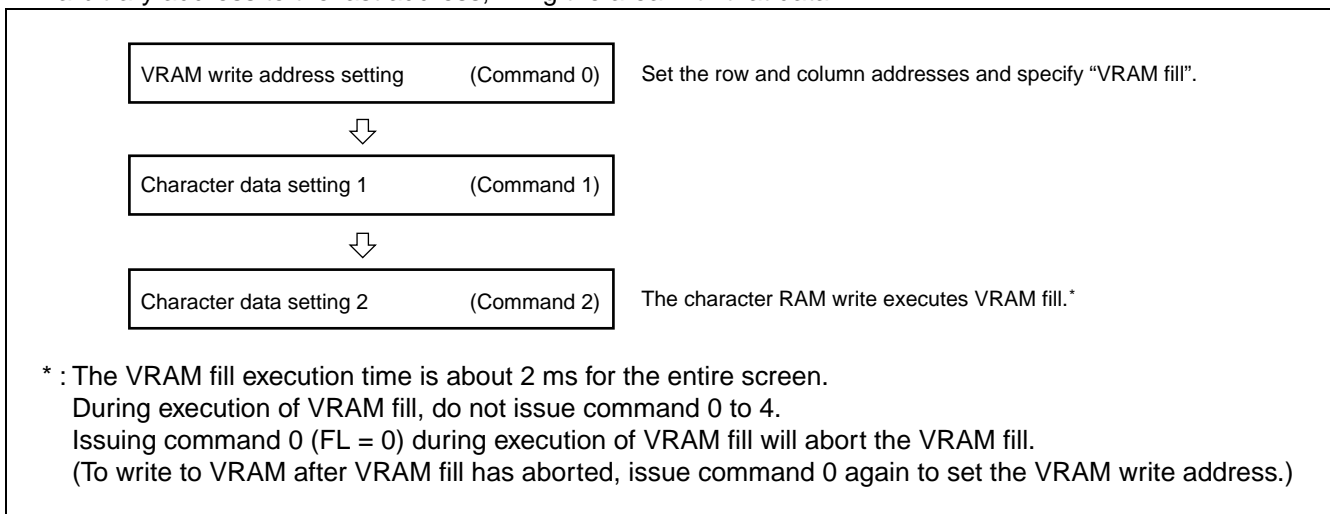

Note: Normal execution of VRAM fill requires input of a normal horizontal sync signal. Input of an invalid horizontal sync signal may cause VRAM fill to fail.

(2) Writing to line RAM

Use the following commands to write data on an arbitrary line to an arbitrary address in line RAM:

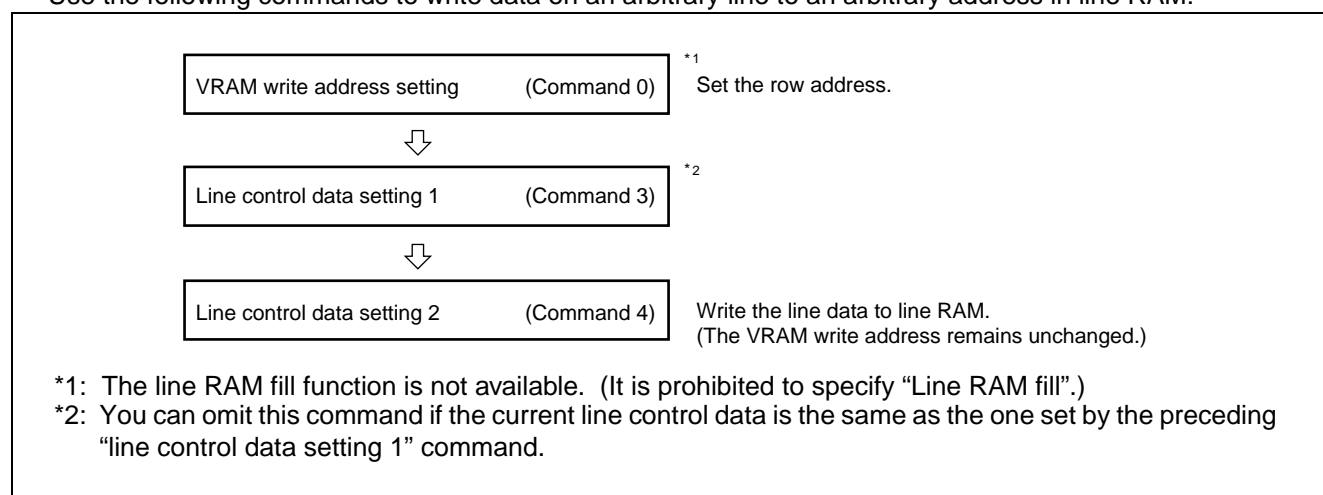

Note: Normal writing to VRAM requires input of a normal horizontal sync signal. Input of an invalid horizontal sync signal may cause VRAM write to fail.

Also, you must set the horizontal sync signal pulse width and VRAM write cycle (command 2 or command 4 issuance cycle) such that: horizontal sync signal pulse width < VRAM write cycle.

4. Character Display

4.1 Displayed Character Configuration

For each character to be displayed, you can set the vertical and horizontal sizes.

Each character is displayed by clipping the specified size of the specified character data from font ROM, starting at the upper leftmost dot.

- Character horizontal size control (Setting for each character)

Character data setting 1 (Command 1): Bits MS1 and MS0

MS1	MS0	Character horizontal size
0	0	S size: 6 dots
0	1	M size: 9 dots
1	0	L size: 12 dots
1	1	(Setting prohibited)

- Line character vertical size type control (Setting for each line)

Line control data setting 1 (Command 3): Bit LHS

LHS	Line character vertical size type
0	Line character vertical size A: 18 dots
1	Line character vertical size B: 12 dots

- Display examples

- A character stored in font ROM

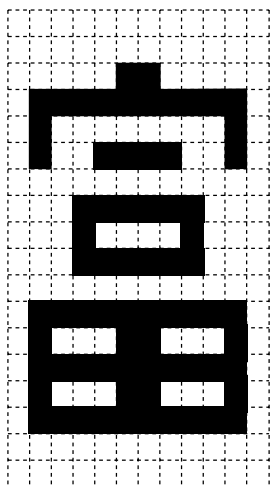

(12 horizontal dots × 18 vertical dots)

- Display example 1 (character vertical size A: 18 dots)

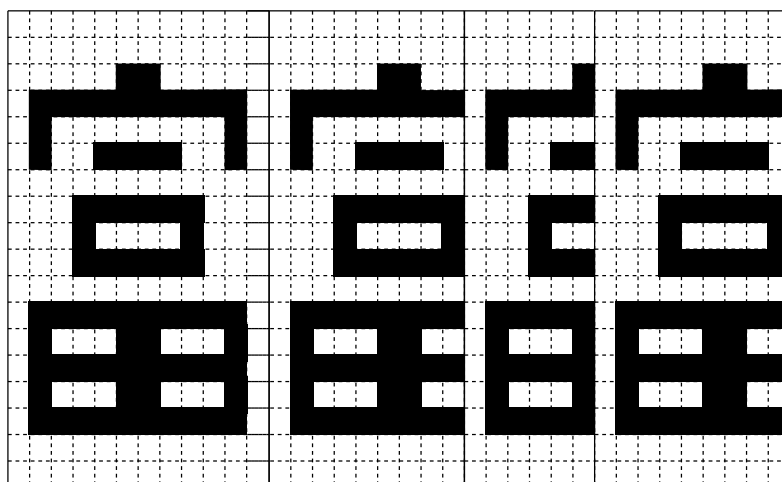

L size

M size

S size

M size

- Display example 2 (character vertical size B: 12 dots)

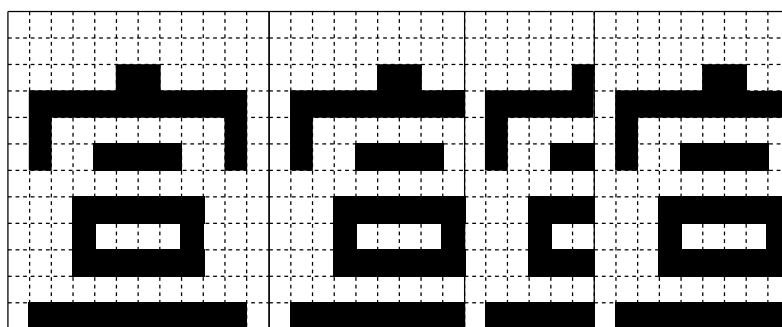

L size

M size

S size

M size

4. 2 Character Trimming

(1) Trimming output control

Trimming output control turns ON or OFF the trimming of characters depending on their character background type. One of the four character background types can be set for each line.

- Trimming output control (Setting for each line)

Line control data setting 1 (Command 3): Bits LFD and LFC

Trimming output control (Setting for each line)		Character background type (Setting for each character)			Trimming output
LFD	LFC	MM1	MM0	Background display	
0	0	0	0	Undisplay	×
		0	1	Solid-filled background	×
		1	0	Concaved, shaded background	×
		1	1	Convexed, shaded background	×
0	1	0	0	Undisplay	○
		0	1	Solid-filled background	×
		1	0	Concaved, shaded background	×
		1	1	Convexed, shaded background	×
1	0	0	0	Undisplay	○
		0	1	Solid-filled background	○
		1	0	Concaved, shaded background	×
		1	1	Convexed, shaded background	×
1	1	0	0	Undisplay	○
		0	1	Solid-filled background	○
		1	0	Concaved, shaded background	○
		1	1	Convexed, shaded background	○

× : Undisplay
○ : display

(2) Trimming type control

As the type of trimming, you can select “eight-direction trimming” or “undisplay”.

- Trimming type control (Setting for each screen)

Line control data

setting 1 (Command 3): Bits LFB and LFA

Trimming output control		Trimming output
LFB	LFA	
0	0	Undisplay
0	1	Reserved (Setting prohibited)
1	0	Reserved (Setting prohibited)
1	1	Eight-direction trimming

(3) Trimming colors

The trimming color can be set to one of 16 different colors for each line.

- Trimming color (Setting for each line, selected from among 16 colors)
Line control data setting 1 (Command 1): Bits LF3 to LF0

(4) Trimming display rules

The following display rules apply to trimming display:

- Trimming dots for a character can be displayed in the right or left adjacent character area only when the character background types of the two characters are the same.
- Trimming dots for the character at the left or right end of a line can be displayed beyond the character area only when the character background type is “no character background”.
(When three-channel output control for each character is used, however, do not attempt to display trimming dots outside the character area at the left end of a line. Trimming dots for that area cannot be controlled in character units. Note also that trimming dot display outside the character area at the right end of a line depends on the character output control setting for the rightmost character on the line.)
- Trimming display for a character does not apply to the areas above and below the character (the area for the character on the line above, the area for the character on the line below, the upper line spacing, and the lower line spacing).
- When a line is displayed enlarged, trimming dots on the line are not enlarged but those in the normal dot size are displayed around the enlarged character dots.

Note: For output control of each character using three-channel output control, design the display and font taking account of trimming dot display protruding to the area for the adjacent character to the right or left. Three-channel output control for each character is display output control of the character area. Turning on or off the display of trimming dots protruding to the right or left adjacent character area depends on the character output control setting for that adjacent character.

4.3 Line Enlarged Display

Line enlarged display control is used to control the display size of each line including the characters, character backgrounds, and line background on that line (as well as the line spacing portions). This also controls enlargement of the shadow frames of shaded backgrounds. It does not however control the enlargement of the trimming dot width.

Note that the lines and characters following the line for which line enlarged display has been specified are shifted down accordingly.

- **Line enlargement control (Setting for each line)**

Line control data setting 2 (Command 4): Bits LG1 and LG0

LG1	LG0	Display size
0	0	Normal size
0	1	Double-width size
1	0	Double-height size
1	1	Double-width/height size

(1) Line enlarged display examples

- **Normal size**

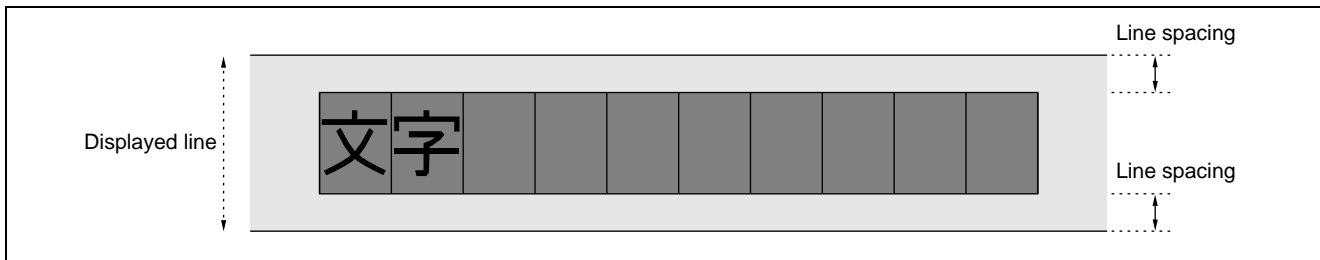

- **Double-width size**

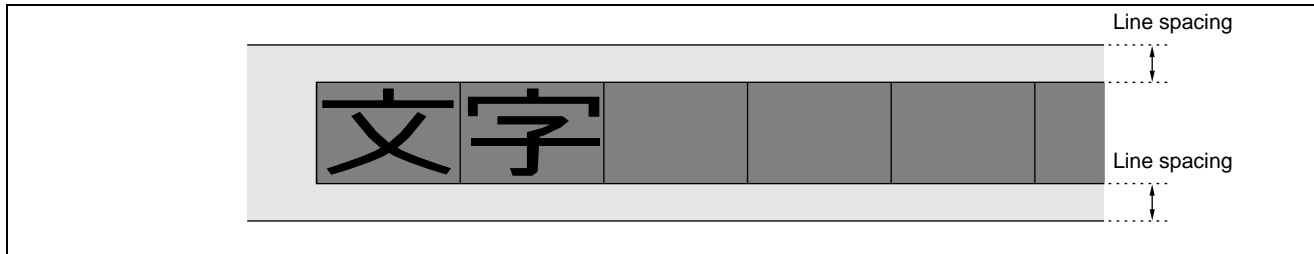

- **Double-height size**

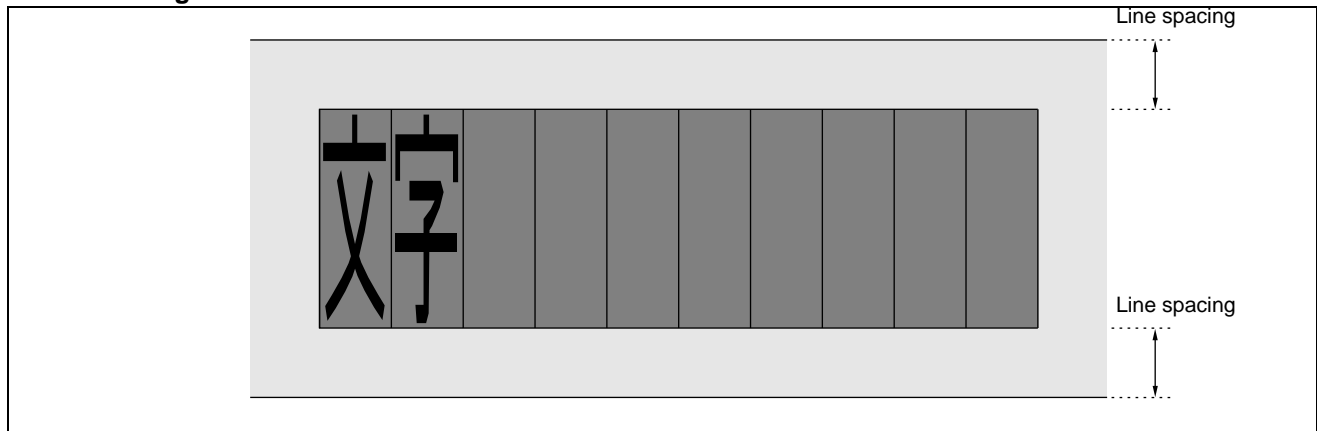

- **Double-width/height size**

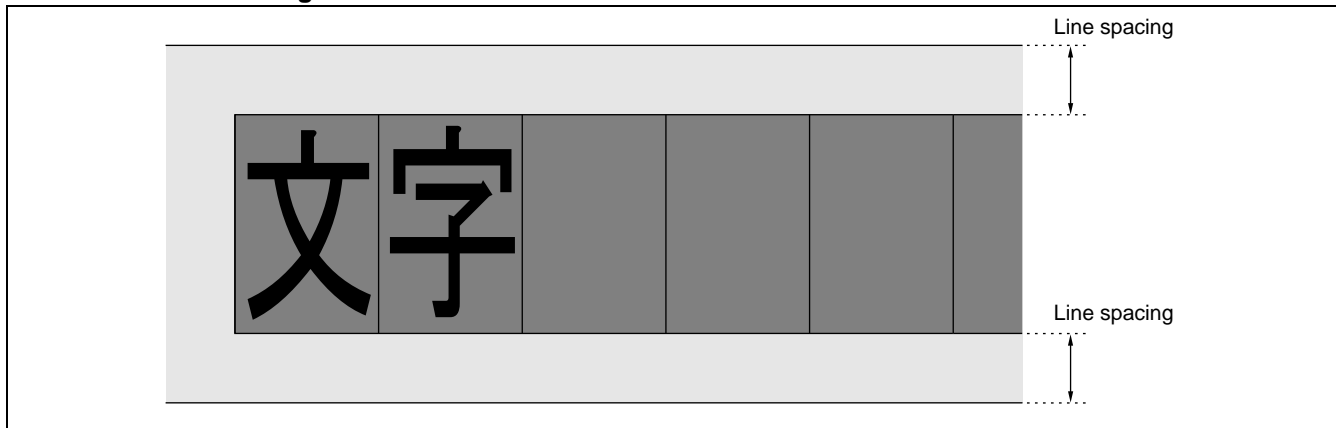

(2) Dot interpolation for enlarged display

Dot interpolation display is enabled only when the line enlargement control is in the double-width size display. You can designate the display in line units.

Dot interpolation is performed in character units; dots are not interpolated between the neighboring characters. Outline display is generated and displayed in the character dots and interpolation dots. Outline dot width is not displayed enlarged.

- **Line enlargement interpolation control (Setting for each line)**

Line control data setting 2 (Command 4): Bit LGS

LGS	Interpolation control
0	Interpolation OFF
1	Interpolation ON

- **Interpolated display examples (Basic type)**

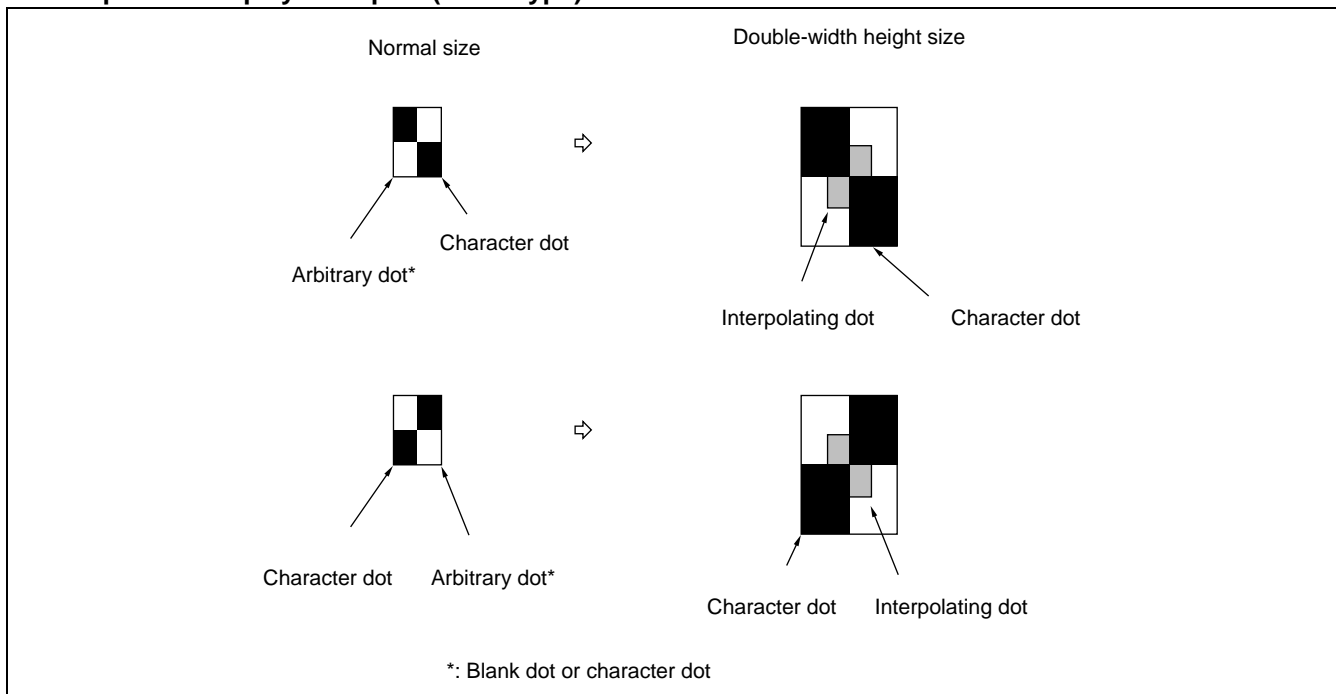

5. Character Background Display

5.1 Character Background Display

For each character, you can set the character background selected from among four types and the character background color from among 16 colors.

- **Character background control (Setting for each character)**

Character data setting 1 (Command 1) :
Bits MM1 and MM0

MM1	MM0	Character background
0	0	NO background (undisplay)
0	1	Solid-filled background
1	0	Concaved, shaded background
1	1	Convexed, shaded background

- **Character background color (Setting for each character, selected from among 16 colors)**

Character data setting 1 (Command 1) :
Bits MB3 to MB0

Note: The character background color is transparent when all of MB3 to MB0 have been set to 0.

(If character background display has been set for a character with the above settings, the corresponding portion of the lower layer will be displayed.)

- **Shaded background highlight color (Setting for each screen, selected from among 16 colors)**

Shaded background frame color control (Command 6-1) :
Bits BH3 to BH0

- **Shaded background shadow color (Setting for each screen, selected from among 16 colors)**

Shaded background frame color control (Command 6-1) :
Bits BS3 to BS0

- **Display examples**

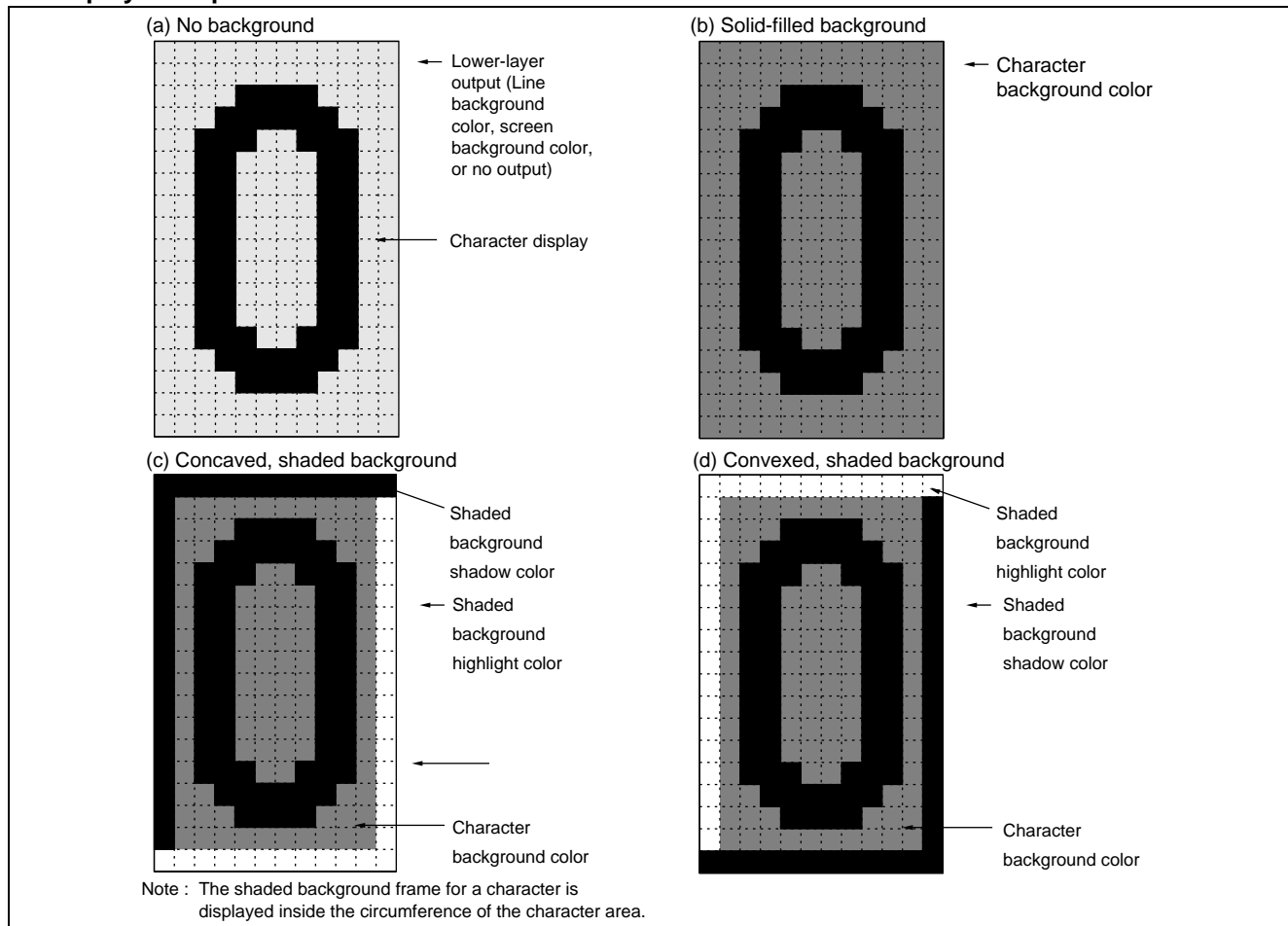

5.2 Shaded Background Succeeding Character Merge Display

Specifying “shaded background character display” and “shaded background succeeding character merge display” for a character undisplay the right line of the shadow frame of the character and the left line of the shadow frame of the next (right adjacent) character. This enables two or more characters with shaded backgrounds to be joined horizontally.

- **Shaded background succeeding character merge control (Setting for each character)**

Character data setting 2 (Command 2) : Bit MR

MR	Shaded background succeeding character merge control
0	OFF
1	ON

- **Display examples of independent characters with shaded backgrounds**

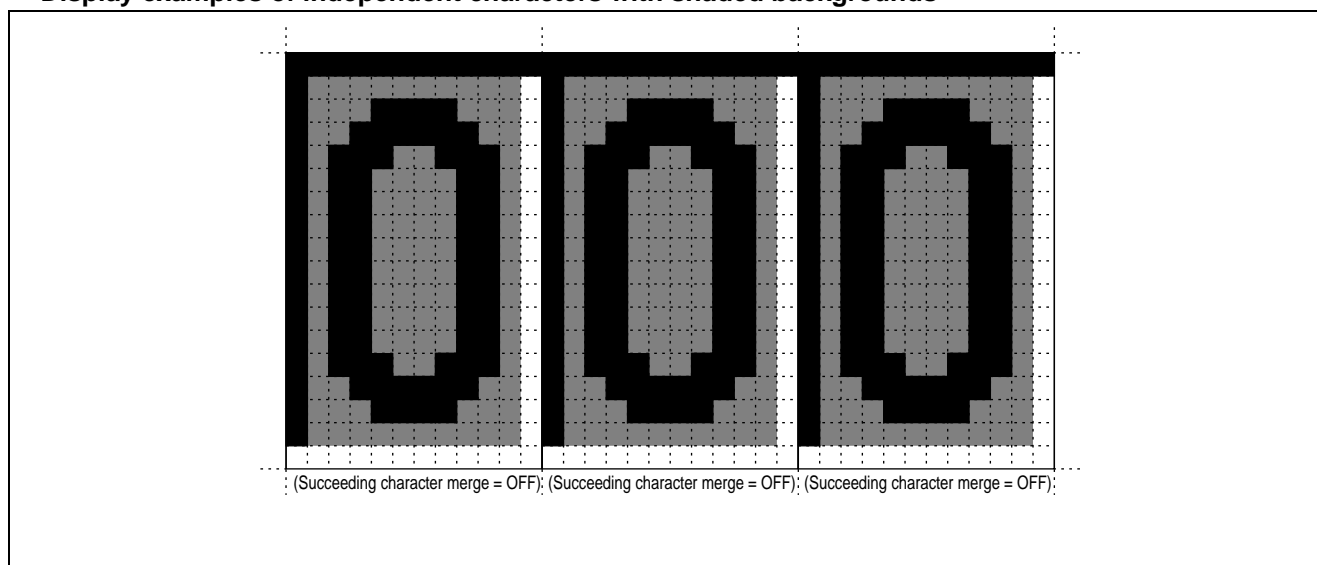

- **Display examples of merged characters with shaded backgrounds**

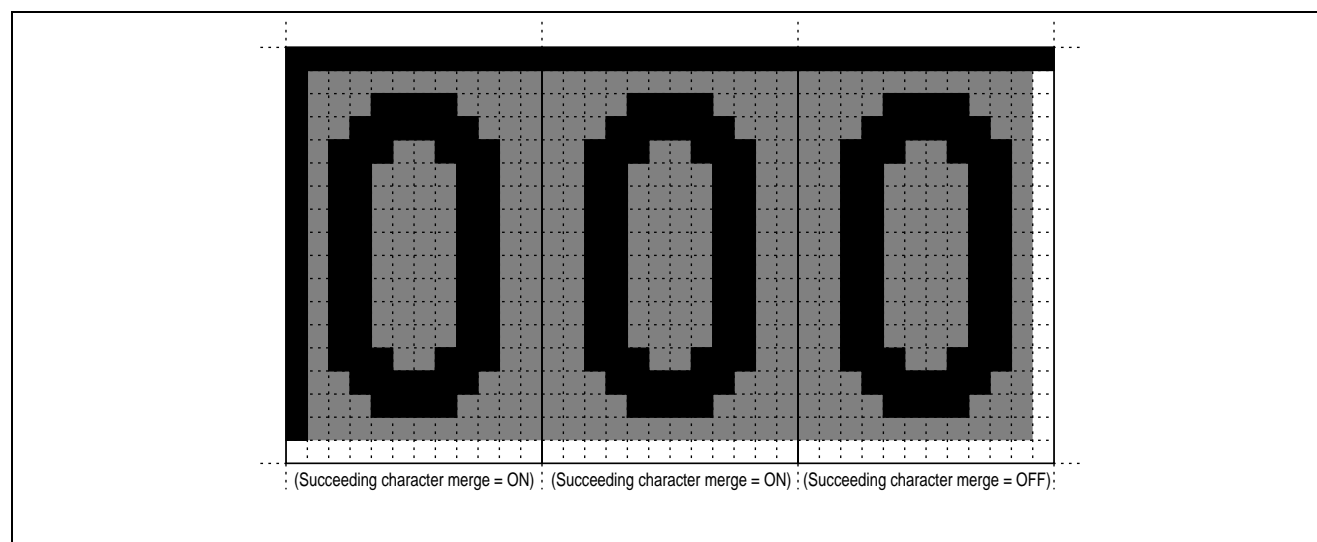

5.3 Shaded Background Succeeding Line Merge Display

Specifying “shaded background character display” for characters on a line and both of “character background extended display” and “shaded background succeeding line merge display” for the line undisplay the lower lines of the shadow frames of the characters on that line and the upper lines of the shadow frames of the characters on the next line. (Specify both of “shaded background succeeding line merge display” and “character background extended display” for the current line and “character background extended display” for the next line.)

- **Shaded background succeeding line merge control (Setting for each line)**
- **Character background extended display control (Setting for each line)**

Line control data setting 2 (Command 4) :
Bit LD

Line control data setting 2 (Command 4) :
Bit LE

LD	Shaded background succeeding line merge control
0	OFF
1	ON

LE	Character background extended display control
0	OFF (Normal display)
1	ON (Extended display)

- **Display examples of merged lines of characters with shaded backgrounds**

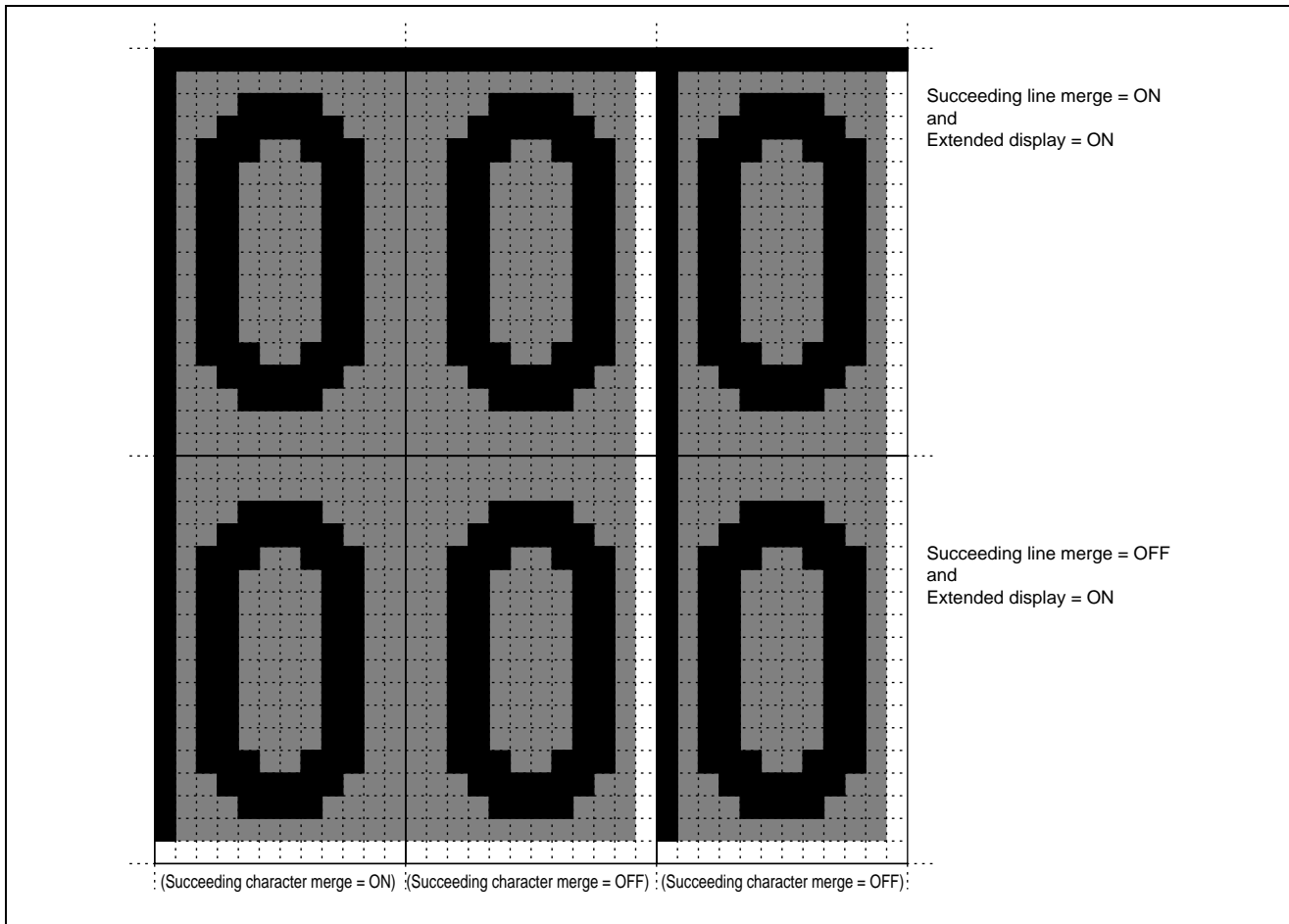

Note: If character background extended display is not specified, shaded background succeeding line merge display is disabled for character backgrounds. (The setting of shaded background succeeding line merge display applies only to the line background shadow frame.)

5.4 Character Background Extended Display

Character background extended display extends character backgrounds to line spacing portions.
 (Note that this setting is required to apply shaded background succeeding line merge display to character backgrounds.)

- **Character background extended display (Setting for each line)**

Line control data setting 2 (Command 4): Bit LE

LE	Character background extended display
0	OFF (Normal display)
1	ON (Extended display)

- **Display example with character background extended display = OFF (Line spacing = 2)**

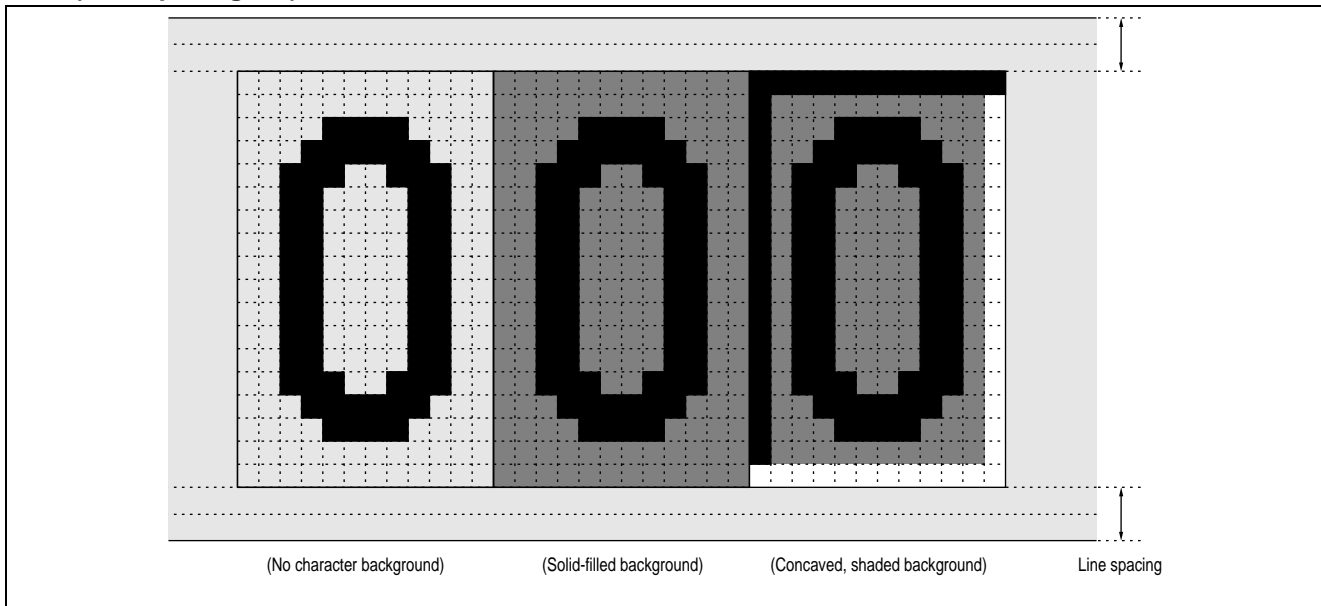

- **Display example with character background extended display = ON (Line spacing = 2)**

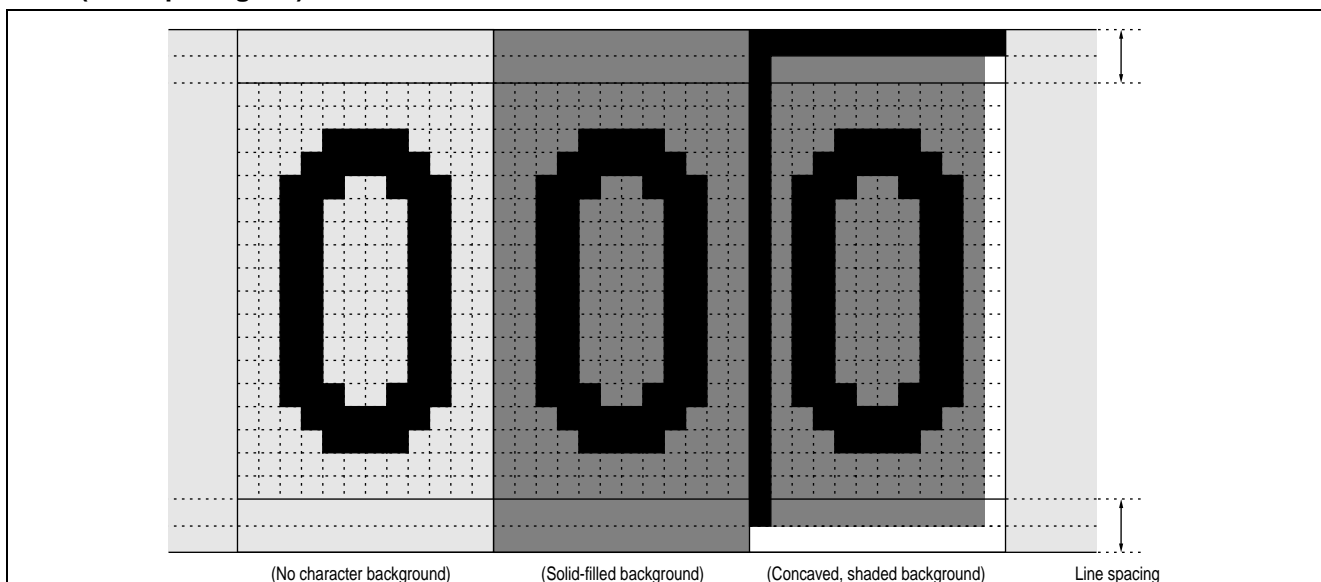

6. Line Background Display

6.1 Line Background Display

Line background display for a line displays the line background in the line area of the characters on the line, the areas to the right and left of that area, and the line spacing areas above and below it.

There are four types of line backgrounds available (None, Solid fill, Concaved shaded background, and Convexed shaded background), one of which can be set for each line.

Shaded line background display is used to display the shaded background frame highlight color and shaded background frame shadow color above and below the line background area, respectively, along with the line background color display.

- **Line background control (Setting for each line)**

Line control data setting 2 (Command 4) :
Bits LM1 and LM0

LM1	LM0	Line background
0	0	No background (undisplay)
0	1	Solid-filled background
1	0	Concaved, shaded background
1	1	Convexed, shaded background

- **Line background color**

(Setting for each line, selected from among 16 colors)

Line control data setting 2 (Command 4) :
Bits L3 to L0

- **Shaded background highlight color**

(Setting for each screen, selected from among 16 colors)

Shaded background frame color control (Command 6-1) :
Bits BH3 to BH0

- **Shaded background shadow color**

(Setting for each screen, selected from among 16 colors)

Shaded background frame color control (Command 6-1) :
Bits BS3 to BS0

- **Line background display examples**

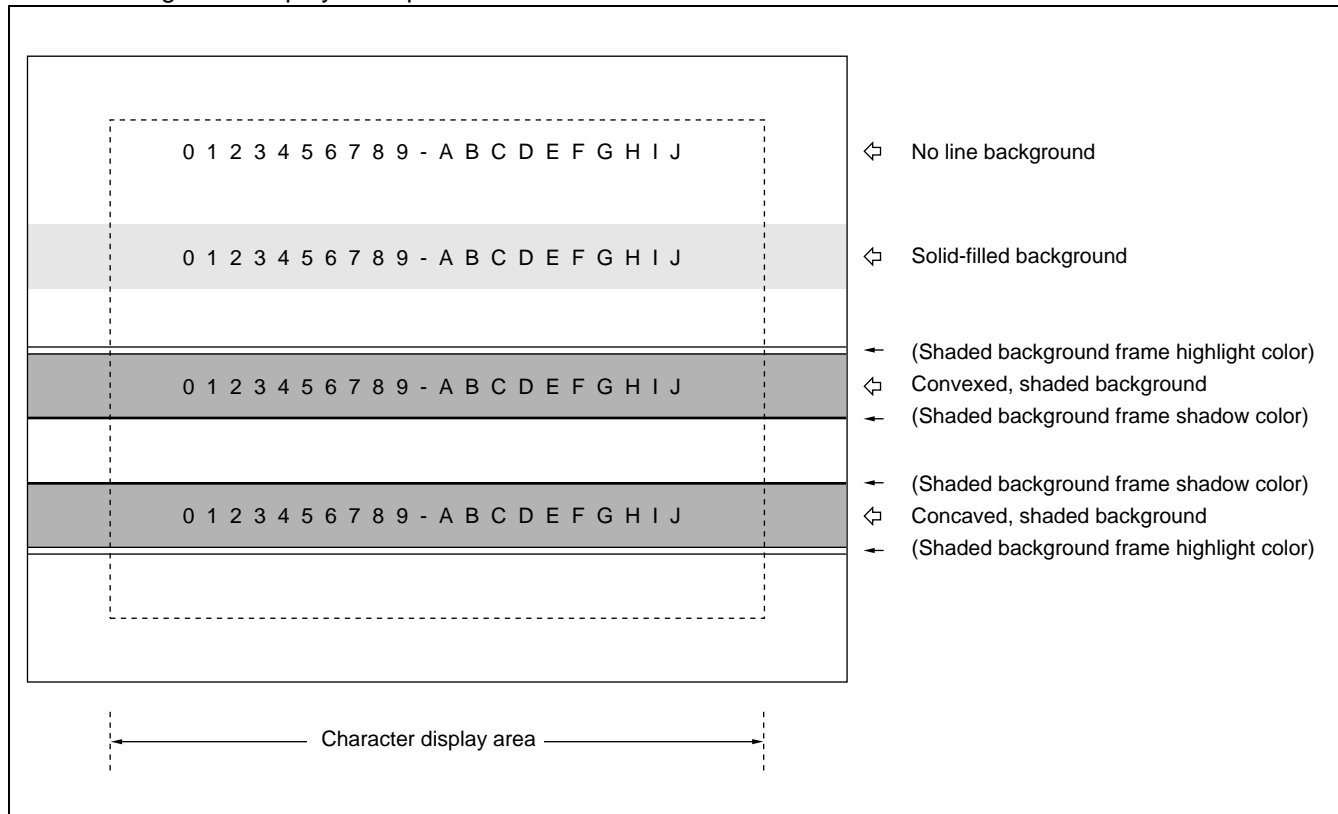

6.2 Shaded Background Succeeding Line Merge Display

Specifying “shaded background succeeding line merge display” for a line enables the line to be displayed with the line background merged with that of the next line.

This undisplay the lower line of the line background shadow frame of the current line and the upper line of the line background shadow frame of the next line, allowing two or more lines to be displayed with shaded line backgrounds.

- **Shaded background succeeding line merge control (Setting for each line)**

Line control data setting 2 (Command 4): Bit LD

LD	Shaded background succeeding line merge control
0	OFF
1	ON

- **Examples of shaded background succeeding line merge display**

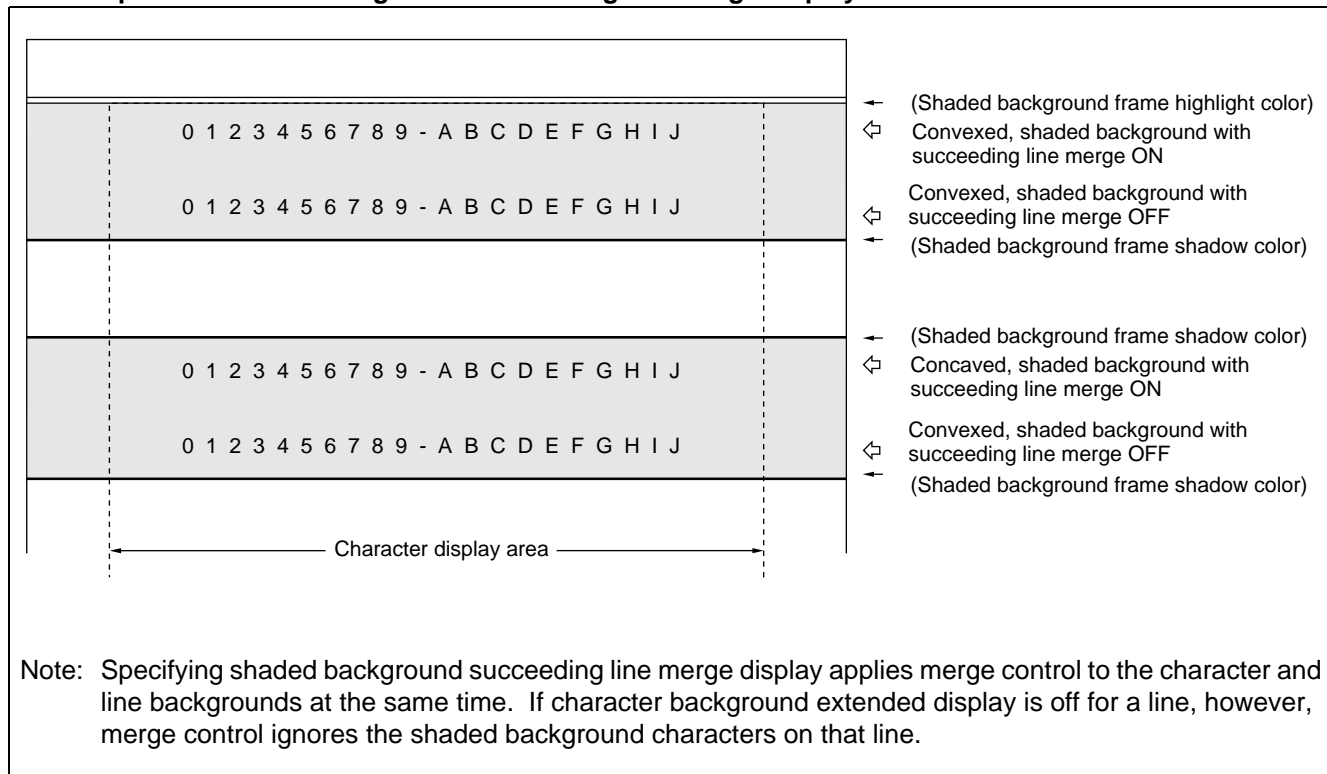

7. Screen Background Display

7.1 Screen Background Color Display

The screen background color can be output to the bottom layer of display output.

- **Screen background output control**

Screen output control 1A (Command 5-00): Bit UDS

UDS	Screen background color display
0	OFF
1	ON

- **Screen background color code**

Screen background control 4 (Command 7-3): Bits U3 to U0

One of 16 colors can be set.

- **Three-channel output control**

When screen background color output is ON (UDS = 1), the screen background outputs to output B and output C can be controlled independently. (Output A is controlled only with the UDS bit.)

- **Output-B screen background color output control**

Screen output control 1B (Command 5-01): Bit BGB

BGB	Output-B screen background color output
0	OFF
1	ON*

- **Output-C screen background color output control**

Screen output control 1C (Command 5-02): Bit BGC

BGC	Output-C screen background color output
0	OFF
1	ON*

* : Enabled only when screen background color output is ON (UDS = 1).

8. Sprite Character Display

Sprite characters are displayed on the top layer of the display screen.

(1) Sprite character configuration

• **Sprite character display example**

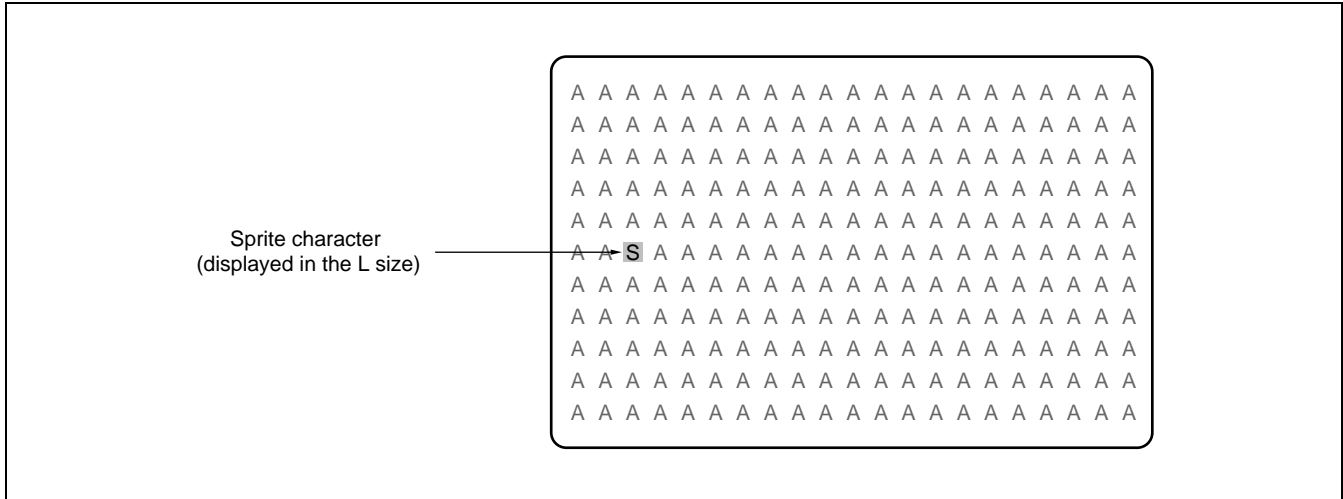

(2) Sprite character display control

• **Sprite character output control**

Screen output control 1A (Command 5-00): Bit SDS

SDS	Sprite character output
0	OFF
1	ON

• **Sprite character code**

Sprite character control 2 (Command 8-1): Bits SM7 to SM0

A sprite character code can be selected from among character codes 00_H to FF_H for 256 types of characters. When the sprite character consists of two characters, only an even-numbered character code can be set.

• **Sprite character color**

Sprite character control 1 (Command 8-0): Bits SC3 to SC0

One of 16 colors can be set.

• **Sprite character trimming color**

Sprite character control 1 (Command 8-0): Bits SF3 to SF0

One of 16 colors can be set.

- **Sprite character trimming control**

Sprite character control 1 (Command 8-0): Bits SFB and SFA

SFB	SFA	Sprite character trimming output
0	0	Undisplay
0	1	Reserved (Setting prohibited)
1	0	Reserved (Setting prohibited)
1	1	Eight-direction trimming

- **Sprite character vertical display position control**

Sprite character control 4 (Command 9-0): Bits SY9 to SY0
Settable between 0 and 1023 dots in 1-dot units.

- **Sprite character horizontal display position control**

Sprite character control 5 (Command 9-1): Bits SX9 to SX0
Settable between 0 and 1023 dots in 1-dot units.

- **Sprite character configuration control**

Sprite character control 2 (Command 8-1): Bits SD1 and SD0

SD1	SD2	Sprite character configuration
0	0	1 character
0	1	Reserved (Setting prohibited)
1	0	Stack of 2 characters
1	1	Reserved (Setting prohibited)

- **Sprite character configuration example**

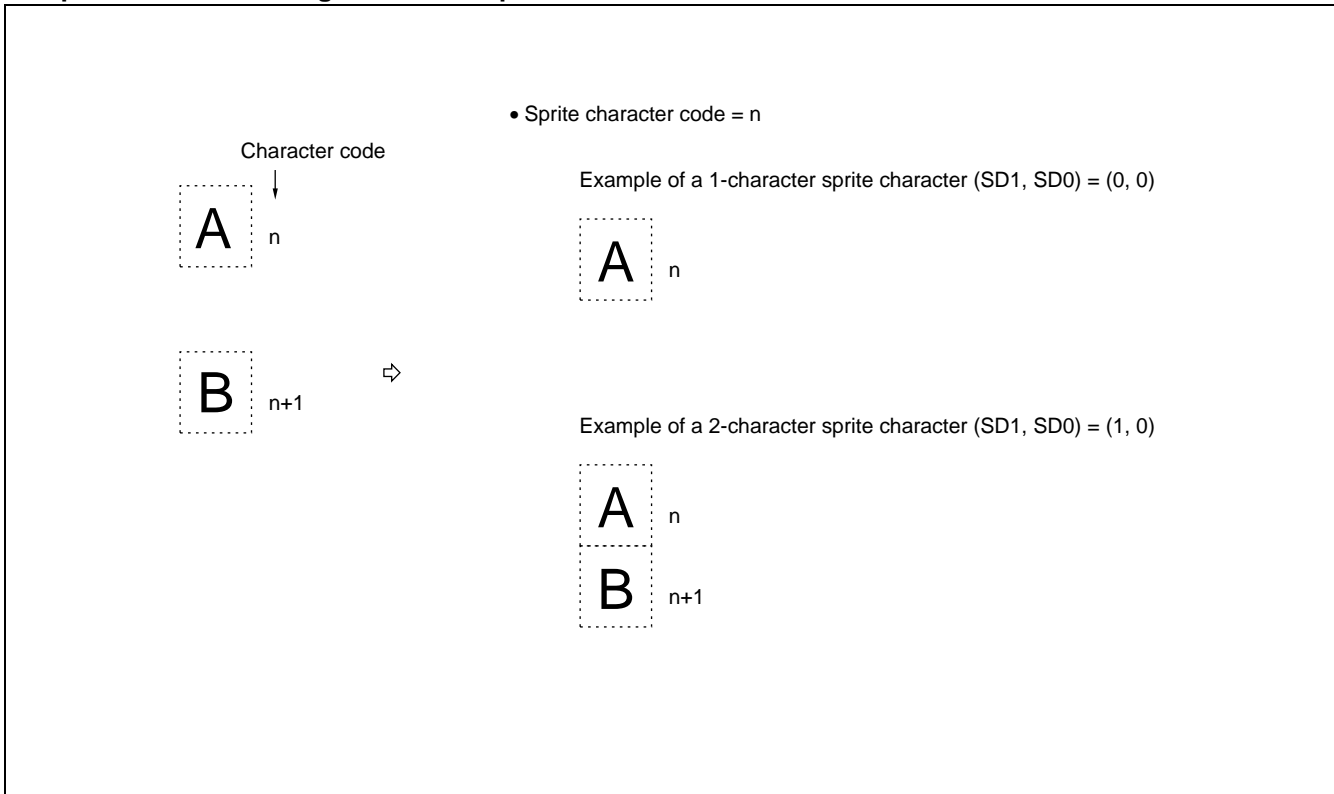

(3) Three-channel output control for sprite characters

When sprite character output is ON (SDS = 1), the sprite character outputs to output B and output C can be controlled independently. (Output A is controlled only with the SDS bit.)

- **Output-B sprite character output control**

Screen output control 1B (Command 5-01): Bit SOB

SOB	Output-B sprite character output
0	OFF ^{*1}
1	ON ^{*2}

- **Output-C sprite character output control**

Screen output control 1C (Command 5-02): Bit SOC

SOC	Output-C sprite character output
0	OFF ^{*1}
1	ON ^{*2}

*1: When the lower layer has display output, that portion appear transparent.
(The lower layer cannot be displayed.)

*2: Enabled only when screen background color output is ON (SDS = 1).

■ CONTROL FUNCTIONS

1. Serial Command Control

The MB90097 executes serial command/data transfer using the chip select (\overline{CS}), serial clock (SCLK), and serial data input (SIN) pins. The data transfer direction (MSB-first or LSB-first transfer) is selected under control of the serial data input direction select (SDR) pin. The data length is 16 bits. If the \overline{CS} pin goes High during transfer with data less than 16 bits, command transfer is not guaranteed. Keeping the \overline{CS} pin Low allows multiple items of command data to be transferred continuously. (It is however recommended to set the \overline{CS} pin to the High level at intervals of tens of words for word synchronization.)

The SCLK clock frequency is 4 MHz at maximum. Set it such that: VRAM write cycle (a minimum of 16 clock pulses) > input horizontal sync pulse width. If this condition is not satisfied, VRAM write may fail.)

(1) MSB-first signal input timing

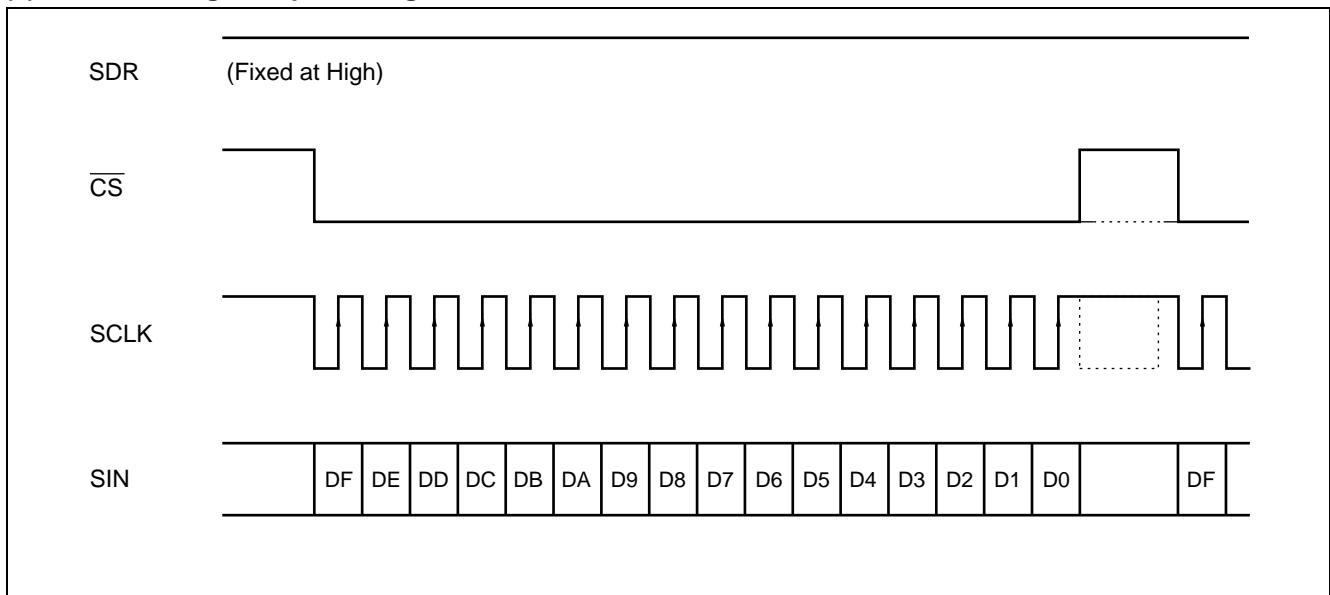

(2) LSB-first signal input timing

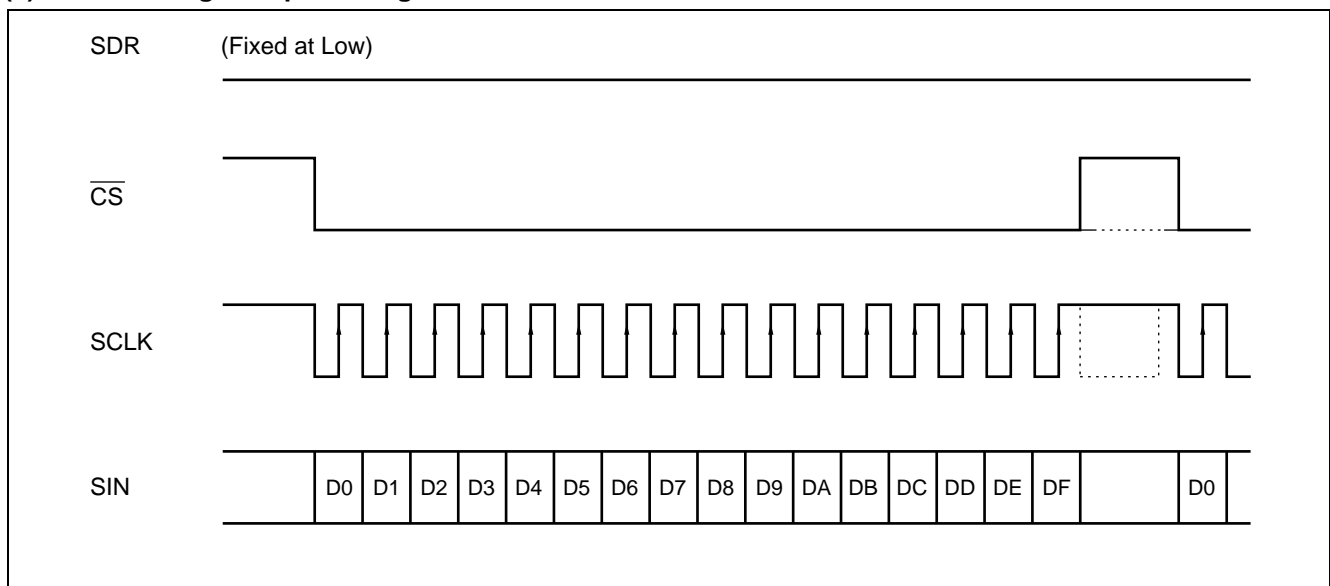

2. Dot Clock Control

For the dot clock, you can select internal generation by the LC oscillator circuit or external input.
 For the external input, you can select dot clock frequency direct input or frequency-doubled input.
 Set bits DC2 to DC0 of command 11-2 (dot clock control 1) to select dot clock control.

- **Dot clock selection control**

Dot clock control 1 (Command 11-2: Bits DC2 to DC0)

DC2	DC1	DC0	Dot clock control
0	0	0	LC oscillation
0	1	0	External input (dot clock)
0	1	1	External input (2 × dot clock)
Else			Setting prohibited

(1) Dot clock LC oscillation

Connect the relevant pins to external “L” and “C” to form an LC oscillator circuit.
 External input of a horizontal sync signal is used to internally perform oscillation stop control, enabling horizontal display synchronization.

Note: The horizontal synchronization operation edge must be the trailing edge.
 Set the horizontal synchronization operation edge (bit HE) of I/O pin control (command 13-0) to 0.)

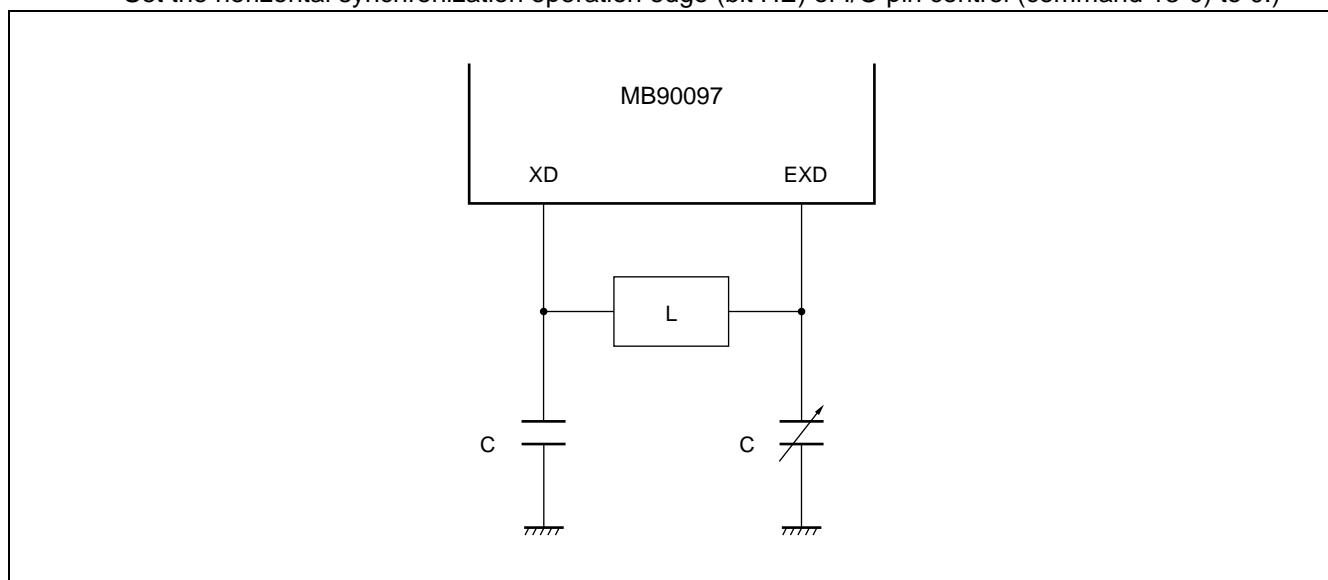

(2) External dot clock input

The MB90097 inputs a dot clock signal to the EXD pin.

Note: The input horizontal cycle must be synchronized in integer multiples of the input clock cycle.
The input clock signal must be a continuous signal without being intermitted.

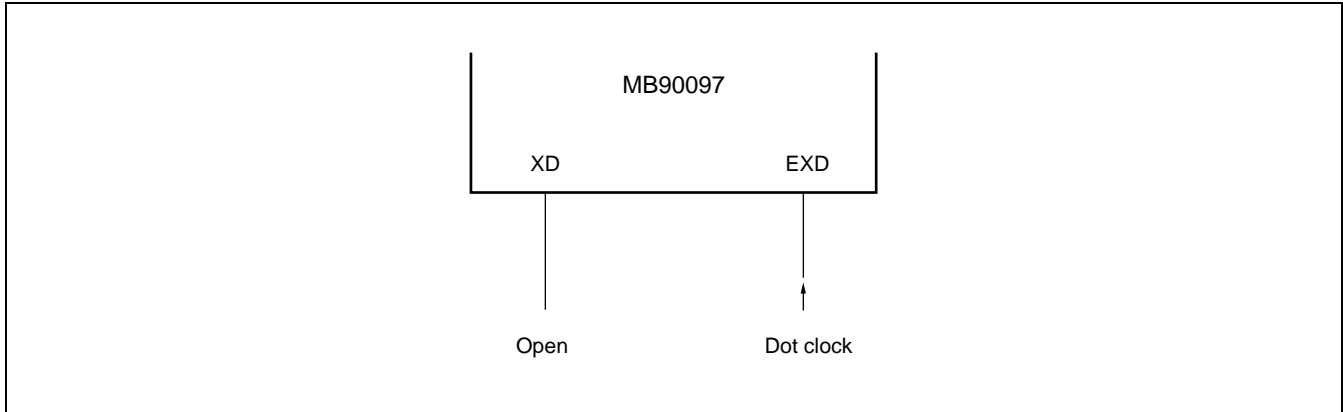

(3) External "2 ×" (frequency-doubled) dot clock input

Input the 2 × (frequency-doubled) dot clock signal to the EXD pin.

Note: The input horizontal cycle must be synchronized in integer multiples of the input clock cycle.
The horizontal synchronization operation edge must be the trailing edge.
(Set the horizontal synchronization operation edge (bit HE) of I/O pin control (command 13-0) to 0.)
The input clock signal must be a continuous signal without being intermitted.

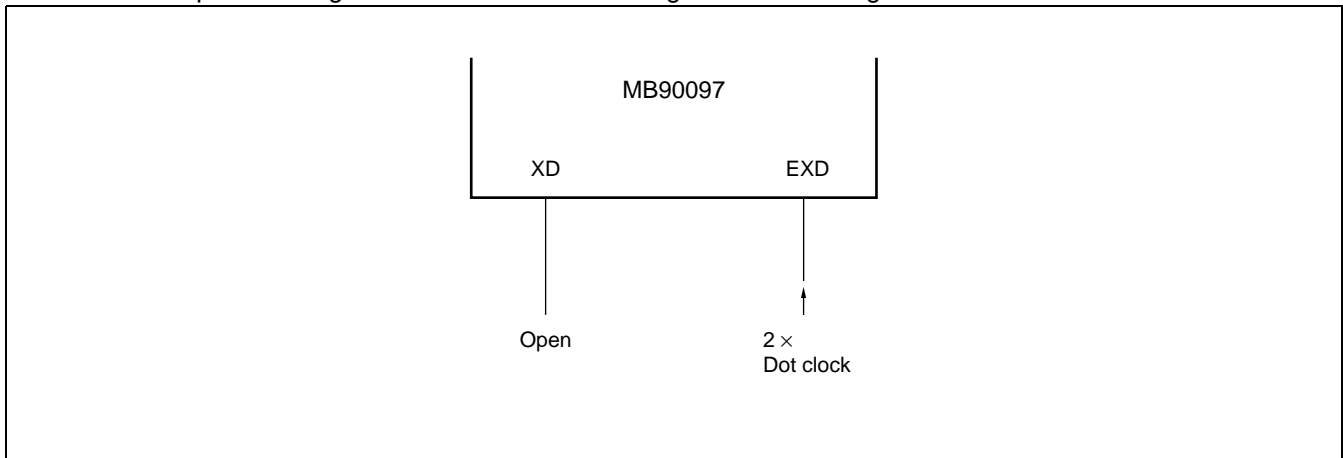

3. Sync Signal Input

3.1 Vertical Synchronization Detection

Vertical synchronization is detected by sensing the level of the vertical sync signal at the leading or trailing edge of the horizontal sync pulse to detect the transition. The vertical display position on the screen depends on the vertical synchronization detection position.

Use I/O pin control (command 13-0) to select operation control.

- **Selecting a vertical synchronization detection edge**
- **Selecting a vertical synchronization detection HSYNC edge**

VVE	Vertical synchronization detection edge
0	Detect the leading edge of VSYNC.
1	Detect the trailing edge of VSYNC.

VHE	Vertical synchronization detection HSYNC edge
0	Detect vertical synchronization at the leading edge of HSYNC.
1	Detect vertical synchronization at the trailing edge of HSYNC.

Note: When $VVE = 1$, $VHE = 1$ and $HE = 1$, the trailing edge of VSYNC is detected at the leading edge of HSYNC. "HE" is the horizontal sync operation edge selection bit.

- **Sync signal input logic control**

SIX	Sync signal input logic
0	The \overline{HSYNC} and \overline{VSYNC} pins are active low inputs.
1	The \overline{HSYNC} and \overline{VSYNC} pins are active high inputs.

- **Principle of operation of detecting vertical synchronization (Example with sync signal input logic SIX = 0)**

(1) Detecting the leading edge of the vertical sync pulse at the leading edge of the horizontal sync pulse ($VVE = 0$, $VHE = 0$)

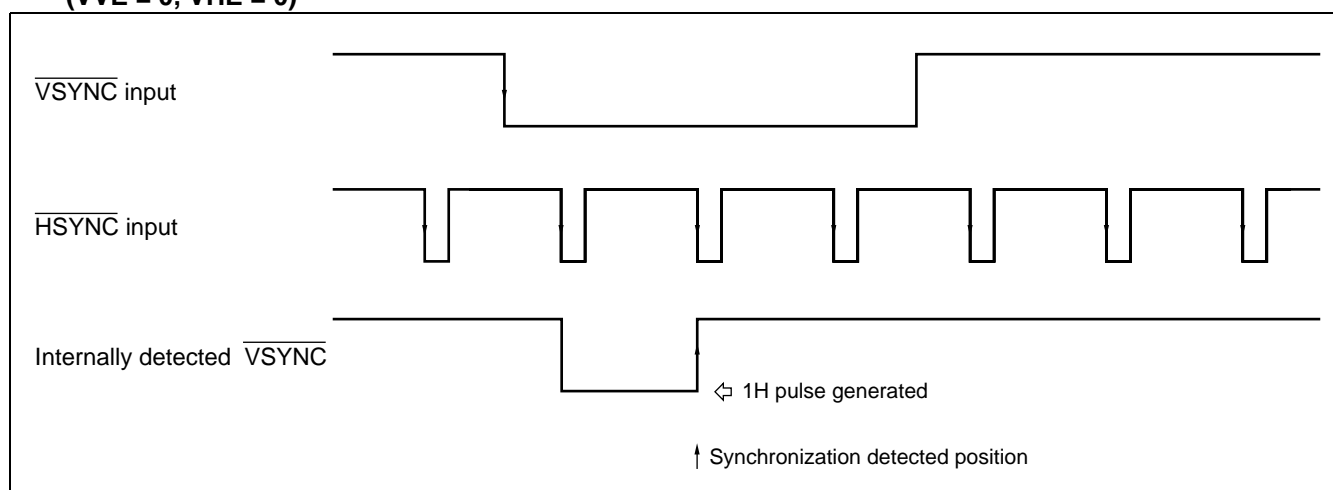

(2) Detecting the leading edge of the vertical sync pulse at the trailing edge of the horizontal sync pulse (VVE = 0, VHE = 1)

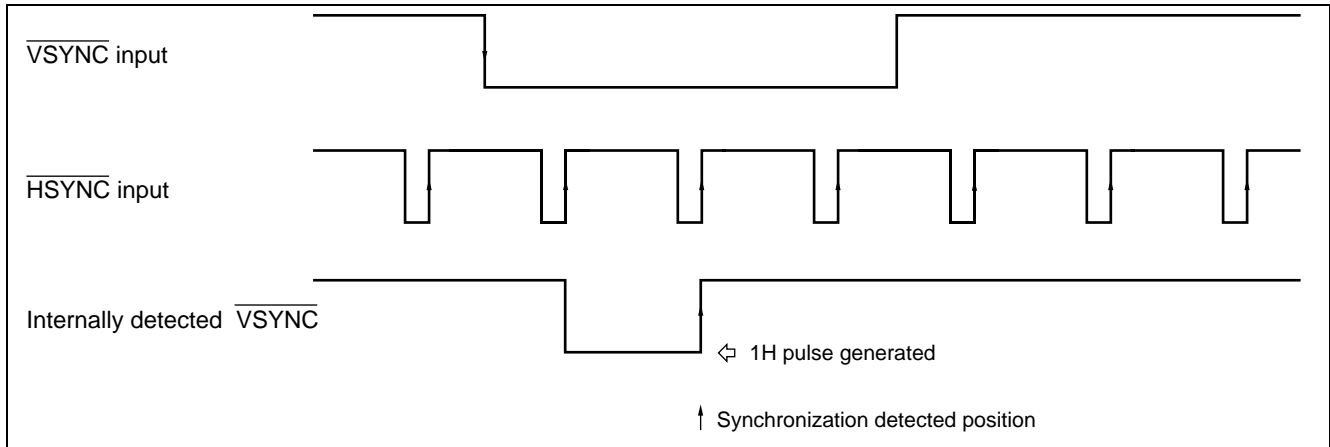

(3) Detecting the trailing edge of the vertical sync pulse at the leading edge of the horizontal sync pulse (VVE = 1, VHE = 0) or (VVE = 1, VHE = 1, HE = 1)

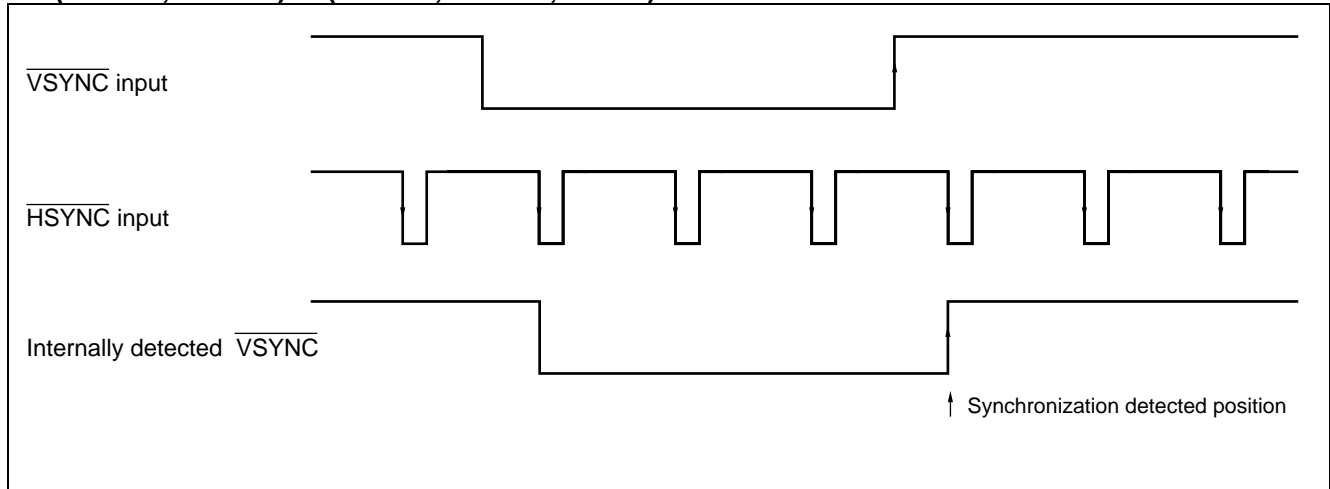

(4) Detecting the trailing edge of the vertical sync pulse at the trailing edge of the horizontal sync pulse (VVE = 1, VHE = 1, HE = 0)

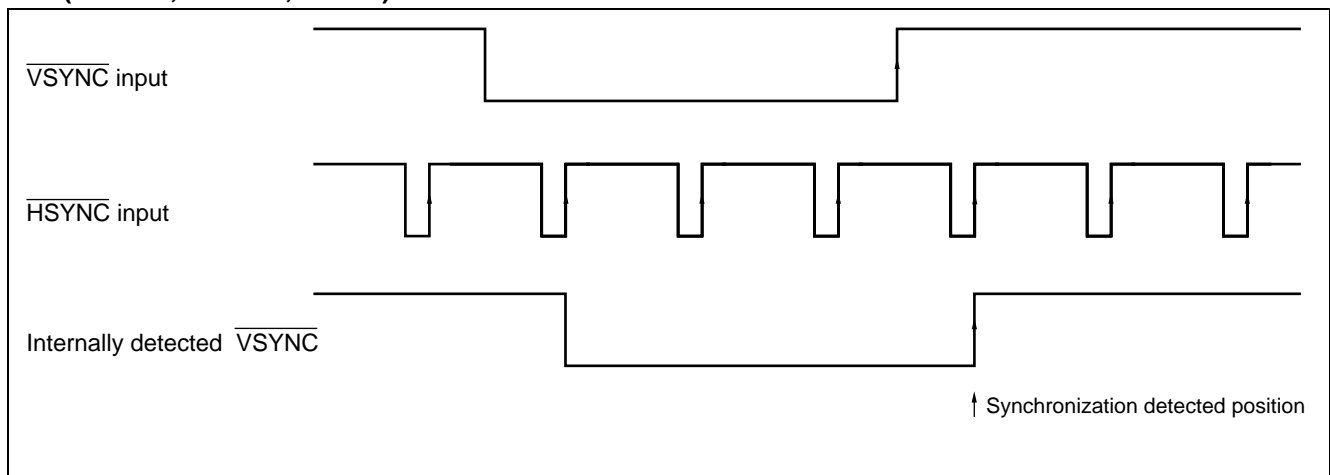

3.2 Operation in Horizontal Synchronization

(1) Operation with dot clock LC oscillation

The sync pulse of the input horizontal sync signal is used to control the oscillation and stop of the dot clock, enabling display horizontal synchronization.

Bit HE (horizontal synchronization operation edge) of I/O pin control (command 13-0) must be set to "0".

• Operation example of horizontal synchronization

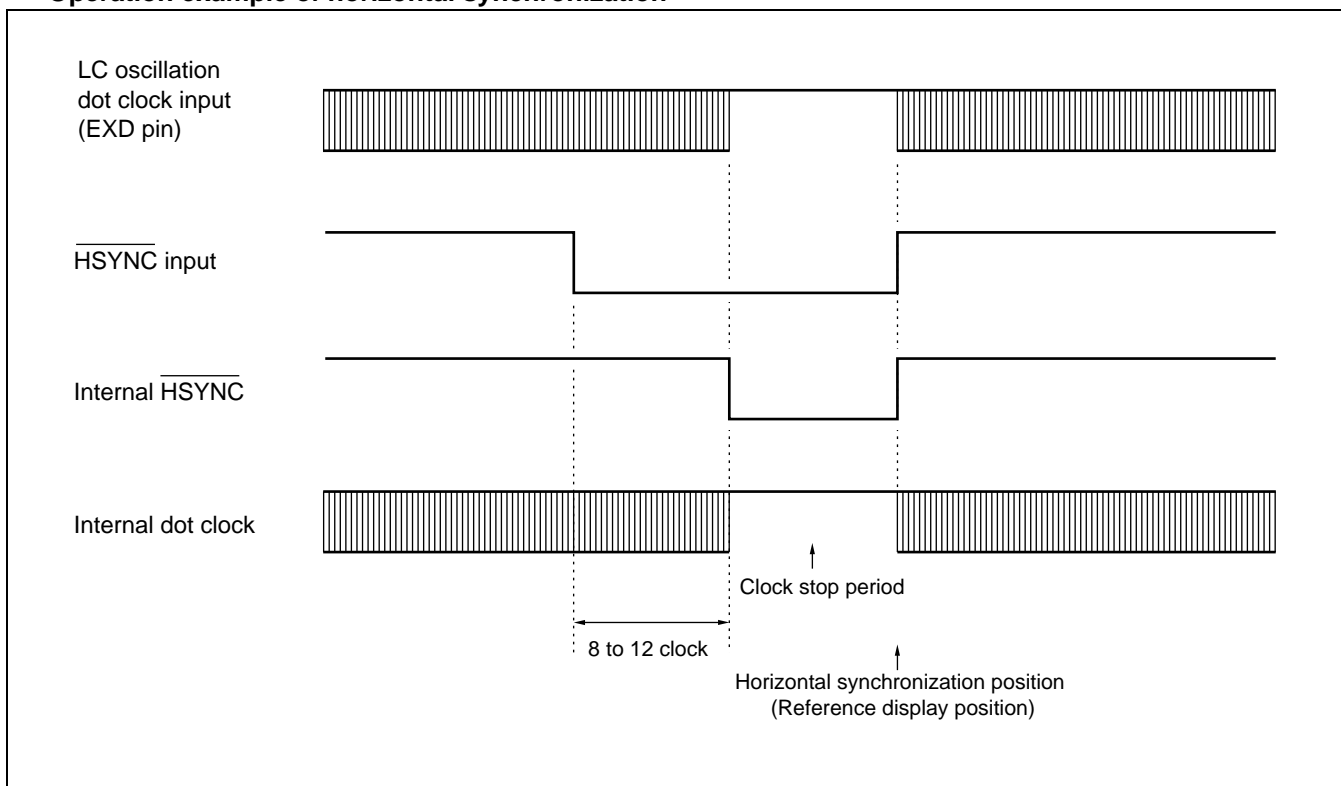

(2) Operation with external dot clock input

You can select horizontal sync leading-edge or trailing-edge operation.

• Horizontal synchronization operation edge selection

I/O pin control (Command 13-0): Bit HE

HE	Horizontal synchronization operation edge
0	Trailing-edge operation
1	Leading-edge operation

• Examples of horizontal synchronization operations

(a) Horizontal sync trailing-edge operation (HE = 0)

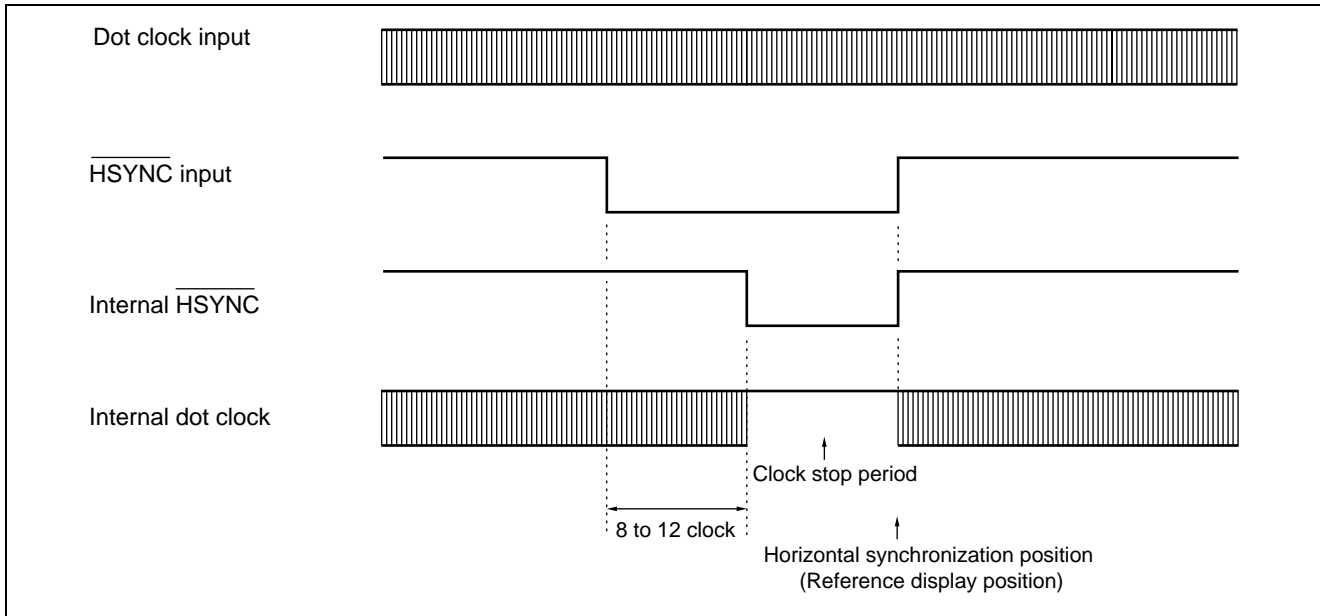

(b) Horizontal sync leading-edge operation (HE = 1)

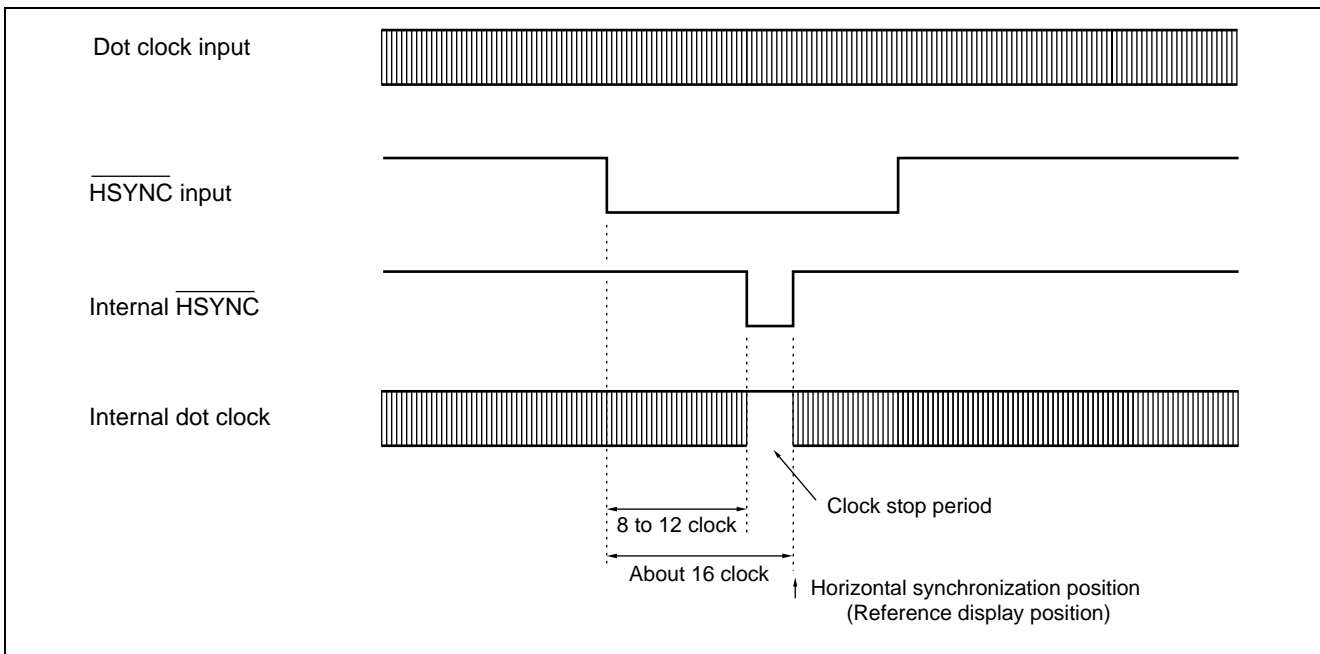

3.3 Vertical Blanking Control

Vertical blanking control is used to internally generate the vertical blanking interval for display signal output control.

Display signal output is stopped during the vertical blanking interval.

Vertical blanking control results in either of the following two operations depending on the setting of bit VVE (vertical synchronization detection edge selection control) of I/O pin control (command 13-0).

(1) Operation of vertical sync leading-edge detection

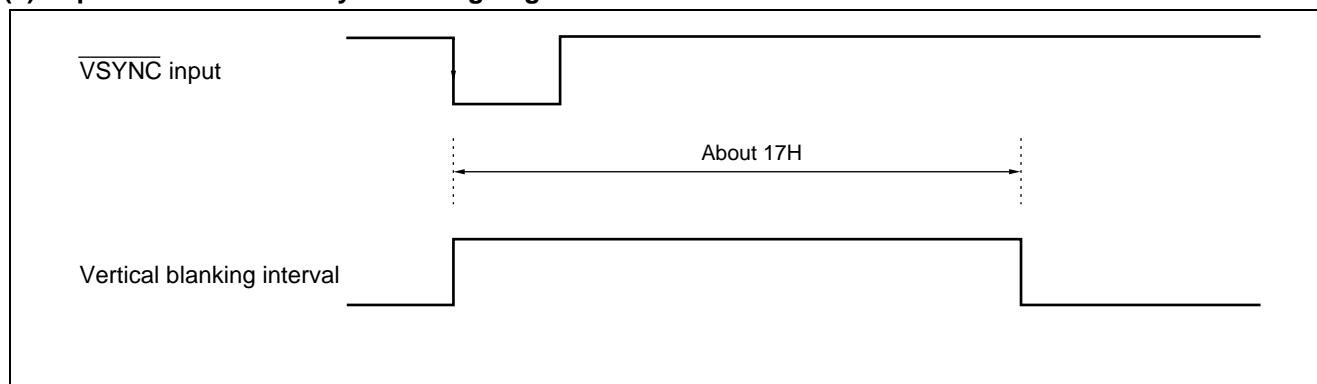

(2) Operation of vertical sync trailing-edge detection

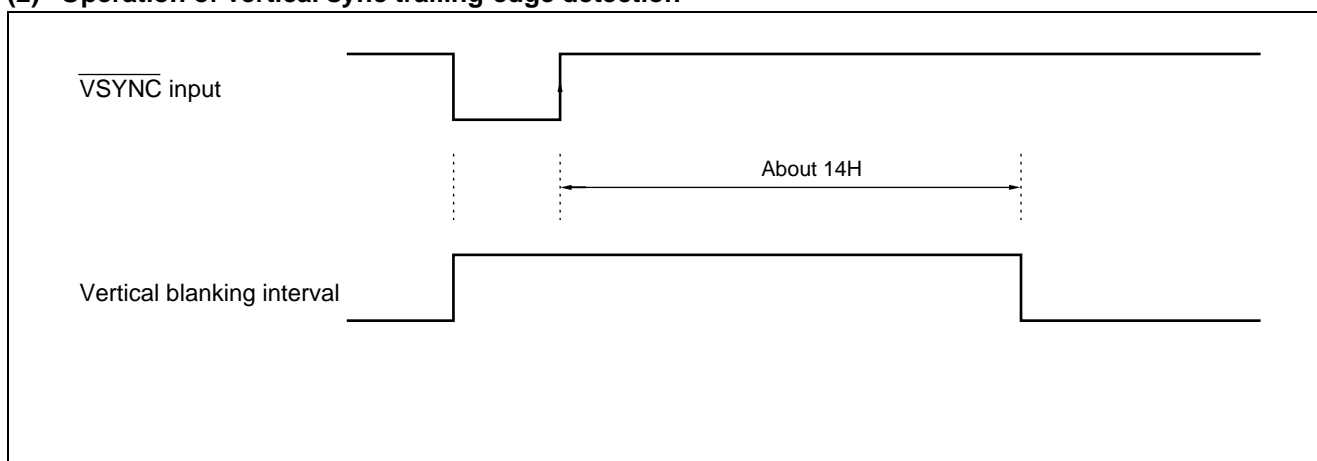

3.4 Horizontal Blanking Control

Horizontal blanking control is used to generate the horizontal blanking interval for display signal output control. Display signal output is stopped during the horizontal blanking interval.

Horizontal blanking control can be set for the back porch or front porch by command control.

Horizontal blanking control results in either of the following two operations depending on the setting of bit HE (horizontal synchronization operation edge selection control) of I/O pin control (command 13-0).

(1) When the horizontal synchronization operation edge is the trailing edge (bit HE = 0)

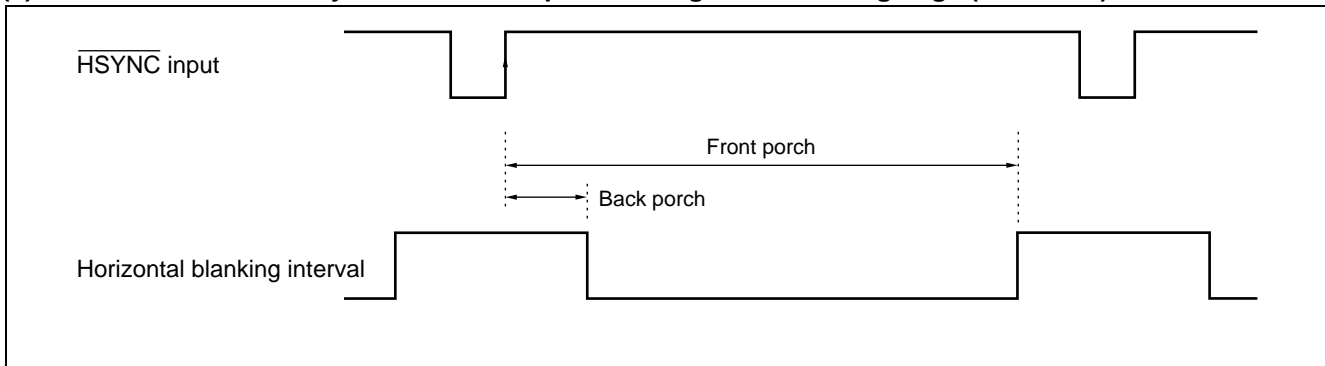

(2) When the horizontal synchronization operation edge is the leading edge (bit HE = 1)

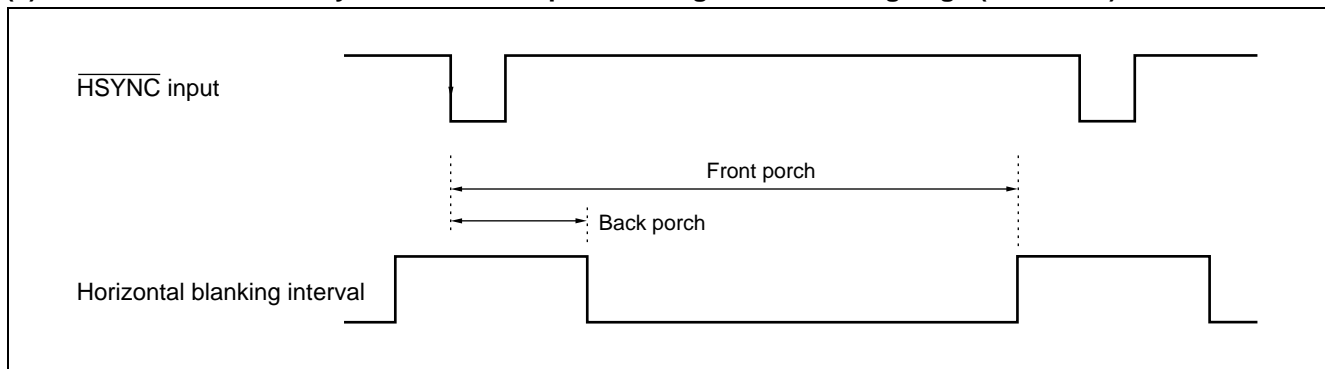

- Horizontal blanking (back porch) control
Horizontal blanking control 1 (Command 13-1): Bits BB5 to BB0
Setting between 0 and 126 dots in 2-dot units.
- Horizontal blanking (front porch) control
Horizontal blanking control 2 (Command 13-2): Bits BF8 to BF0
Setting between 0 and 1022 dots in 2-dot units.

Notes:

- The back porch must be shorter than the front porch. Do not make any other setting.
- The actual horizontal blanking interval is offset from the set value by several tens of dots in the positive direction.

4. Display Signal Output

4.1 Three-Channel Output Control

(1) Display control bits and control ranges

The following chart summarizes the relationships among display control and three-channel output control bits.

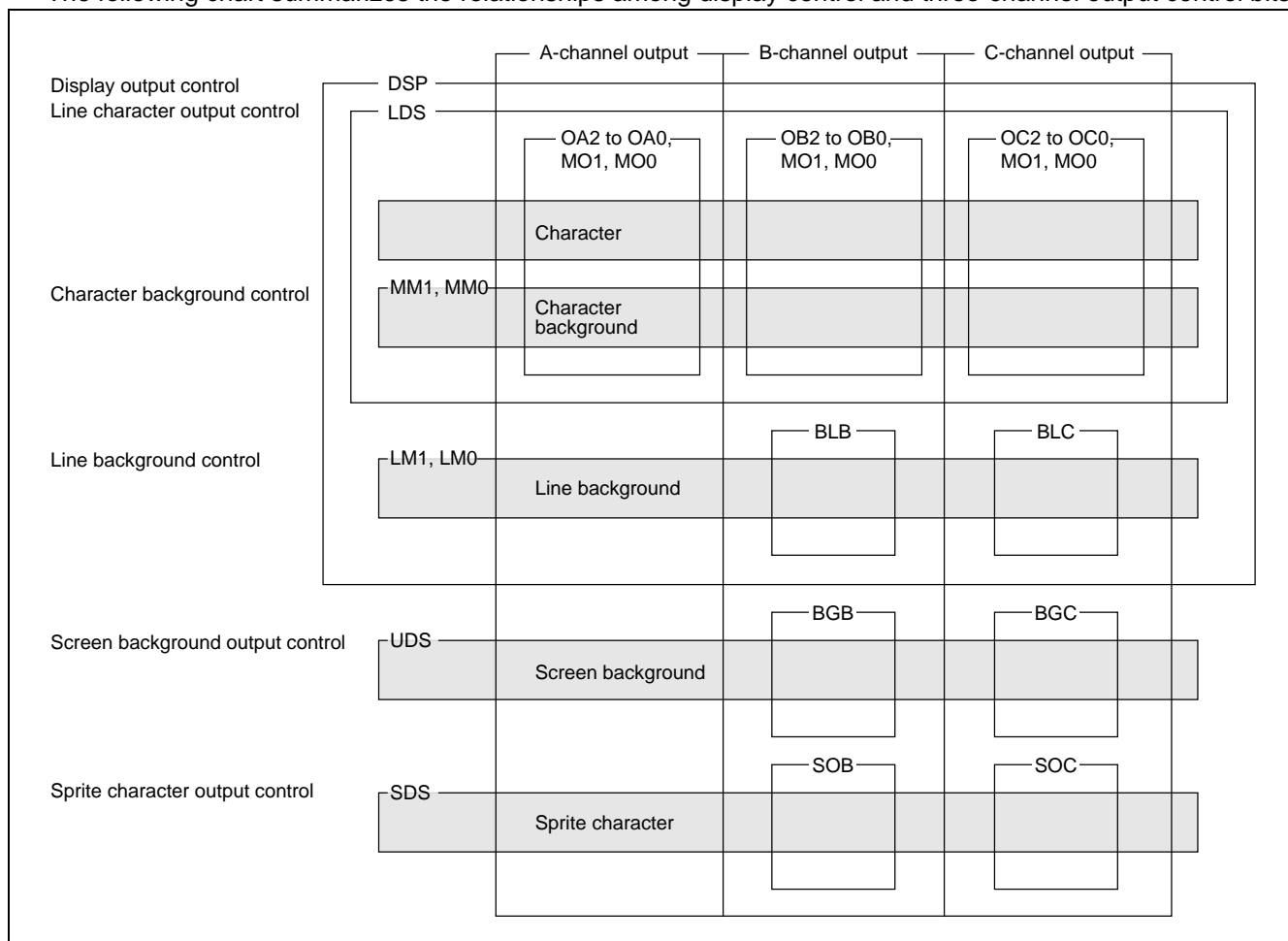

- If character display of a character is turned OFF by bits OA2-OA0, OB2-OB0, OC2-OC0, or MO1, MO0, the character (including its trimming and character background) is displayed transparent, including the corresponding portion of the lower layer (line and screen backgrounds).
- If line background display is turned OFF by bit BLB, the line background and the corresponding portion of the screen background display layer are displayed transparent.
- If line background display is turned OFF by bit BLC, the line background and the corresponding portion of the screen background display layer are displayed transparent.
- If screen background display is turned OFF by bit BGB, the screen background display layer is displayed transparent.
- If screen background display is turned OFF by bit BGC, the screen background display layer is displayed transparent.
- If sprite character display is turned OFF by bit SCB, the sprite character (including its trimming) and the corresponding portions of all lower layers are displayed transparent.
- If sprite character display is turned OFF by bit SCC, the sprite character (including its trimming) and the corresponding portions of all lower layers are displayed transparent.

(2) Output-A/B/C control

The character attributes (character, trimming, and character background) of each character can be displayed by three-channel (A/B/C) output control.

Commands 5-00 to 5-02 are used for output control for each screen; command 2 is used for output control for each character.

When trimming dots for a character are displayed protruding to the area for an adjacent character, the output of the trimming dots is controlled by the character output control of that adjacent character. Three-channel output control for each character serves as output control within the character area (12 × 18 dots for normal-sized characters).

If there are trimming dots to the left of the leftmost character on a line, they cannot be controlled by three-channel output control. In this case, place a blank character at the left end of the line and set characters to be displayed to the right.

When trimming dots are displayed to the right of the rightmost character on a line, the three-channel output control of the trimming dots depends on the character output control of the rightmost character.

- **Output-A character control**

Screen output control 1A (Command 5-00): Bits OA2 to OA0

Settable, selected from among eight types.

- **Output-B character control**

Screen output control 1B (Command 5-01): Bits OB2 to OB0

Settable, selected from among eight types.

- **Output-C character control**

Screen output control 1C (Command 5-02): Bits OC2 to OC0

Settable, selected from among eight types.

- **Character output control**

Character data setting 2 (Command 2): Bits MO1 and MO0

Settable, selected from among four types for each character.

Output-A/B/C character control			Character output control		Output (Pin output)	
OA2 / OB2 / OC2	OA1 / OB1 / OC1	OA0 / OB0 / OC0	MO1	MO0	Output-A (BLKA pin output) / Output-B (BLKB pin output) / Output-C (BLKC pin output)	
0	0	0	0	0	×	All display OFF
			0	1	×	
			1	0	×	
			1	1	×	
0	0	1	0	0	○	All display ON
			0	1	○	
			1	0	○	
			1	1	○	

○ : Display ON

× : Display OFF

(Continued)

(Continued)

Output-A/B/C character control			Character output control		Output (Pin output)	
OA2 / OB2 / OC2	OA1 / OB1 / OC1	OA0 / OB0 / OC0	MO1	MO0	Output-A (BLKA pin output) / Output-B (BLKB pin output) / Output-C (BLKC pin output)	
0	1	0	0	0	×	Display ON for only characters with MO0 = 1
			0	1	○	
			1	0	×	
			1	1	○	
0	1	1	0	0	×	Display ON for only characters with MO1 = 1
			0	1	×	
			1	0	○	
			1	1	○	
1	0	0	0	0	×	Display ON for only characters with MO0 = 1 or MO1 = 1
			0	1	○	
			1	0	○	
			1	1	○	
1	0	1	0	0	○	Display ON for only characters with MO0 = 0
			0	1	×	
			1	0	○	
			1	1	×	
1	1	0	0	0	○	Display ON for only characters with MO1 = 0
			0	1	○	
			1	0	×	
			1	1	×	
1	1	1	0	0	○	Display ON for only characters with MO0 = 0 or MO1 = 0
			0	1	×	
			1	0	×	
			1	1	×	

○ : Display ON

× : Display OFF

4.2 Display Signal Output Timings

Display signals are output as shown below.

- Output channel-A display period signal: BLKA pin
- Output channel-B display period signal: BLKB pin
- Output channel-C display period signal: BLKC pin
- Color code signals: VC3 to VC0 pin
- **Display signal output example**

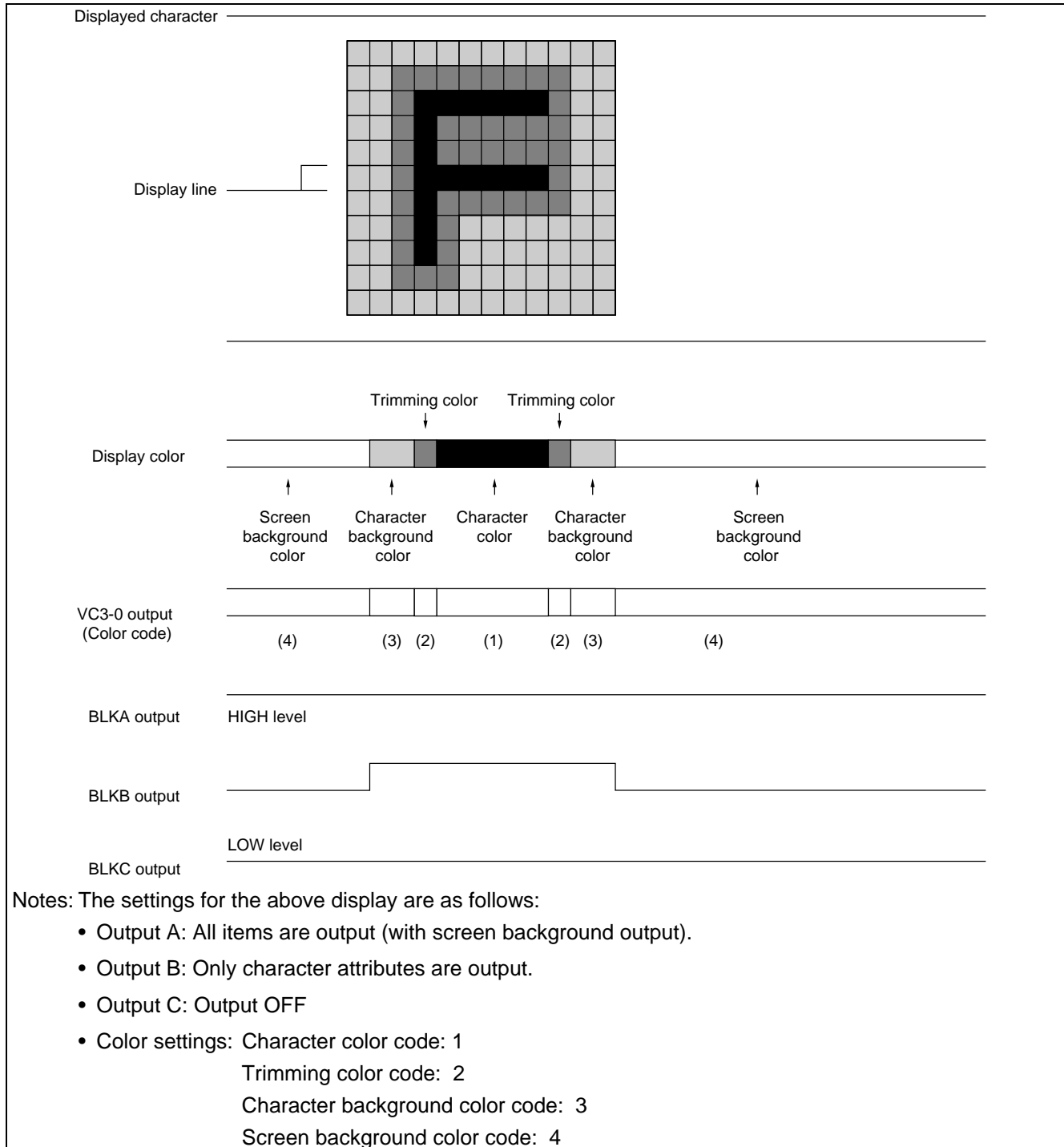

■ CONTENTS OF MB90097-001 (STANDARD PRODUCT) FONT ROM

0	1	2	3	4	5	6	7	8	9	:	;	?	!	.	
000	001	002	003	004	005	006	007	008	009	00A	00B	00C	00D	00E	00F
A	B	C	D	E	F	G	H	I	J	K	L	M	N	O	P
010	011	012	013	014	015	016	017	018	019	01A	01B	01C	01D	01E	01F
Q	R	S	T	U	V	W	X	Y	Z	()	()	()
020	021	022	023	024	025	026	027	028	029	02A	02B	02C	02D	02E	02F
a	b	c	d	e	f	g	h	i	j	k	l	m	n	o	p
030	031	032	033	034	035	036	037	038	039	03A	03B	03C	03D	03E	03F
q	r	s	t	u	v	w	x	y	z	+	-	*	/	=	¥
040	041	042	043	044	045	046	047	048	049	04A	04B	04C	04D	04E	04F
0	1	2	3	4	5	6	7	8	9	"	'	#	\$	%	&
050	051	052	053	054	055	056	057	058	059	05A	05B	05C	05D	05E	05F
A	B	C	D	E	F	G	H	I	J	K	L	M	N	O	P
060	061	062	063	064	065	066	067	068	069	06A	06B	06C	06D	06E	06F
Q	R	S	T	U	V	W	X	Y	Z	f	i	j	l	t	~
070	071	072	073	074	075	076	077	078	079	07A	07B	07C	07D	07E	07F
0	1	2	3	4	5	6	7	8	9	:	;	?	!	.	
080	081	082	083	084	085	086	087	088	089	08A	08B	08C	08D	08E	08F
A	B	C	D	E	F	G	H	I	J	K	L	M	N	O	P
090	091	092	093	094	095	096	097	098	099	09A	09B	09C	09D	09E	09F
Q	R	S	T	U	V	W	X	Y	Z	ff	fi	fl	ft	~	
0A0	0A1	0A2	0A3	0A4	0A5	0A6	0A7	0A8	0A9	0AA	0AB	0AC	0AD	0AE	0AF
Q	U	e	â	ä	à	â	ç	ê	ë	è	ÿ	î	ï	Ä	Å
0B0	0B1	0B2	0B3	0B4	0B5	0B6	0B7	0B8	0B9	0BA	0BB	0BC	0BD	0BE	0BF
É	æ	È	ó	ô	ò	ó	ú	ÿ	ö	ü	ç	É	É	É	É
0C0	0C1	0C2	0C3	0C4	0C5	0C6	0C7	0C8	0C9	0CA	0CB	0CC	0CD	0CE	0CF
ä	í	ó	ú	ñ	ñ	ñ	ñ	ñ	ñ	ñ	ñ	ñ	ñ	ñ	ñ
0D0	0D1	0D2	0D3	0D4	0D5	0D6	0D7	0D8	0D9	0DA	0DB	0DC	0DD	0DE	0DF
H															
0E0	0E1	0E2	0E3	0E4	0E5	0E6	0E7	0E8	0E9	0EA	0EB	0EC	0ED	0EE	0EF
▼	▲	▼	▲	●	□	□	□	◀	▶	○	●	▲	▼	■	
0F0	0F1	0F2	0F3	0F4	0F5	0F6	0F7	0F8	0F9	0FA	0FB	0FC	0FD	0FE	0FF

(Continued)

(Continued)

あ	い	う	え	お	か	き	く	け	こ	さ	し	す	せ	そ	た
100	101	102	103	104	105	106	107	108	109	10A	10B	10C	10D	10E	10F
ち	つ	て	と	な	に	ぬ	ね	の	は	ひ	ふ	へ	ほ	ま	み
110	111	112	113	114	115	116	117	118	119	11A	11B	11C	11D	11E	11F
も	め	も	や	ゆ	よ	ら	り	る	れ	ろ	ね	を	ん	。	”
120	121	122	123	124	125	126	127	128	129	12A	12B	12C	12D	12E	12F
ア	イ	ウ	エ	オ	カ	キ	ク	ケ	コ	サ	シ	ス	セ	ソ	タ
130	131	132	133	134	135	136	137	138	139	13A	13B	13C	13D	13E	13F
チ	ツ	テ	ト	ナ	ニ	ヌ	ネ	ノ	ハ	ヒ	フ	ヘ	ホ	マ	ミ
140	141	142	143	144	145	146	147	148	149	14A	14B	14C	14D	14E	14F
ム	メ	モ	ヤ	ユ	ヨ	ラ	リ	ル	レ	ロ	ネ	ヲ	ン	。	”
150	151	152	153	154	155	156	157	158	159	15A	15B	15C	15D	15E	15F
あ	い	う	え	お	か	き	く	け	こ	さ	し	す	せ	そ	た
160	161	162	163	164	165	166	167	168	169	16A	16B	16C	16D	16E	16F
張	張	機	能	入	入	入	入	入	入	入	入	入	入	入	入
170	171	172	173	174	175	176	177	178	179	17A	17B	17C	17D	17E	17F
日	日	火	木	木	金	土	年	曜	時	分	秒	録	画	用	生
180	181	182	183	184	185	186	187	188	189	18A	18B	18C	18D	18E	18F
早	送	巻	戻	停	止	毎	週	予	約	間	始	終	了	設	定
190	191	192	193	194	195	196	197	198	199	19A	19B	19C	19D	19E	19F
標	準	倍	人	力	冒	声	主	副	左	右	奥	行	確	認	自
1A0	1A1	1A2	1A3	1A4	1A5	1A6	1A7	1A8	1A9	1AA	1AB	1AC	1AD	1AE	1AF
動	選	報	運	会	報	学	卒	業	武	装	倉	土	産	文	字
1B0	1B1	1B2	1B3	1B4	1B5	1B6	1B7	1B8	1B9	1BA	1BB	1BC	1BD	1BE	1BF
行	面	背	景	凹	凹	平	垂	直	表	示	社	置	間	隔	色
1C0	1C1	1C2	1C3	1C4	1C5	1C6	1C7	1C8	1C9	1CA	1CB	1CC	1CD	1CE	1CF
縮	横	単	影	付	種	系	統	出	制	御	格	信	号	補	刻
1D0	1D1	1D2	1D3	1D4	1D5	1D6	1D7	1D8	1D9	1DA	1DB	1DC	1DD	1DE	1DF
午	前	後	甲	申	大	前	前	前	前	前	前	前	前	前	前
1E0	1E1	1E2	1E3	1E4	1E5	1E6	1E7	1E8	1E9	1EA	1EB	1EC	1ED	1EE	1EF
前	前	前	前	前	前	前	前	前	前	前	前	前	前	前	前
1F0	1F1	1F2	1F3	1F4	1F5	1F6	1F7	1F8	1F9	1FA	1FB	1FC	1FD	1FE	1FF

■ ORDERING INFORMATION

Part number	Package	Remarks
MB90097-PFV	20-pin plastic SSOP (FPT-20P-M03)	

MB90097

■ PACKAGE DIMENSION

20-pin plastic SSOP
(FPT-20P-M03)

* : These dimensions do not include resin protrusion.

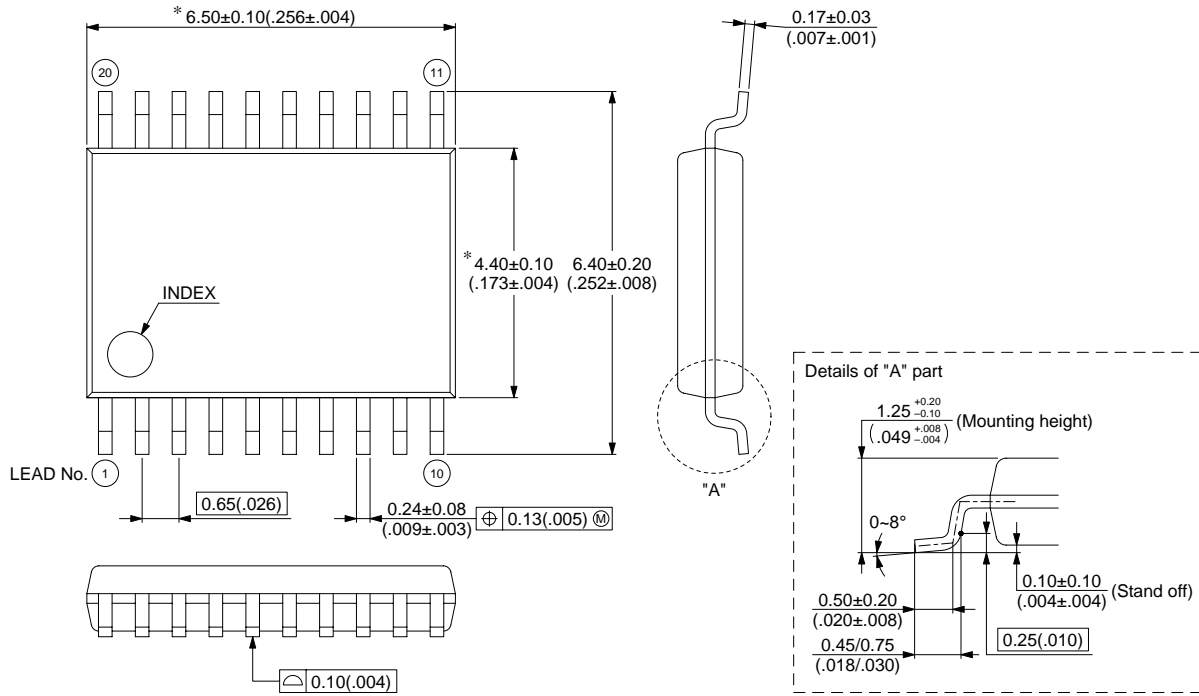

© 1999 FUJITSU LIMITED F20012S-3C-5

Dimensions in mm (inches).

FUJITSU LIMITED

For further information please contact:

Japan

FUJITSU LIMITED
Marketing Division
Electronic Devices
Shinjuku Dai-Ichi Seimei Bldg. 7-1,
Nishishinjuku 2-chome, Shinjuku-ku,
Tokyo 163-0721, Japan
Tel: +81-3-5322-3353
Fax: +81-3-5322-3386

<http://edevic.fujitsu.com/>

North and South America

FUJITSU MICROELECTRONICS, INC.
3545 North First Street,
San Jose, CA 95134-1804, U.S.A.
Tel: +1-408-922-9000
Fax: +1-408-922-9179

Customer Response Center
Mon. - Fri.: 7 am - 5 pm (PST)
Tel: +1-800-866-8608
Fax: +1-408-922-9179

<http://www.fujitsumicro.com/>

Europe

FUJITSU MICROELECTRONICS EUROPE GmbH
Am Siebenstein 6-10,
D-63303 Dreieich-Buchsschlag,
Germany
Tel: +49-6103-690-0
Fax: +49-6103-690-122

<http://www.fujitsu-fme.com/>

Asia Pacific

FUJITSU MICROELECTRONICS ASIA PTE. LTD.
#05-08, 151 Lorong Chuan,
New Tech Park,
Singapore 556741
Tel: +65-281-0770
Fax: +65-281-0220

<http://www.fmal.fujitsu.com/>

Korea

FUJITSU MICROELECTRONICS KOREA LTD.
1702 KOSMO TOWER, 1002 Daechi-Dong,
Kangnam-Gu, Seoul 135-280
Korea
Tel: +82-2-3484-7100
Fax: +82-2-3484-7111

F0106

© FUJITSU LIMITED Printed in Japan

All Rights Reserved.

The contents of this document are subject to change without notice. Customers are advised to consult with FUJITSU sales representatives before ordering.

The information and circuit diagrams in this document are presented as examples of semiconductor device applications, and are not intended to be incorporated in devices for actual use. Also, FUJITSU is unable to assume responsibility for infringement of any patent rights or other rights of third parties arising from the use of this information or circuit diagrams.

The products described in this document are designed, and manufactured as contemplated for general use, including without limitation, ordinary industrial use, general office use, personal use, and household use, but are not designed, developed and manufactured as contemplated (1) for use accompanying fatal risks or dangers that, unless extremely high safety is secured, could have a serious effect to the public, and could lead directly to death, personal injury, severe physical damage or other loss (i.e., nuclear reaction control in nuclear facility, aircraft flight control, air traffic control, mass transport control, medical life support system, missile launch control in weapon system), or (2) for use requiring extremely high reliability (i.e., submersible repeater and artificial satellite).

Please note that Fujitsu will not be liable against you and/or any third party for any claims or damages arising in connection with above-mentioned uses of the products.

Any semiconductor devices have inherently a certain rate of failure. You must protect against injury, damage or loss from such failures by incorporating safety design measures into your facility and equipment such as redundancy, fire protection, and prevention of over-current levels and other abnormal operating conditions.

If any products described in this document represent goods or technologies subject to certain restrictions on export under the Foreign Exchange and Foreign Trade Control Law of Japan, the prior authorization by Japanese government should be required for export of those products from Japan.