

Resonator

Piezoelectric Resonator

FAR Family (C1, C3, C4 series)

■ DESCRIPTION

Fujitsu resonators (C1, C3, C4 series) feature originally developed single crystals with a high electromechanical coupling coefficient (LiTaO₃: lithium tantalate, LiNbO₃: lithium niobate), the result is compact packaging. Three series are available: the C3 and C4 series with built-in capacitors for high integration, for exclusive use in microcomputer clocks; and the C1 series for high precision. All series include the CHIP type device for surface-mount and the SIP type device for general PC boards.

■ FEATURES

- Surface-mount technology can be applied to the CHIP type to increase packaging density. The SIP type is only half the height of conventional quartz crystal resonators, and can be easily mounted on general PC boards.
- The C3 and C4 series have been developed for exclusive use in microcomputer clocks. They have built-in capacitors, and the number of components has been reduced to one-third of that of conventional circuits.
- Both the SIP and CHIP types can be shipped in taped packages for automatic mounting.
- The resonators have superior shock and vibration resistance, preventing damage during automatic insertion process.

■ PACKAGE

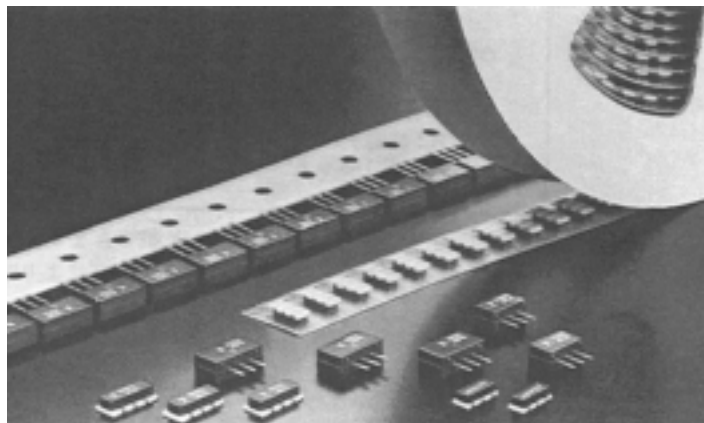

FAR Family (C1, C3, C4 series)

STANDARD CHARACTERISTICS

Series	C1 series	C3 series	C4 series
Material	Lithium Tantalate (LiTaO ₃)		Lithium Niobate (LiNbO ₃)
Frequency	3.58 to 16 MHz		3 to 16 MHz
Standard frequency	See "Standard frequency."		
Initial frequency tolerance	±0.05% (G) ±0.1% (J) ±0.3% (K) ±0.5% (M)	±0.1% (J) ±0.3% (K) ±0.5% (M)	±0.5% (M) ±0.3% (K) ±1% (L)
Temperature characteristics (-20 to 60°C)	±0.02%	±0.05%	±0.5%
Capacity of built-in capacitor	—	20±8 pF (standard)*	
Aging stability	Within ±0.1%		
Operating temperature	-30 to 85°C		
Storage temperature	-40 to 100°C		
Standard measuring circuit	<p>(Resonant frequency and serial resonant resistance)</p>	<p>(Oscillation frequency)</p> <p>3 MHz to 10 MHz max. IC; 1/6MB84069B x 2 10 MHz to 16 MHz IC; MC74HC04 V_{cc}; 5 VDC R; Resonator C1, C2: Loading capacitors (built-in)</p>	<p>(Serial resonant resistance)</p>

*: The capacity of the built-in capacitor is 20±8 pF by standard. 10±4 pF and 30±8 pF types are also available. However, the characteristics of 10±4 pF and 30±8 pF types are specified by Fujitsu, considering matching data with applied IC (mainly microcomputer).

FAR Family (C1, C3, C4 series)

■ STANDARD FREQUENCY

Standard frequency (kHz)	C1/C3 series		C4 series	
	Package size	Resonant resistance	Package size	Resonant resistance
3,580 4,000 4,194 4,915	A A A A	300 Ω max. (00)	A A A A	150 Ω max. (01)
6,000 6,144 7,373 8,000 10,000 11,000 11,059 12,000 14,746 16,000	B B B B B B B B B B	150 Ω max. (01)	B B B B B B B B B B	75 Ω max. (02)

• Package sizes and resonant resistance

There are two package sizes according to frequency:

Frequency	Package size
3 to 5.99 MHz	A
6 to 16 MHz	B

For resonant resistance, standard values are specified according to frequency:

Frequency	Standard resonant resistance	
	C1/C3 series	C4 series
3 to 3.57 MHz	—	300 Ω max. (00)
3.58 to 5.99 MHz	300 Ω max. (00)	150 Ω max. (01)
6 to 16 MHz	150 Ω max. (01)	75 Ω max. (02)

Note: For resonant resistance other than the standard values, they are specified by Fujitsu considering matching data with applied IC (mainly micro computer).

■ NOTES ON USE

- Handle carefully.
- Solder under the following conditions.
CHIP type: 5 seconds max. at 230°C (PCB)
SIP type: 10 seconds max. at 260°C
Do not apply extreme heat to the resonator. Recommended preheating for the CHIP type is 150°C for one minute.
- Avoid extreme fluctuations in temperature during use.
- There is no specific direction in resonator mounting.
- Additional information is available separately, if required, for designing microcomputer oscillation circuits.
- CHIP type is for reflow solder, not for flow solder.

FAR Family (C1, C3, C4 series)

■ PART NUMBERING SYSTEM

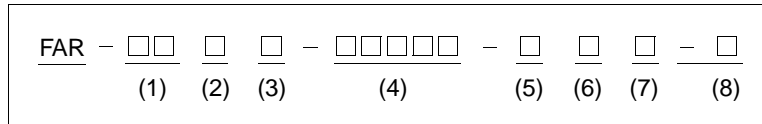

(1) Series

Series	Single crystal	Capacitor
C1	LiTaO ₃	—
C3	LiTaO ₃	With built-in capacitors
C4	LiNbO ₃	With built-in capacitors

(2) Package type

Specification	Type
C	CHIP
S	SIP

(3) Package size See Table 1 in “■ Dimensions.”

Specification	Size
A	Large
B	Small

(4) Frequency (kHz)

Frequency	Designation	Frequency	Designation	Frequency	Designation	Frequency	Designation
3,580 kHz	03580	6,000 kHz	06000	10,000 kHz	10000	14,746 kHz	14746
4,000 kHz	04000	6,144 kHz	06144	11,000 kHz	11000	16,000 kHz	16000
4,194 kHz	04194	7,373 kHz	07373	11,059 kHz	11059		
4,195 kHz	04915	8,000 kHz	08000	12,000 kHz	12000		

(5) Initial tolerance of frequency See “■ Standard Frequency.”

Specification	Tolerance	C1 series	C3 series	C4 series
G	±0.05%	available	—	—
J	±0.1%	available	available	—
K	±0.3%	available	available	available
M	±0.5%	available	available	available
L	±1%	—	—	available

FAR Family (C1, C3, C4 series)

(6) Capacity of built-in capacitor

Specification	Capacitance
0	20±8 pF
1	10±4 pF
2	30±8 pF

Note: For C1 series, only "0" is available.

(7) Resonant resistance

Specification	Resonant resistance
0	300 Ω max.
1	150 Ω max.
2	75 Ω max.

(8) User-specific Special Symbols

Specification	Description
Name	No specification, no taping specification
—	No specification, with taping specification
A to Z	Serial number for custom design

(9) Taping specification

- SIP type

Specification	Description
-T	Reel pack
-U	Ammo pack

- CHIP type

Specification	Description
-R	16 mm carrier pack

FAR Family (C1, C3, C4 series)

MARKING

(SIP type)

(CHIP type)

The stamp color varies with the capacity of the capacitor.

Capacitance	Marking color
10 pF	Yellow
20 pF	White
30 pF	Gray

Data code (EIAJ standard) is specified as follows in a four-year cycle.

Year	Month	Symbol	Year	Month	Symbol	Year	Month	Symbol	Year	Month	Symbol
1977 1981 1985 1989 1993	1	A	1978 1982 1986 1990 1994	1	N	1979 1983 1987 1991 1995	1	a	1980 1984 1988 1992 1996	1	n
	2	B		2	P		2	b		2	<i>p</i>
	3	C		3	Q		3	\bar{c}		3	<i>q</i>
	4	D		4	R		4	d		4	r
	5	E		5	E		5	e		5	<i>s</i>
	6	F		6	T		6	f		6	t
	7	G		7	U		7	\bar{f}		7	u
	8	H		8	V		8	<i>h</i>		8	<i>u</i>
	9	J		9	W		9	j		9	<i>u</i>
	10	K		10	X		10	<i>k</i>		10	<i>v</i>
	11	L		11	Y		11	l		11	<i>w</i>
	12	M		12	Z		12	$\#$		12	<i>x</i>

■ PIN ASSIGNMENT

- C1 series

SIP type

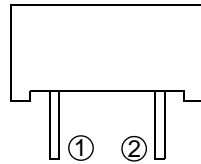

CHIP type

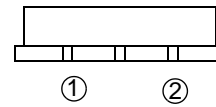

(Equivalent circuit)

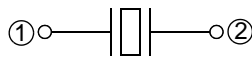

- C3 and C4 series

SIP type

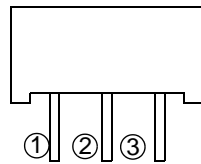

CHIP type

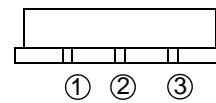

(Equivalent circuit)

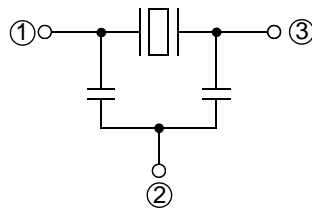

FAR Family (C1, C3, C4 series)

■ DIMENSIONS

Table 1 Package size

Unit: mm (in.)

Type		L	L1	W	H	a	
						Two terminal	Three terminal
SIP type	A	11.0 ± 0.2 (0.433 ± 0.008)	—	4.3 ± 0.2 (0.169 ± 0.008)	6.3 ± 0.2 (0.248 ± 0.008)	5.08 ± 0.2 (0.200 ± 0.008)	2.54 ± 0.2 (0.100 ± 0.008)
	B	9.0 ± 0.2 (0.354 ± 0.008)	—	4.3 ± 0.2 (0.169 ± 0.008)	5.3 ± 0.2 (0.209 ± 0.008)		
CHIP type	A	10.0 ± 0.5 (0.394 ± 0.020)	9.4 ± 0.2 (0.370 ± 0.008)	4.5 ± 0.5 (0.177 ± 0.020)	2.5 ± 0.3 (0.098 ± 0.012)		
	B	8.0 ± 0.5 (0.315 ± 0.020)	7.4 ± 0.2 (0.291 ± 0.008)	3.2 ± 0.5 (0.126 ± 0.020)	2.5 ± 0.3 (0.098 ± 0.012)		

SIP type

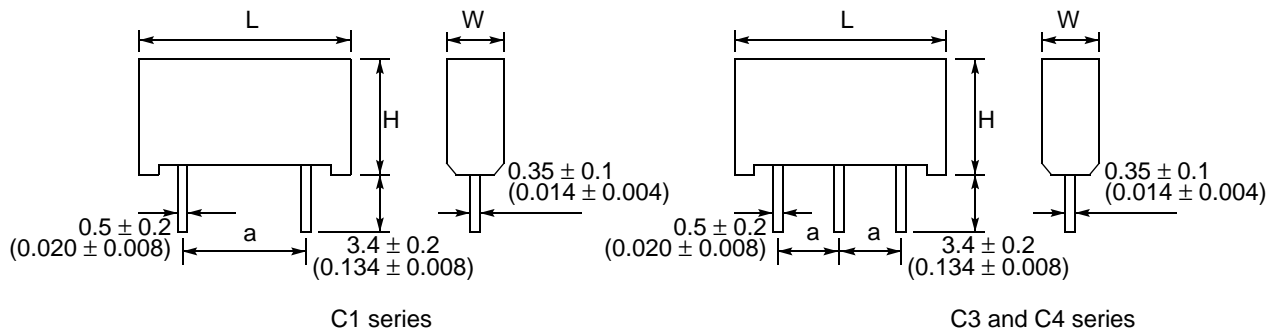

CHIP type

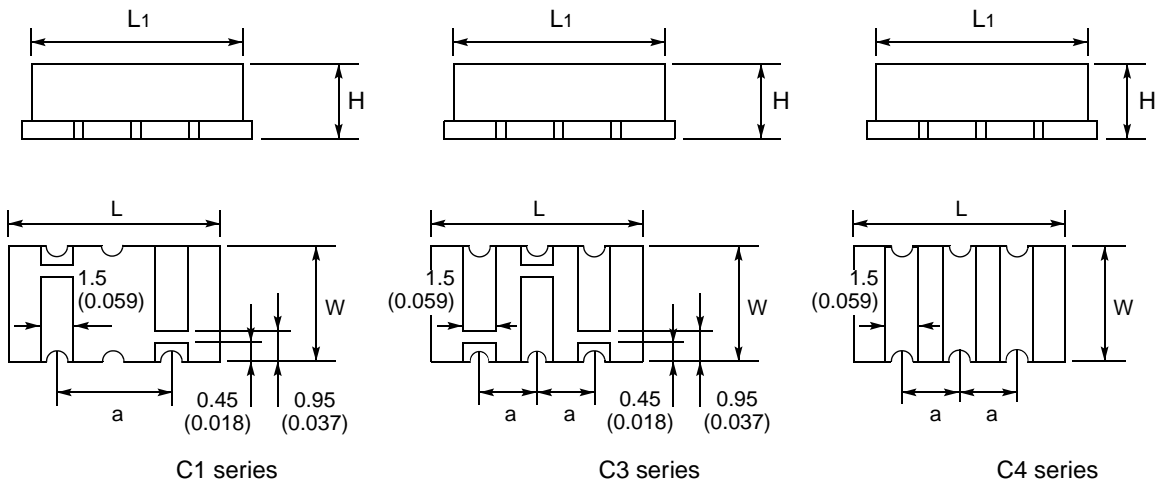

FAR Family (C1, C3, C4 series)

■ TAPING FORM AND DIMENSIONS

• SIP type

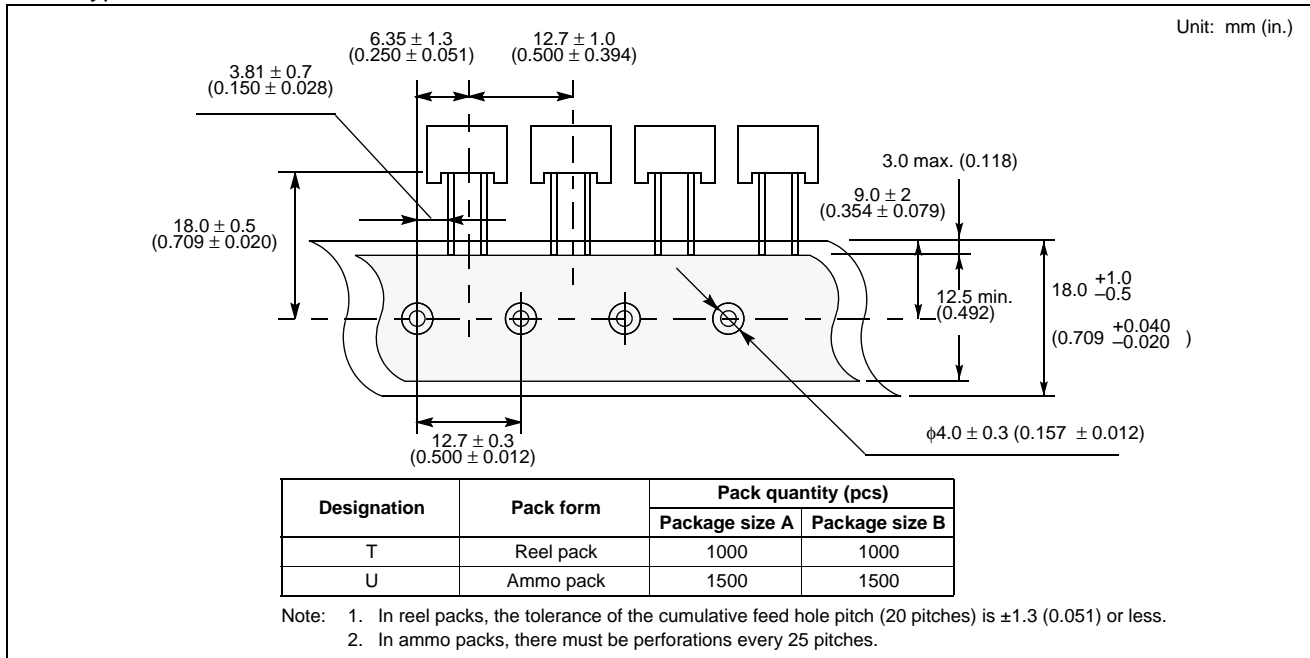

• CHIP type

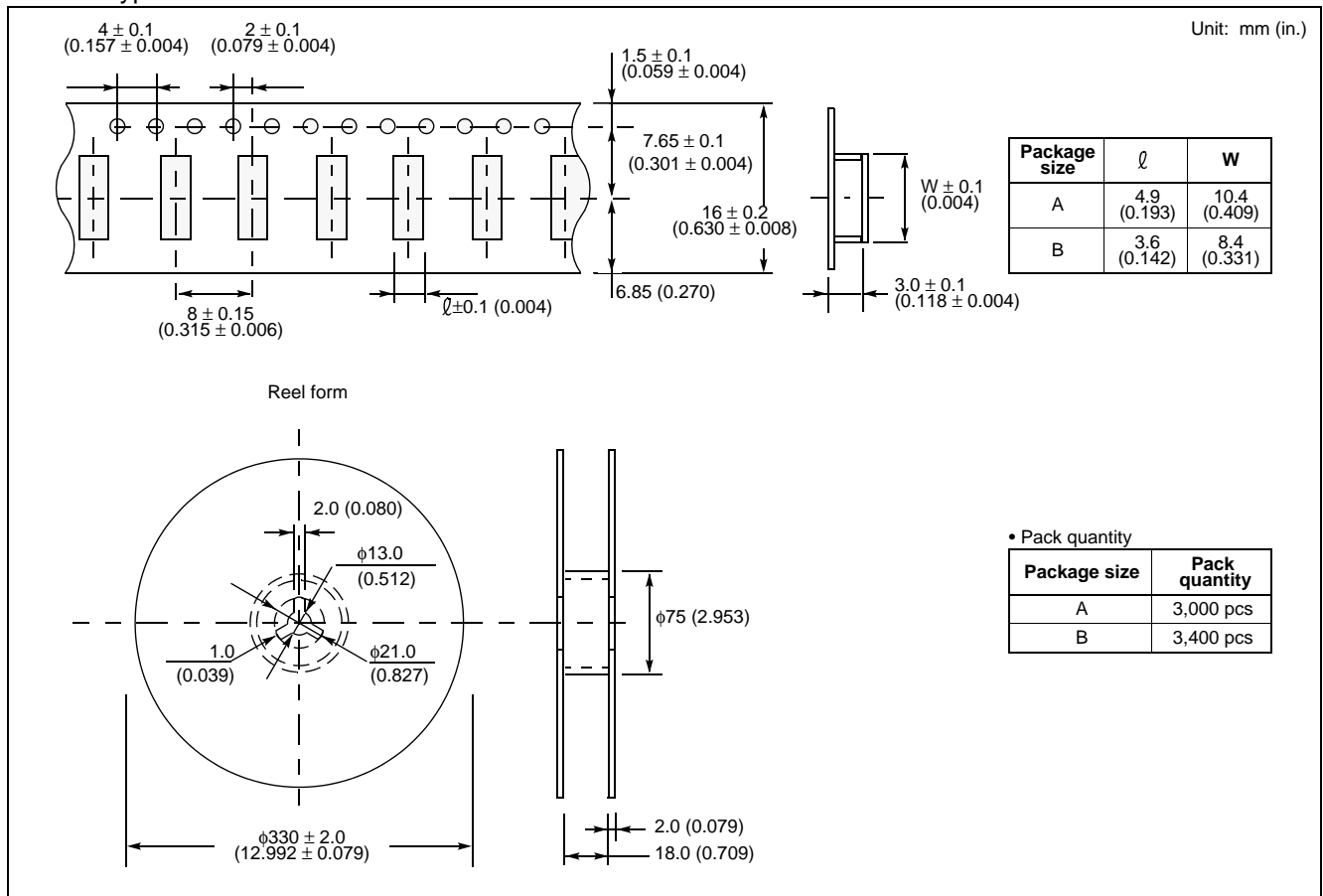

FAR Family (C1, C3, C4 series)

APPLICATION EXAMPLES

- C1 series

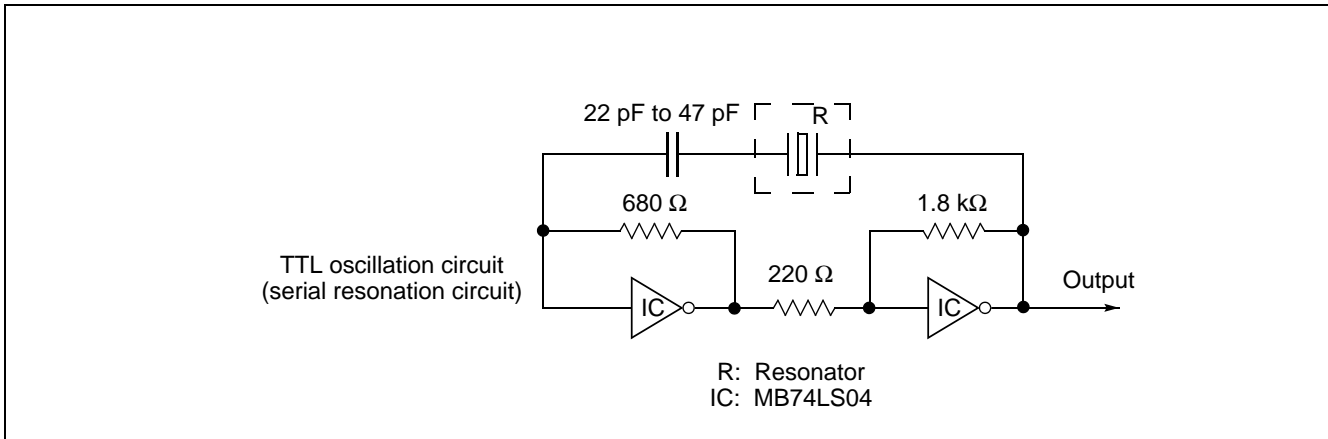

- C3, C4 series

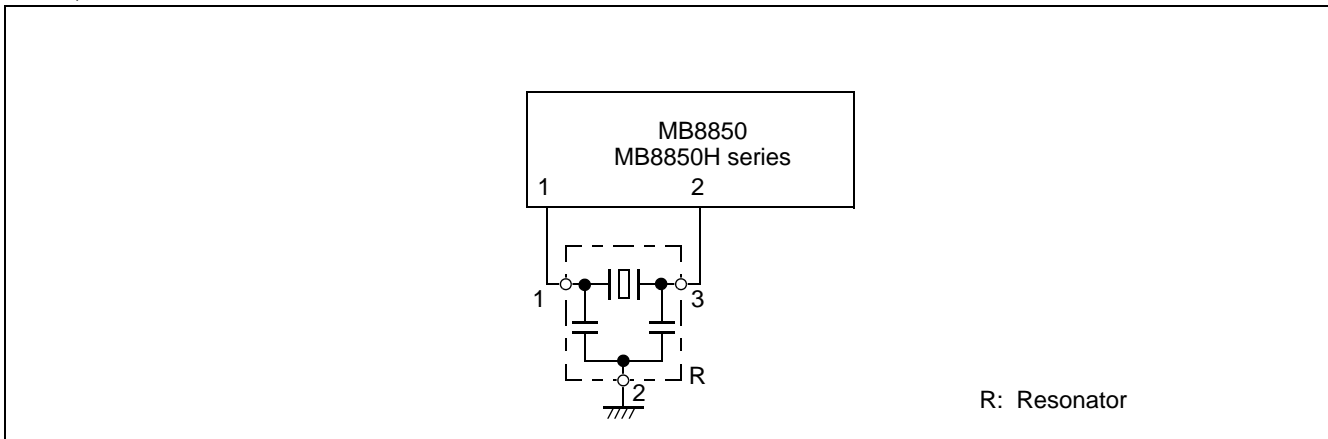

RELIABILITY

Parameter	Test conditions	Requirements
Shock	MIL-STD-883B, 2002, condition C (3000G)	Frequency fluctuation: within $\pm 0.1\%$
Vibration	MIL-STD-202E, 201A (1.5 mm <0.059> at 10 Hz to 55 Hz for 2 hours)	Frequency fluctuation: within $\pm 0.1\%$
Drop	5 times drop from 1 m (39.370 in.) height to wooden board.	Frequency fluctuation: within $\pm 0.1\%$
Sealing	Immersion in water at 85°C	No bubbles observed
Heat resistance	MIL-STD-202E, 210A condition B (260°C • 5 sec.)	Frequency fluctuation: within $\pm 0.1\%$
Temperature cycling	MIL-STD-883B, 1010, condition A (-35 to 85°C, 10 cycle)	Frequency fluctuation: within $\pm 0.1\%$
High-temperature loading test	MIL-STD-883B, 1008, condition B 1000 h (100°C • 1000 hours)	Frequency fluctuation: within $\pm 0.1\%$
High-temperature humidity test	MIL-STD-202E, 103A, condition B (96 hours at 60°C, 90% to 95% RH, 12 VDC)	Frequency fluctuation: within $\pm 0.1\%$

FUJITSU LIMITED

For further information please contact:

Japan

FUJITSU MEDIA DEVICES LIMITED
Marketing and Technical Support Dept.
SHINYOKOHAMA SQUARE BLDG
2-3-12, Shin-yokohama,
Kouhoku-ku, Yokohama-shi,
Kanagawa 222-0033, Japan
Tel: +81-45-471-0067
Fax: +81-45-471-0069

<http://www.fujitsu.co.jp/hypertext/fmd/English/index.html>

North and South America

FUJITSU MICROELECTRONICS, INC.
3545 North First Street,
San Jose, CA 95134-1804, U.S.A.
Tel: +1-408-922-9000
Fax: +1-408-922-9179

Customer Response Center
Mon. - Fri.: 7 am - 5 pm (PST)
Tel: +1-800-866-8608
Fax: +1-408-922-9179

<http://www.fujitsumicro.com/>

Europe

FUJITSU MICROELECTRONICS EUROPE GmbH
Am Siebenstein 6-10,
D-63303 Dreieich-Buchsschlag,
Germany
Tel: +49-6103-690-0
Fax: +49-6103-690-122

<http://www.fujitsu-fme.com/>

Asia Pacific

FUJITSU MICROELECTRONICS ASIA PTE. LTD.
#05-08, 151 Lorong Chuan,
New Tech Park,
Singapore 556741
Tel: +65-281-0770
Fax: +65-281-0220

<http://www.fmap.com.sg/>

F9703

© FUJITSU LIMITED Printed in Japan

All Rights Reserved.

The contents of this document are subject to change without notice. Customers are advised to consult with FUJITSU sales representatives before ordering.

The information and circuit diagrams in this document are presented as examples of semiconductor device applications, and are not intended to be incorporated in devices for actual use. Also, FUJITSU is unable to assume responsibility for infringement of any patent rights or other rights of third parties arising from the use of this information or circuit diagrams.

The contents of this document may not be reproduced or copied without the permission of FUJITSU LIMITED.

FUJITSU semiconductor devices are intended for use in standard applications (computers, office automation and other office equipments, industrial, communications, and measurement equipments, personal or household devices, etc.).

CAUTION:

Customers considering the use of our products in special applications where failure or abnormal operation may directly affect human lives or cause physical injury or property damage, or where extremely high levels of reliability are demanded (such as aerospace systems, atomic energy controls, sea floor repeaters, vehicle operating controls, medical devices for life support, etc.) are requested to consult with FUJITSU sales representatives before such use. The company will not be responsible for damages arising from such use without prior approval.

Any semiconductor devices have inherently a certain rate of failure. You must protect against injury, damage or loss from such failures by incorporating safety design measures into your facility and equipment such as redundancy, fire protection, and prevention of over-current levels and other abnormal operating conditions.

If any products described in this document represent goods or technologies subject to certain restrictions on export under the Foreign Exchange and Foreign Trade Control Law of Japan, the prior authorization by Japanese government should be required for export of those products from Japan.